



# **iVMS-4200 Client**

**User Manual**

## Legal Information

©2022 Hangzhou Hikvision Digital Technology Co., Ltd. All rights reserved.

### About this Manual

The Manual includes instructions for using and managing the Product. Pictures, charts, images and all other information hereinafter are for description and explanation only. The information contained in the Manual is subject to change, without notice, due to firmware updates or other reasons. Please find the latest version of this Manual at the Hikvision website ( <https://www.hikvision.com/> ).

Please use this Manual with the guidance and assistance of professionals trained in supporting the Product.

### Trademarks

**HIKVISION** and other Hikvision's trademarks and logos are the properties of Hikvision in various jurisdictions.

Other trademarks and logos mentioned are the properties of their respective owners.

### Disclaimer

TO THE MAXIMUM EXTENT PERMITTED BY APPLICABLE LAW, THIS MANUAL AND THE PRODUCT DESCRIBED, WITH ITS HARDWARE, SOFTWARE AND FIRMWARE, ARE PROVIDED "AS IS" AND "WITH ALL FAULTS AND ERRORS". HIKVISION MAKES NO WARRANTIES, EXPRESS OR IMPLIED, INCLUDING WITHOUT LIMITATION, MERCHANTABILITY, SATISFACTORY QUALITY, OR FITNESS FOR A PARTICULAR PURPOSE. THE USE OF THE PRODUCT BY YOU IS AT YOUR OWN RISK. IN NO EVENT WILL HIKVISION BE LIABLE TO YOU FOR ANY SPECIAL, CONSEQUENTIAL, INCIDENTAL, OR INDIRECT DAMAGES, INCLUDING, AMONG OTHERS, DAMAGES FOR LOSS OF BUSINESS PROFITS, BUSINESS INTERRUPTION, OR LOSS OF DATA, CORRUPTION OF SYSTEMS, OR LOSS OF DOCUMENTATION, WHETHER BASED ON BREACH OF CONTRACT, TORT (INCLUDING NEGLIGENCE), PRODUCT LIABILITY, OR OTHERWISE, IN CONNECTION WITH THE USE OF THE PRODUCT, EVEN IF HIKVISION HAS BEEN ADVISED OF THE POSSIBILITY OF SUCH DAMAGES OR LOSS.

YOU ACKNOWLEDGE THAT THE NATURE OF THE INTERNET PROVIDES FOR INHERENT SECURITY RISKS, AND HIKVISION SHALL NOT TAKE ANY RESPONSIBILITIES FOR ABNORMAL OPERATION, PRIVACY LEAKAGE OR OTHER DAMAGES RESULTING FROM CYBER-ATTACK, HACKER ATTACK, VIRUS INFECTION, OR OTHER INTERNET SECURITY RISKS; HOWEVER, HIKVISION WILL PROVIDE TIMELY TECHNICAL SUPPORT IF REQUIRED.

YOU AGREE TO USE THIS PRODUCT IN COMPLIANCE WITH ALL APPLICABLE LAWS, AND YOU ARE SOLELY RESPONSIBLE FOR ENSURING THAT YOUR USE CONFORMS TO THE APPLICABLE LAW. ESPECIALLY, YOU ARE RESPONSIBLE, FOR USING THIS PRODUCT IN A MANNER THAT DOES NOT INFRINGE ON THE RIGHTS OF THIRD PARTIES, INCLUDING WITHOUT LIMITATION, RIGHTS OF PUBLICITY, INTELLECTUAL PROPERTY RIGHTS, OR DATA PROTECTION AND OTHER PRIVACY RIGHTS. YOU SHALL NOT USE THIS PRODUCT FOR ANY PROHIBITED END-USES, INCLUDING THE

DEVELOPMENT OR PRODUCTION OF WEAPONS OF MASS DESTRUCTION, THE DEVELOPMENT OR PRODUCTION OF CHEMICAL OR BIOLOGICAL WEAPONS, ANY ACTIVITIES IN THE CONTEXT RELATED TO ANY NUCLEAR EXPLOSIVE OR UNSAFE NUCLEAR FUEL-CYCLE, OR IN SUPPORT OF HUMAN RIGHTS ABUSES.

IN THE EVENT OF ANY CONFLICTS BETWEEN THIS MANUAL AND THE APPLICABLE LAW, THE LATTER PREVAILS.

## Port List

Before installing iVMS-4200 Client Software service, ensure the default ports of the iVMS-4200 Client Software are not used by other services, otherwise the iVMS-4200 Client Software service will be unavailable.



For more details about port list, enter Hikvision official website (<http://www.hikvision.com>) or scan the QR code below to get more details.





## Symbol Conventions

The symbols that may be found in this document are defined as follows.

Symbol	Description
 <b>Danger</b>	Indicates a hazardous situation which, if not avoided, will or could result in death or serious injury.
 <b>Caution</b>	Indicates a potentially hazardous situation which, if not avoided, could result in equipment damage, data loss, performance degradation, or unexpected results.
 <b>Note</b>	Provides additional information to emphasize or supplement important points of the main text.

# Contents

<b>Chapter 1 Overview .....</b>	<b>1</b>
1.1 Introduction .....	1
1.2 Summary of Changes .....	1
<b>Chapter 2 Service Management .....</b>	<b>2</b>
<b>Chapter 3 Device Management .....</b>	<b>3</b>
3.1 Activate Devices .....	3
3.2 Add Device .....	4
3.2.1 Add Single or Multiple Online Devices .....	4
3.2.2 Add Device by IP Address or Domain Name .....	7
3.2.3 Add Devices by IP Segment .....	10
3.2.4 Add Device by Hik-Connect .....	12
3.2.5 Add Device by ISUP Account .....	13
3.2.6 Import Devices in a Batch .....	14
3.3 Restore/Reset Device Password .....	15
3.3.1 Reset Device Password .....	15
3.3.2 Restore Device's Default Password .....	16
3.4 Upgrade Device Firmware Version .....	17
3.5 Manage Added Devices .....	19
3.6 Group Management .....	20
3.6.1 Group Resources .....	21
3.6.2 Edit Resource Parameters .....	22
<b>Chapter 4 Hik-Connect .....</b>	<b>24</b>
4.1 Register a Hik-Connect Account .....	24
4.2 Log into Hik-Connect Account .....	25
<b>Chapter 5 Live View .....</b>	<b>26</b>
5.1 Live View Toolbar .....	26

5.2 Add Custom View .....	27
5.3 Start Live View .....	28
5.4 Auto-Switch in Live View .....	29
5.4.1 Auto-Switch Cameras in a Group .....	30
5.4.2 Auto-Switch All Cameras .....	31
5.4.3 Auto-Switch Custom Views .....	32
5.5 Object Missing .....	33
5.5.1 PTZ Control Panel .....	34
5.5.2 Set Preset, Patrol, and Pattern .....	36
5.6 Customize Window Division .....	37
5.7 Manually Record and Capture .....	38
5.7.1 Manually Record Video .....	38
5.7.2 View Local Videos .....	39
5.7.3 Capture Pictures .....	39
5.7.4 View Captured Pictures .....	40
5.8 Instant Playback .....	40
5.9 Live View for Fisheye Camera .....	41
5.9.1 Perform Live View in Fisheye Mode .....	41
5.9.2 PTZ Control in Fisheye Mode .....	42
5.9.3 Set a Preset and Patrol .....	43
5.10 Perform Smart Linkage .....	43
5.10.1 Configure Smart Linkage Rule .....	44
5.10.2 Enable Smart Linkage .....	46
5.11 Live View for Thermal Camera .....	46
5.11.1 View Fire Source Information during Live View .....	46
5.11.2 Show Temperature Information on Live View Image .....	48
5.11.3 Manually Measure Temperature .....	49
5.11.4 Display Fire Source Detection Shield Area .....	50

5.11.5 Display Waste Gas Information .....	50
5.12 Live View in Low Bandwidth .....	51
5.13 More Functions .....	51
<b>Chapter 6 Remote Playback .....</b>	<b>53</b>
6.1 Flow Chart .....	53
6.2 Remote Storage Configuration .....	54
6.2.1 Store Picture and Video on DVR, NVR, or Network Camera .....	54
6.2.2 Store Video on Storage Device .....	56
6.2.3 Store Picture and Additional Information on Local PC .....	57
6.2.4 Configure Recording Schedule Template .....	58
6.2.5 Configure Capture Schedule Template .....	59
6.3 Toolbar for Playback .....	60
6.4 Normal Playback .....	61
6.4.1 Search Video Footage .....	62
6.4.2 Play Video Footage .....	63
6.5 Alarm Input Playback .....	65
6.5.1 Search Video Footage .....	65
6.5.2 Play Video Footage .....	65
6.6 Event Playback .....	66
6.6.1 Search Video Footage/Picture .....	66
6.6.2 View Video Footage/Picture .....	67
6.7 ATM Playback .....	68
6.7.1 Search Video Footage .....	68
6.7.2 Play Video Footage .....	68
6.8 POS Playback .....	69
6.8.1 Search Video Footage .....	69
6.8.2 Play Video Footage .....	70
6.9 VCA Playback .....	70

6.10 Synchronous Playback .....	72
6.11 Fisheye Camera's Video Playback .....	72
6.12 Playback in Low Bandwidth .....	74
6.13 Download Video Footage .....	74
6.13.1 Download Video Footage by Date .....	74
6.13.2 Download for Multiple Cameras .....	75
<b>Chapter 7 Event Configuration .....</b>	<b>76</b>
7.1 Configure Event for Camera .....	76
7.2 Configure Event for Alarm Input .....	78
7.3 Configure Event for Encoding Device .....	80
<b>Chapter 8 Event Center .....</b>	<b>82</b>
8.1 Enable Receiving Event from Devices .....	82
8.2 View Real-Time Events .....	83
8.3 Search Historical Events .....	85
8.4 Get Events from Device .....	88
8.5 View Pop-up Event Information .....	89
<b>Chapter 9 Map Management .....</b>	<b>91</b>
9.1 Add Map .....	91
9.2 Edit Map Scale .....	92
9.3 Longitude and Latitude Calibration .....	93
9.4 Manage Hot Spot .....	93
9.4.1 Add Camera as Hot Spot .....	93
9.4.2 Add Alarm Input as Hot Spot .....	95
9.4.3 Add Alarm Output as Hot Spot .....	96
9.4.4 Add Zone as Hot Spot .....	98
9.4.5 Add Access Point as Hot Spot .....	100
9.4.6 Configure Security Radar Hot Spot .....	102
9.4.7 Edit Hot Spot .....	135

9.4.8 Preview Hot Spot .....	136
9.5 Manage Hot Region .....	139
9.5.1 Add Hot Region .....	139
9.5.2 Edit Hot Region .....	140
9.5.3 Preview Hot Region .....	140
9.6 View Person's Moving Pattern .....	141
<b>Chapter 10 Statistics .....</b>	<b>143</b>
10.1 People Counting Report .....	143
10.1.1 People Counting Report by Encoding Device .....	143
10.1.2 View People Counting Report by DeepinMind Server .....	147
10.2 View People Counting in Intersections Report .....	148
10.3 Queue Management .....	150
10.3.1 Queuing-Up Time Analysis .....	150
10.3.2 Queue Status Analysis .....	154
10.4 Heat Map Report .....	158
10.5 Report of Skin-Surface Temperature Statistics .....	160
10.6 Real-Time Density and People Counting .....	161
10.7 Temperature Map .....	163
<b>Chapter 11 Data Retrieval .....</b>	<b>165</b>
11.1 Face Picture Retrieval .....	165
11.1.1 Search Face by Uploaded Picture .....	165
11.1.2 Search Face by Event Type .....	167
11.1.3 Search Face by Person Name .....	170
11.1.4 Search Face by Facial Features .....	173
11.2 Human Body Retrieval .....	175
11.2.1 Search Human Body by Uploaded Picture .....	175
11.2.2 Search Human Body by Personnel Features .....	177
11.3 View Behavior Analysis Related Pictures and Videos .....	178

11.4 Vehicle Retrieval .....	180
11.5 Hard Hat Retrieval .....	182
11.6 People Frequency Search .....	183
11.6.1 Search Frequently Appeared Person .....	183
11.6.2 Search Rarely Appeared Person .....	184
11.7 AI Dashboard Retrieval .....	185
11.7.1 Search Analysis Result for Video and Captured Picture Task .....	186
11.7.2 Search Analysis Result for Imported Picture Task .....	187
11.8 Facial Recognition Check-in .....	188
11.8.1 Search Facial Recognition Check-in Records .....	189
11.8.2 Search Facial Recognition Attendance Records .....	190
11.9 Community Inspection .....	192
11.9.1 Detect Fire Engine Access .....	192
11.9.2 Detect Elevator .....	193
11.9.3 Retrieve Urban Management Event .....	194
<b>Chapter 12 AI Dashboard .....</b>	<b>196</b>
12.1 Face Application .....	196
12.1.1 Set List Types for Face Picture Libraries .....	196
12.1.2 Set Cameras for Showing AI Information .....	197
12.1.3 Show AI Information .....	197
12.2 Multi-Target-Type Detection .....	198
12.2.1 Set Target Detection Parameters .....	199
12.2.2 Display Multi-Target-Type Detection .....	202
12.3 AI Open Platform .....	203
12.3.1 Configure Platform Parameters .....	204
12.3.2 Analyze Picture Task .....	206
12.3.3 AI Platform Real-Time Display .....	207
12.4 Linked Capture Alarm .....	208

12.4.1 Set Basic Parameters .....	209
12.4.2 View Live View and Alarms .....	209
12.5 Traffic Accident Alarm .....	210
12.5.1 Object Missing .....	210
12.5.2 View Traffic Accident Alarm .....	210
12.6 Arming and Tracking .....	211
12.6.1 Vehicle Arming and Control .....	212
12.6.2 Face/Human Body Arming and Control .....	213
12.7 Skin-Surface Temperature .....	215
12.7.1 Display Skin-Surface Temperature .....	215
12.7.2 Skin-Surface Temperature Information Display .....	216
12.7.3 View Alarm Information .....	220
12.8 Behavior Analysis .....	221
12.9 Behavior Analysis Overview .....	223
12.10 Customer Traffic (Face) .....	224
<b>Chapter 13 Security Control Panel .....</b>	<b>227</b>
13.1 Flow Chart .....	227
13.2 Object Missing .....	228
13.3 Configure Client Linkage for Zone Event .....	228
13.4 Remotely Control Security Control Panel .....	230
13.4.1 Remotely Control Partitions .....	230
13.4.2 Remotely Control Zones .....	231
13.4.3 Remotely Control Relay .....	232
13.4.4 Remotely Control Siren .....	233
<b>Chapter 14 Person Management .....</b>	<b>234</b>
14.1 Add Organization .....	234
14.2 Add Single Person .....	234
14.2.1 Configure Basic Information .....	235



14.2.2 Issue a Card to One Person .....	236
14.2.3 Upload a Face Photo from Local PC .....	240
14.2.4 Take a Photo via Client .....	241
14.2.5 Collect Face via Access Control Device .....	242
14.2.6 Collect Fingerprint via Client .....	243
14.2.7 Collect Fingerprint via Access Control Device .....	244
14.2.8 Collect Iris via Client .....	245
14.2.9 Collect Iris via Access Control Device .....	245
14.2.10 Configure Access Control Information .....	246
14.2.11 Customize Person Information .....	247
14.2.12 Configure Resident Information .....	248
14.2.13 Configure Additional Information .....	248
14.3 Import and Export Person Identify Information .....	249
14.3.1 Import Person Information .....	249
14.3.2 Import Person Pictures .....	250
14.3.3 Export Person Information .....	250
14.3.4 Export Person Pictures .....	251
14.4 Get Person Information from Access Control Device .....	251
14.5 Move Persons to Another Organization .....	252
14.6 Issue Cards to Persons in Batch .....	253
14.7 Report Card Loss .....	253
14.8 Object Missing .....	254
<b>Chapter 15 Access Control .....</b>	<b>255</b>
15.1 Flow Chart .....	255
15.2 Configure Schedule and Template .....	256
15.2.1 Add Holiday .....	257
15.2.2 Add Template .....	257
15.3 Set Access Group to Assign Access Authorization to Persons .....	259

15.4 Search Access Group .....	261
15.5 Configure Advanced Functions .....	262
15.5.1 Configure Device Parameters .....	262
15.5.2 Configure Remaining Unlocked/Locked .....	270
15.5.3 Configure Multi-Factor Authentication .....	271
15.5.4 Configure Custom Wiegand Rule .....	274
15.5.5 Configure Card Reader Authentication Mode and Schedule .....	275
15.5.6 Configure Person Authentication Mode .....	277
15.5.7 Configure Relay for Elevator Controller .....	278
15.5.8 Configure First Person In .....	282
15.5.9 Configure Anti-Passback .....	283
15.5.10 Configure Multi-door Interlocking .....	284
15.5.11 Configure Authentication Code .....	285
15.6 Configure Other Parameters .....	286
15.6.1 Set Multiple NIC Parameters .....	286
15.6.2 Set Network Parameters .....	286
15.6.3 Set Device Capture Parameters .....	288
15.6.4 Set Parameters for Face Recognition Terminal .....	290
15.6.5 Enable M1 Card Encryption .....	291
15.6.6 Set RS-485 Parameters .....	291
15.6.7 Set Wiegand Parameters .....	292
15.7 Configure Linkage Actions for Access Control .....	292
15.7.1 Configure Client Actions for Access Event .....	292
15.7.2 Configure Device Actions for Access Event .....	294
15.7.3 Configure Device Actions for Card Swiping .....	295
15.7.4 Configure Device Actions for Person ID .....	296
15.8 Door/Elevator Control .....	298
15.8.1 Control Door Status .....	298

15.8.2 Control Elevator Status .....	299
15.8.3 Check Real-Time Access Records .....	300
<b>Chapter 16 Time and Attendance .....</b>	<b>303</b>
16.1 Flow Chart .....	303
16.2 Configure Attendance Parameters .....	304
16.2.1 Set Weekend .....	304
16.2.2 Object Missing .....	305
16.2.3 Configure Overtime Parameters .....	305
16.2.4 Configure Attendance Check Point .....	305
16.2.5 Configure Holiday .....	306
16.2.6 Configure Leave Type .....	308
16.2.7 Synchronize Authentication Record to Third-Party Database .....	308
16.2.8 Configure Attendance Calculation Accuracy .....	309
16.2.9 Configure Break Time .....	310
16.3 Add Flexible Timetable .....	311
16.4 Add General Timetable .....	313
16.5 Add Shift .....	316
16.6 Manage Shift Schedule .....	319
16.6.1 Set Department Schedule .....	319
16.6.2 Set Person Schedule .....	320
16.6.3 Set Temporary Schedule .....	321
16.6.4 Check Shift Schedule .....	322
16.7 Manually Correct Check-in/out Record .....	322
16.8 Add Leave and Business Trip .....	323
16.9 Calculate Attendance Data .....	324
16.9.1 Automatically Calculate Attendance Data .....	325
16.9.2 Manually Calculate Attendance Data .....	325
16.10 Attendance Statistics .....	326

16.10.1 Get an Overview of Employees' Attendance Data .....	326
16.10.2 Custom Export Attendance Records .....	327
16.10.3 Configure Report Display .....	328
16.10.4 Generate Instant Report .....	328
16.10.5 Send Report Regularly .....	329
<b>Chapter 17 Video Intercom .....</b>	<b>331</b>
17.1 Flow Chart .....	331
17.2 Manage Calls between Client Software and an Indoor/Door Station/Access Control Device .....	332
17.2.1 Call Indoor Station from Client .....	332
17.2.2 Answer Call via Client .....	333
17.3 View Real-Time Call Logs .....	334
17.4 Release a Notice to Resident .....	335
17.5 Configure Video Intercom Event .....	335
17.6 Enable Calling between Video Intercom Device and Client .....	337
17.7 Object Missing .....	337
<b>Chapter 18 Object Missing .....</b>	<b>338</b>
18.1 Topology Display Overview .....	338
18.2 Set Topology Parameters .....	339
18.3 View Device Details .....	340
18.4 View Link Details .....	341
18.5 Object Missing .....	342
18.6 Export Topology .....	343
18.7 Object Missing .....	343
<b>Chapter 19 Log Search .....</b>	<b>344</b>
<b>Chapter 20 User Management .....</b>	<b>345</b>
20.1 Add User .....	345
20.2 Change User's Password .....	346

<b>Chapter 21 System Configuration .....</b>	<b>347</b>
21.1 Set General Parameters .....	347
21.2 Set Live View and Playback Parameters .....	348
21.3 Set Image Parameters .....	349
21.4 Set Picture Storage .....	351
21.5 Set Alarm Sound .....	351
21.6 Set Access Control and Video Intercom Parameters .....	351
21.7 Set File Saving Path .....	352
21.8 Set Icons Shown on Toolbar .....	352
21.9 Set Keyboard and Joystick Shortcuts .....	354
21.10 Set Email Parameters .....	354
21.11 Manage Security Authentication .....	355
21.11.1 Export Certificate from Service Management .....	355
21.11.2 Import Certificate to Client .....	356
21.11.3 Certificate Verification for Transmission Encryption .....	356
<b>Chapter 22 Operation and Maintenance .....</b>	<b>357</b>
<b>Appendix A. Custom Wiegand Rule Descriptions .....</b>	<b>358</b>
<b>Appendix B. Troubleshooting .....</b>	<b>360</b>
B.1 Failed to get the live view of a certain device. ....	360
B.2 Local recording and remote recording are confused. ....	360
B.3 Failed to download the video files or the downloading speed is too slow. ....	360
<b>Appendix C. FAQ (Frequently Asked Questions) .....</b>	<b>362</b>
C.1 During live view, why an error message with error code 91 prompts ? .....	362
C.2 During live view, why the image is blurred or not fluent? .....	362
C.3 Why the memory leaked and the client crashed after running for a while? .....	362
C.4 How to get better performance of live view and playback when network bandwidth is low? .....	363
<b>Appendix D. Error Code .....</b>	<b>365</b>

# Chapter 1 Overview

## 1.1 Introduction

iVMS-4200 Client Software is designed to configure and manage Hikvision devices in a unified and intuitive manner, including DVRs, NVRs, IP cameras, encoders, decoders, security control panels, video intercom devices, access control devices, etc.

The software provides multiple functionalities, including real-time live view, video recording, remote search and playback, file backup, alarm receiving, person management, access control, video intercom, security control, time & attendance, etc.

This user manual describes the functions, configurations and operation steps of the client software. To ensure the properness of usage and stability of the software, refer to the contents below and read the manual carefully before installation and operation.

## 1.2 Summary of Changes

The followings are the key changes between this version and the previous version.

- Deleted the content of adding device by HiDDNS.
- Added the function of longitude and latitude calibration on the E-map. For details, refer to ***Longitude and Latitude Calibration*** .
- Added the statistics type of device grouping statistics for the people counting report by encoding device. For details, refer to ***People Counting Report by Encoding Device*** .
- Added the supported model of card enrollment station. For details, refer to ***Issue a Card by Local Mode*** .
- Added the function of customer traffic (face). For details, refer to ***Customer Traffic (Face)*** .
- Added the selection of card reader ID for collecting face via access control device, For details, refer to ***Collect Face via Access Control Device*** .
- Added two modes for the configuration of remaining unlocked/locked. For details, refer to ***Configure Remaining Unlocked/Locked*** .
- Added parameters for the function of **Enable Remaining Open after First Person**. For details, refer to ***Configure First Person In*** .

## Chapter 2 Service Management

iVMS-4200 Service is mainly applicable for data storage, data management, and data calculation. With continuous running and processing, it can manage the data, such as event records and attendance records, received by the iVMS-4200 Client Software. iVMS-4200 Service also provides management for user permissions, devices, groups, logs, etc.

You can view the module running status, and click **Edit Port** to edit its ports. You need to restart the iVMS-4200 Service to take effect.

Enter the ISUP port number configured on the router, so that you will be able to add ISUP devices to the client for management.

Check **WAN Address**, and enter the **IP Address** for port mapping, or edit **Event Uploading Port (ISUP 4.0)**, **Event Uploading Port (ISUP 5.0)**, **Picture Storage Server Port**, **Live View Port**, **Live View Port of Video Intercom**, **Two-Way Audio Port**, and **Playback Port**.

Check **Auto-Launch** to enable launching the iVMS-4200 Service automatically after the PC started up.

The iVMS-4200 Service will not show after running it. Enter the system tray and click  to open the service management window.

---

### Note

- After closing the service window, the client will log out and return to the login page. You need to run the service and then log in again.
  - The client can be run by no more than one operating system user at the same time on the same computer.
  - The Service should run on the same computer with the client.
-

## Chapter 3 Device Management

The client supports various types of devices including network camera, DVR (Digital Video Recorder), NVR (Network Video Recorder), security control panel, video intercom device, access control device, etc.

### Example

You can view live view or playback after adding encoding devices to the client; you can arm or disarm zones of a security control panel, receive alarm notifications after adding a security control panel to the client; and you can control entrance & exit and manage attendance after adding access control devices to the client.

### 3.1 Activate Devices

For the inactive devices, you are required to create a password to activate them before they can be added to the software and work properly.

#### Before You Start

Make sure the device to be activated is connected to the network and on the same subnet with the PC where the client runs.

#### Steps

#### Note

This function should be supported by the device.

1. Enter the Device Management page.
2. Click **Device** on the top of the right panel.
3. Click **Online Device** to show the online device list at the bottom of the page.  
The searched online devices are displayed in the list.
4. Check the device status (shown on **Security Level** column) and select an inactive device.

IPv4	IPv6	Device Model	Firmware Version	Security Level	Port	Enhancement	Serial No.	Boot Time	Added	Support	Hik-Co...	Operation
[Redacted]	::		V5.4.0build 160218	Inactive	8000	N/A	[Redacted]	2021-06-1...	No	N/A	N/A	[Icons]

Figure 3-1 Online Inactive Device

5. Click **Activate** to open the Activation dialog.
6. Create a password in the password field, and confirm the password.





## Caution

The password strength of the device can be automatically checked. We highly recommend you change the password of your own choosing (using a minimum of 8 characters, including at least three kinds of following categories: upper case letters, lower case letters, numbers, and special characters) in order to increase the security of your product. And we recommend you change your password regularly, especially in the high security system, changing the password monthly or weekly can better protect your product.

Proper configuration of all passwords and other security settings is the responsibility of the installer and/or end-user.

---



## Note

For the NVR device, you are required to create a password in **Network Cameras' Default Password** field and confirm the password for activating network camera(s) connected to the NVR.

---

7. **Optional:** Enable Hik-Connect service when activating the device if the device supports.
    - 1) Check **Enable Hik-Connect** to open the Note dialog.
    - 2) Create a verification code, and confirm the verification code.
    - 3) Click **Terms of Service** and **Privacy Policy** to read the requirements.
    - 4) Click **OK** to enable the Hik-Connect service.
  8. Click **OK** to activate the device.
- 



## Note

If the device supports resetting password via the reserved email, security question, or GUID, you can configure them after activating the device.

---

9. **Optional:** Click  in the Operation column to edit the network information (including IP address, port number, gateway, etc.) for the online device.

## 3.2 Add Device

The client provides various device adding modes including IP/domain, IP segment, cloud P2P, ISUP protocol. The client also supports importing multiple devices in a batch when there are large amount of devices to be added.

### 3.2.1 Add Single or Multiple Online Devices

The client can detect online devices which are in the same network as the PC running the client. You can select a detected online device displayed in the online device list and add it to the client. For detected online devices sharing the same user name and password, you can add them to the client in a batch.

## Before You Start

- The device(s) to be added are in the same network as the PC running the client.
- The device(s) to be added have been activated.

## Steps

1. Click **Device Management** → **Device** → **Device** .
2. Click **Online Device** to show the online device area.  
The searched online devices are displayed in the list.

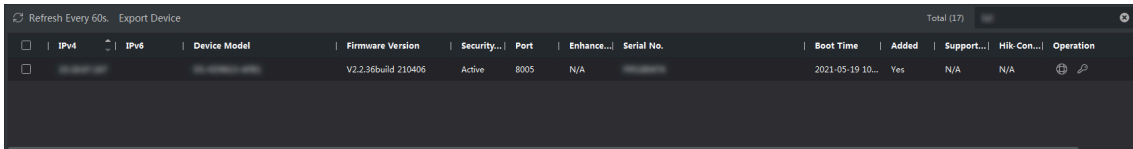

The screenshot shows a table of online devices. The table has columns for IPv4, IPv6, Device Model, Firmware Version, Security, Port, Enhance, Serial No., Boot Time, Added, Support, Hik Con, and Operation. A single device is listed with the following details:

IPv4	IPv6	Device Model	Firmware Version	Security	Port	Enhance	Serial No.	Boot Time	Added	Support	Hik Con	Operation
			V2.2.36build 210406	Active	8005	N/A		2021-05-19 10...	Yes	N/A	N/A	

Figure 3-2 Online Device

3. In the **Online Device** area, check one or more online device(s), and click **Add** to open the device adding window.

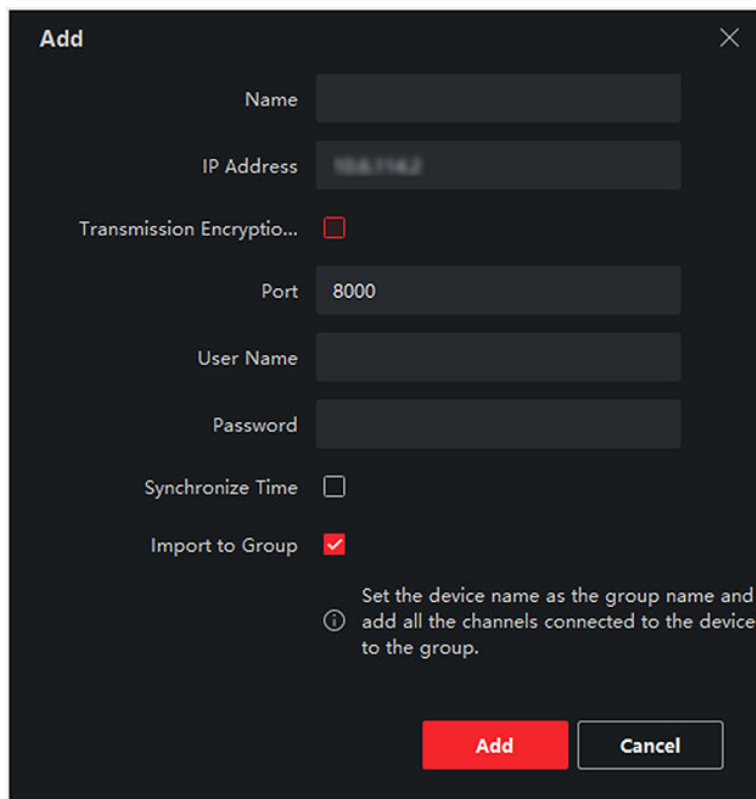

The 'Add' dialog box contains the following fields and options:

- Name: [Text Input]
- IP Address: 192.168.1.142
- Transmission Encryption:
- Port: 8000
- User Name: [Text Input]
- Password: [Text Input]
- Synchronize Time:
- Import to Group:

Below the 'Import to Group' checkbox, there is an information icon and the following text: "Set the device name as the group name and add all the channels connected to the device to the group."

At the bottom of the dialog, there are two buttons: "Add" (red) and "Cancel" (white).

Figure 3-3 Add Single Online Device

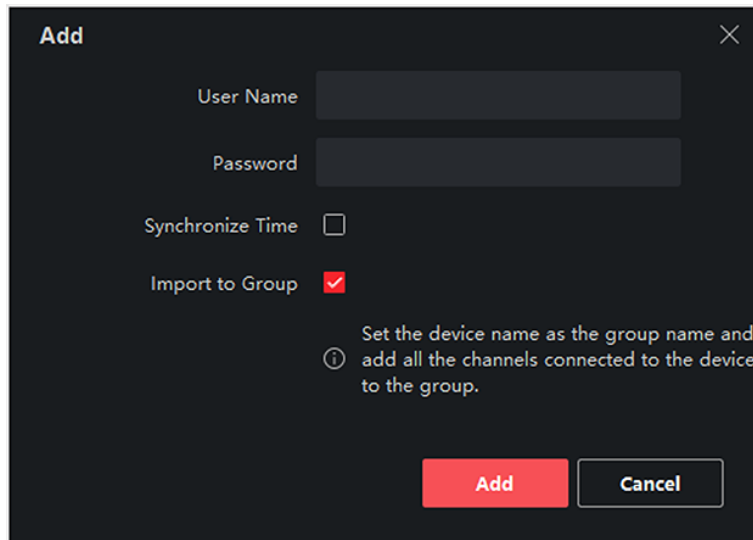

**Figure 3-4 Add Multiple Online Devices**

4. Enter the required information.

**Name**

Enter a descriptive name for the device.

**IP Address**

Enter the device's IP address. The IP address of the device is obtained automatically in this adding mode.

**Port**

You can customize the port number. The port number of the device is obtained automatically in this adding mode.



**Note**

For some device types, you can enter **80** as the port No. This function should be supported by the device.

---

**User Name**

By default, the user name is **admin**.

**Password**

Enter the device password.

---



**Caution**

The password strength of the device can be automatically checked. We highly recommend you change the password of your own choosing (using a minimum of 8 characters, including at least three kinds of following categories: upper case letters, lower case letters, numbers,

and special characters) in order to increase the security of your product. And we recommend you change your password regularly, especially in the high security system, changing the password monthly or weekly can better protect your product.

Proper configuration of all passwords and other security settings is the responsibility of the installer and/or end-user.

- 
5. **Optional:** Check **Transmission Encryption (TLS)** to enable transmission encryption using TLS (Transport Layer Security) protocol for security purpose.
- 

 **Note**

- This function should be supported by the device.
  - If you have enabled Certificate Verification, you should click **Open Certificate Directory** to open the default folder, and copy the certificate file exported from the device to this default directory to strengthen the security. See ***Certificate Verification for Transmission Encryption*** for details about enabling certificate verification.
  - You can log into the device to get the certificate file by web browser.
- 

6. Check **Synchronize Time** to synchronize the device time with the PC running the client after adding the device to the client.

7. **Optional:** Check **Import to Group** to create a group by the device name, and import all the channels of the device to this group.

**Example**

For encoding device, its encoding channels and alarm inputs/outputs will be imported to this group.

For access control device, its access points, alarm inputs/outputs, and encoding channels (if exist) will be imported to this group.

8. Click **Add**.

9. **Optional:** Click **Export Device**, select the saving path and device type, and click **OK** to export the device information to your PC.
- 

 **Note**

Currently, the platform only supports exporting the information of video intercom devices, including door stations, indoor stations, and main stations.

---

### 3.2.2 Add Device by IP Address or Domain Name

If you know the IP address or domain name of the device to add, you can add devices to the client by specifying the IP address (or domain name), user name, password, etc.

**Steps**

1. Enter Device Management module.

2. Click **Device** tab on the top of the right panel.

The added devices are displayed on the right panel.

3. Click **Add** to open the Add window, and then select **IP/Domain** as the adding mode.

## 4. Enter the required information.

### Name

Create a descriptive name for the device. For example, you can use a nickname that can show the location or feature of the device.

### Address

The IP address or domain name of the device.

### Port

The devices to add share the same port number. The default value is **8000**.

---



### Note

For some device types, you can enter **80** as the port No. This function should be supported by the device.

---

### User Name

Enter the device user name. By default, the user name is **admin**.

### Password

Enter the device password.

---



### Caution

The password strength of the device can be automatically checked. We highly recommend you change the password of your own choosing (using a minimum of 8 characters, including at least three kinds of following categories: upper case letters, lower case letters, numbers, and special characters) in order to increase the security of your product. And we recommend you change your password regularly, especially in the high security system, changing the password monthly or weekly can better protect your product.

Proper configuration of all passwords and other security settings is the responsibility of the installer and/or end-user.

---

## 5. **Optional:** Add the offline devices.

1) Check **Add Offline Device**.

2) Enter the required information, including the device channel number and alarm input number.

---



### Note

After adding the offline device to the client, the device network status will be displayed as "Offline"; When the device comes online, the device network status will turn to "Online", and the client will connect it automatically.

---

## 6. **Optional:** Check **Transmission Encryption (TLS)** to enable transmission encryption using TLS (Transport Layer Security) protocol for security purpose.

## Note

- This function should be supported by the device.
- If you have enabled Certificate Verification, you should click **Open Certificate Directory** to open the default folder, and copy the certificate file exported from the device to this default directory to strengthen the security. See ***Certificate Verification for Transmission Encryption*** for details about enabling certificate verification.
- You can log into the device to get the certificate file by web browser.







- 
7. Check **Synchronize Time** to synchronize the device time with the PC running the client after adding the device to the client.
  8. **Optional:** Check **Import to Group** to create a group by the device name, and import all the channels of the device to this group.

### Example

For encoding device, its encoding channels and alarm inputs/outputs will be imported to this group.

For access control device, its access points, alarm inputs/outputs, and encoding channels (if exist) will be imported to this group.

9. Finish adding the device.
  - Click **Add** to add the device and back to the device list page.
  - Click **Add and New** to save the settings and continue to add other device.
10. **Optional:** Perform the following operation(s).

<b>Remote Configuration</b>	On the device list page, click  in the Operation column to perform remote configuration for a device. The  is in the rightmost column of the Device page. For details, refer to the user manual of device.
<b>Device Status</b>	Click  in the Operation column to view device status, including cameras, recording status, signal status, hardware status, etc.
<b>Edit Device Information</b>	Click  in the Operation column to edit the device information, such as IP address, user name, and password.
<b>Check Online User</b>	Click  in the Operation column to check the online users who access the device, such as user name, user type, user's IP address, and login time.
<b>Refresh</b>	Click  in the Operation column to get the latest device information.
<b>Delete Device</b>	Select one or multiple devices and click <b>Delete</b> to delete the selected device(s) from the client.

## 3.2.3 Add Devices by IP Segment

If the devices share the same port No., user name and password, and their IP addresses ranges in the same IP segment, you can add them to the client by specifying the start IP address and the end IP address, port No., user name, password, etc of the devices.

### Steps

1. On the Maintenance and Management panel on the right side of the Client, Click **Device Management**.
2. Click **Device** tab on the top of the left panel.  
The added devices are displayed on the right panel.
3. Click **Add** to open the Add window.
4. Select **IP Segment** as the adding mode.
5. Enter the required information.

#### Start IP

Enter a start IP address.

#### End IP

Enter an end IP address in the same network segment with the start IP.

#### Port

Enter the device port No. The default value is **8000**.

---



#### Note

For some device types, you can enter **80** as the port No. This function should be supported by the device.

---

#### User Name

By default, the user name is **admin**.

#### Password

Enter the device password.

---



#### Caution

The password strength of the device can be automatically checked. We highly recommend you change the password of your own choosing (using a minimum of 8 characters, including at least three kinds of following categories: upper case letters, lower case letters, numbers, and special characters) in order to increase the security of your product. And we recommend you change your password regularly, especially in the high security system, changing the password monthly or weekly can better protect your product.

Proper configuration of all passwords and other security settings is the responsibility of the installer and/or end-user.

---

6. **Optional:** Add the offline devices.

- 1) Check **Add Offline Device**.

- 2) Enter the required information, including the device channel number and alarm input number.

---

 **Note**







After adding the offline device to the client, the device network status will be displayed as "Offline"; When the device comes online, the device network status will turn to "Online", and the client will connect it automatically.

- 
7. **Optional:** Check **Transmission Encryption (TLS)** to enable transmission encryption using TLS (Transport Layer Security) protocol for security purpose .

---

 **Note**

- This function should be supported by the device.
  - If you have enabled Certificate Verification, you should click **Open Certificate Folder** to open the default folder, and copy the certificate file exported from the device to this default directory to strengthen the security. See ***Certificate Verification for Transmission Encryption*** for details about enabling certificate verification.
  - You can log into the device to get the certificate file by web browser.
- 
8. Check **Synchronize Time** to synchronize the device time with the PC running the client after adding the device to the client.
  9. **Optional:** Check **Import to Group** to create a group by the device name, and import all the channels of the device to the group.
  10. Finish adding the device.
    - Click **Add** to add the device and back to the device list page.
    - Click **Add and New** to save the settings and continue to add other device.
  11. **Optional:** Perform the following operation(s).

<b>Remote Configuration</b>	On the device list page, click  in the Operation column to perform remote configuration for a device. The  is in the rightmost column of the Device page. For details, refer to the user manual of device.
<b>Device Status</b>	Click  in the Operation column to view device status, including cameras, recording status, signal status, hardware status, etc.
<b>Edit Device Information</b>	Click  in the Operation column to edit the device information, such as IP address, user name, and password.
<b>Check Online User</b>	Click  in the Operation column to check the online users who access the device, such as user name, user type, user's IP address, and login time.
<b>Refresh</b>	Click  in the Operation column to get the latest device information.
<b>Delete Device</b>	Select one or multiple devices and click <b>Delete</b> to delete the selected device(s) from the client.



## 3.2.4 Add Device by Hik-Connect

If the device supports Hik-Connect and its Hik-Connect function has been enabled, you can add it to both the client and Hik-Connect account by Hik-Connect mode; for devices already added to the Hik-Connect account, you can add them to the client after logging into the Hik-Connect account.

### Before You Start

Make sure you have registered and logged into a Hik-Connect account first.

### Steps

1. Enter Device Management module.

The added devices are displayed on the right panel.

2. Click **Device** tab on the top of the right panel.
3. Click **Add** to open the Add window.
4. Select **Hik-Connect** as the adding mode.
  - For the first time, you will be required to log into the Hik-Connect account.
  - The logged-in Hik-Connect account is displayed.
5. Select a region to login in the drop-down list of **Select the Region to Login** and then log into the Hik-Connect account, or enter the device serial number.
  - Enter the serial number which you can find on the device label.
  - If the IP address of the device is in the same local subnet with the client, click **Online Device** and select an online device to get its serial number automatically.
6. Enter the verification code of the device.





### Note

You can create the verification code when activating the device and enabling the Hik-Connect service, and is the same with the verification code created when enabling stream encryption. You can also create it on the device configuration page.

- 
7. **Optional:** Check **Import to Group** to create a group by the Hik-Connect account name, and import all the channels of the device to the group.
  8. Add device to the client software and Hik-Connect account.
    - Click **Add** to add the device and return to the device list.
    - Click **Add and New** to add the device and continue to add the next device.
  9. **Optional:** Perform the following operation(s).

### Remote Configuration

On the device list page, click  in the Operation column to perform remote configuration for a device. The  is in the rightmost column of the Device page. For details, refer to the user manual of device.

### Edit Device Information

Click  to edit the device details.

### Delete Device

Select one or multiple devices and click **Delete** to delete the selected device(s) from the client.

### 3.2.5 Add Device by ISUP Account

For access control devices supports ISUP 5.0 protocol, you can add them to the client by ISUP protocol after entering device ID and key, if you have configured their server addresses, port No., and device IDs.

#### Before You Start

Make sure the devices have connected to the network properly.

#### Steps

1. Enter Device Management module.  
The added devices are displayed on the right panel.
2. Click **Add** to open the Add window.
3. Select **ISUP** as the adding mode.
4. Enter the required information.

#### Device Account

Enter the account name registered on ISUP protocol.

#### ISUP Key





For ISUP 5.0 devices, enter the ISUP key if you have set it when configuring network center parameter for the device.



#### Note

This function should be supported by the device.

- 
5. **Optional:** Check **Synchronize Time** to synchronize the device time with the PC running the client after adding the device to the client.
  6. **Optional:** Check **Import to Group** to create a group by the device name, and import all the channels of the device to the group.
  7. Finish adding the device.
    - Click **Add** to add the device and go back to the device list.
    - Click **Add and New** to save the settings and continue to add other device.
  8. **Optional:** Perform the following operation(s).

<b>Device Status</b>	Click  on Operation column to view device status.
<b>Edit Device Information</b>	Click  on Operation column to edit the device information, such as device name, device account, and ISUP key.
<b>Check Online User</b>	Click  on Operation column to check the online users who access the device, such as user name, user type, user's IP address, and login time.
<b>Refresh</b>	Click  on Operation column to get the latest device information.
<b>Delete Device</b>	Select one or multiple devices and click <b>Delete</b> to delete the selected device(s) from the client.

## 3.2.6 Import Devices in a Batch

You can add multiple devices to the client in a batch by entering the device parameters in a pre-defined CSV file.

### Steps

1. Enter the Device Management module.
2. Click **Device** tab on the top of the right panel.
3. Click **Add** to open the Add window, and then select **Batch Import** as the adding mode.
4. Click **Export Template** and then save the pre-defined template (CSV file) on your PC.
5. Open the exported template file and enter the required information of the devices to be added on the corresponding column.



For detailed description of the required fields, refer to the introductions in the template.

---

### Adding Mode

Enter **0** or **1** or **2**.

### Address

Edit the address of the device.

### Port

Enter the device port number. The default port number is **8000**.

### User Name

Enter the device user name. By default, the user name is **admin**.

### Password

Enter the device password.

---



### Caution

The password strength of the device can be automatically checked. We highly recommend you change the password of your own choosing (using a minimum of 8 characters, including at least three kinds of following categories: upper case letters, lower case letters, numbers, and special characters) in order to increase the security of your product. And we recommend you change your password regularly, especially in the high security system, changing the password monthly or weekly can better protect your product.

Proper configuration of all passwords and other security settings is the responsibility of the installer and/or end-user.

---

### Add Offline Device

Enter **1** to enable adding an offline device.

After adding the offline device to the client, the device network status will be displayed as "Offline"; When the device comes online, the device network status will turn to "Online", and the client will connect it automatically. Enter **0** to disable adding an offline device.

### Import to Group

Enter **1** to create a group by the device name. All the channels of the device will be imported to the corresponding group by default. Enter **0** to disable this function.

### Channel Number

If you enable **Add Offline Device**, enter the channel number of the device. If you disable **Add Offline Device**, this field is not required.







### Alarm Input Number

If you enable **Add Offline Device**, enter the alarm input number of the device. If you disable **Add Offline Device**, this field is not required.

6. Click  and select the template file.

7. Click **Add** to import the devices.

8. **Optional:** Perform the following operation(s).

<b>Remote Configuration</b>	On the device list page, click  in the Operation column to perform remote configuration for a device. The  is in the rightmost column of the Device page. For details, refer to the user manual of device.
<b>Device Status</b>	Click  in the Operation column to view device status, including cameras, recording status, signal status, hardware status, etc.
<b>Edit Device Information</b>	Click  in the Operation column to edit the device information, such as IP address, user name, and password.
<b>Check Online User</b>	Click  in the Operation column to check the online users who access the device, such as user name, user type, user's IP address, and login time.
<b>Refresh</b>	Click  in the Operation column to get the latest device information.
<b>Delete Device</b>	Select one or multiple devices and click <b>Delete</b> to delete the selected device(s) from the client.

## 3.3 Restore/Reset Device Password

If you forgot the password of the detected online devices, you can restore the device's default password or reset the device's password through the client.

### 3.3.1 Reset Device Password

If you forgot the password of the detected online devices, you can reset the device password via the client.

## Steps

1. Enter Device Management page.
2. Click **Device** tab on the top of the right panel.
3. Click **Online Device** to show the online device area.

All the online devices sharing the same subnet will be displayed in the list.

4. Select the device from the list and click  on the Operation column.
5. Reset the device password.
  - Click **Export** to save the device file on your PC and then send the file to our technical support.

---

### Note

For the following operations for resetting the password, contact our technical support.

- Click **Generate** to pop up the QR Code window and click **Download** to save the QR code to your PC. You can also take a photo of the QR code to save it to your phone. Send the picture to our technical support.

---

### Note

For the following operations for resetting the password, contact our technical support.

- Select the Safe Mode according to actual needs.

---

### Note

For the following operations for resetting the password, contact our technical support.

---

### Caution

The password strength of the device can be automatically checked. We highly recommend you change the password of your own choosing (using a minimum of 8 characters, including at least three kinds of following categories: upper case letters, lower case letters, numbers, and special characters) in order to increase the security of your product. And we recommend you change your password regularly, especially in the high security system, changing the password monthly or weekly can better protect your product.

Proper configuration of all passwords and other security settings is the responsibility of the installer and/or end-user.

---

## 3.3.2 Restore Device's Default Password

If you forget the password of the detected online devices, you can restore their default password via the client.

### Steps

1. Enter Device Management page.
2. Click **Device** tab on the top of the right panel.
3. Click **Online Device** to show the online device area at the bottom of the page.

All the online devices sharing the same subnet will be displayed in the list.

4. Select a device and click  on the Operation column to open the Reset Password window.
5. Restore the device password.
  - Enter the security code, and then you can restore the default password of the selected device.

---

 **Note**

For getting the security code, contact our technical support.

- Click **Export** to save the device file on your PC and send the file to our technical support.

---

 **Note**

For the following operations for resetting the password, contact our technical support.

---

### What to do next

The default password (12345) for the admin account is for first-time login purposes only. You must change this default password to better protect against security risks, such as the unauthorized access by others to the product that may prevent the product from functioning properly and/or lead to other undesirable consequences.



### Caution

The password strength of the device can be automatically checked. We highly recommend you change the password of your own choosing (using a minimum of 8 characters, including at least three kinds of following categories: upper case letters, lower case letters, numbers, and special characters) in order to increase the security of your product. And we recommend you change your password regularly, especially in the high security system, changing the password monthly or weekly can better protect your product.

Proper configuration of all passwords and other security settings is the responsibility of the installer and/or end-user.

---

## 3.4 Upgrade Device Firmware Version

When there is a new firmware version available for the added device, you can upgrade its firmware version via the client.



### Note

- The device should support this function.
- You can configure upgrading mode in System Configuration. See ***Set General Parameters*** for details.

---

Enter the Device Management module, and then click **Device** tab to show the device list.

Perform the following operations according to different upgrading modes.

## Disable

On the Device for Management panel, if there is a new firmware version available, the status in the Firmware Upgrade column of the device will turn to **Upgradeable**.

Select the upgradeable device and click **Upgrade** to start upgrading the device firmware.

---

### Note

The upgrade progress will show. When the upgrade is completed, the status in the Firmware Upgrade column of the device will turn to **Upgraded**.

---

## Prompt Me If Download and Upgrade

If there is a new firmware version available, a prompt window will pop up. Click **Upgrade All** to start downloading and upgrading.

## Download and Prompt Me If Upgrade

A dialog will pop up for selecting whether to upgrade after downloading package of new version. Click **Upgrade All** to start upgrading the device firmware.

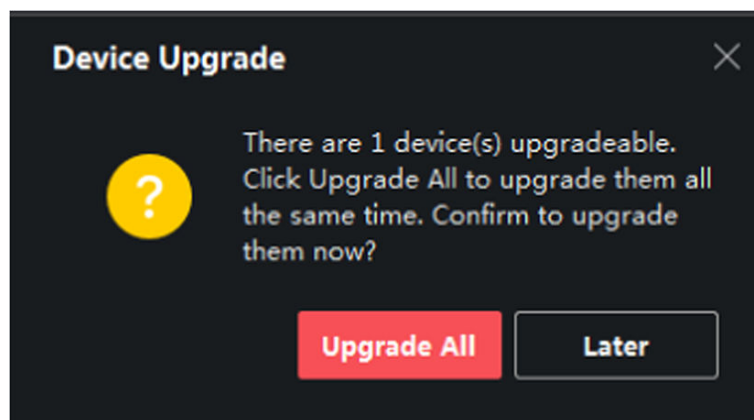

Figure 3-5 Device Upgrade Prompt

### Note

After clicking **Upgrade All**, a prompt will pop up for viewing details. If you are not in Device Management page, click **View Details** to jump to Device Management page; if you are in Device Management page, close the prompt.

---

## Upgrade Status

On the device management page, the following upgrade status will be shown in the Firmware Upgrade column.

### No Available Version

No new firmware version available.

---

## Upgradeable

A new firmware version available.

---

### Note

Move the cursor on  to view the current version, latest version, and upgrade content of the firmware version.

---

## Waiting

The device is waiting for upgrade.

## Downloading

The client is downloading the package of the new firmware version.

## Upgrading

The upgrading of the device firmware is going on.

## Upgraded

Hover the cursor on **Upgraded** to show the version after upgrading.

## Upgrading Failed

When the upgrade fails, a prompt will pop up for viewing details. If you are not in Device Management page, click **View Details** to jump to Device Management page; if you are in Device Management page, close the prompt. Hover the cursor on **Upgrading Failed** to show the error details, and click **Upgrade Again** to try again.

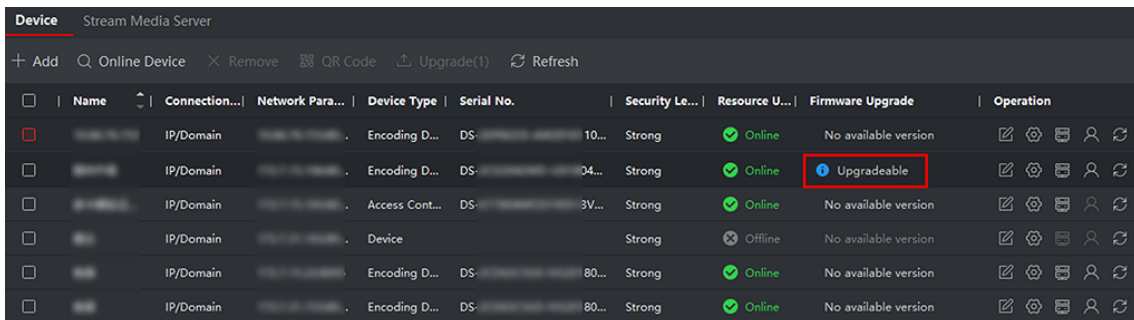

Device	Stream Media Server							
Name	Connection...	Network Para...	Device Type	Serial No.	Security Le...	Resource U...	Firmware Upgrade	Operation
	IP/Domain		Encoding D...	DS-	10...	Strong	Online	No available version
	IP/Domain		Encoding D...	DS-	04...	Strong	Online	<b>Upgradeable</b>
	IP/Domain		Access Cont...	DS-	3V...	Strong	Online	No available version
	IP/Domain		Device			Strong	Offline	No available version
	IP/Domain		Encoding D...	DS-	80...	Strong	Online	No available version
	IP/Domain		Encoding D...	DS-	80...	Strong	Online	No available version









Figure 3-6 Firmware Upgrade

## 3.5 Manage Added Devices

After adding devices to device list, you can manage the added devices including editing device parameters, remote configuration, viewing device status, etc.



**Table 3-1 Manage Added Devices**

Edit Device	Click  to edit device information including device name, address, user name, password, etc.
Delete Device	Check one or more devices, and click <b>Delete</b> to delete the selected devices.
Remote Configuration	On the device list page, click  in the Operation column to perform remote configuration for a device. The  is in the rightmost column of the Device page. For details, refer to the user manual of device.
View Device Status	Click  to view device status, including cameras, recording status, signal status, hardware status, etc.   <b>Note</b> For different devices, you will view different information about device status.
View Online User	Click  to view the details of online user who access the device, including user name, user type, IP address and login time.
Refresh Device Information	Click  to refresh and get the latest device information.
Generate QR Code	Check one or more devices, and click <b>QR Code</b> to generate a QR code of the added device(s). You can add device(s) to the Mobile Client via scanning the QR code.   <b>Note</b> Devices added by ISUP or Hik-Connect cannot generate a QR code.
Upgrade Device	View device status in the Firmware Upgrade column, check one or more upgradable devices, and click <b>Upgrade Device Firmware</b> to upgrade the selected devices. For details, refer to <a href="#"><b><i>Upgrade Device Firmware Version</i></b></a> .
Get Events from Device	Check one device, and click <b>Get Events from Device</b> to synchronize events. For details, refer to <a href="#"><b><i>Get Events from Device</i></b></a> .

### 3.6 Group Management

The client provides groups to manage the added resources in different groups. You can group the resources into different groups according to the resources' locations.

## Example

For example, on the 1st floor, there mounted 64 cameras, 16 doors, 64 alarm inputs, and 16 alarm outputs. You can organize these resources into one group (named 1st Floor) for convenient management. You can get the live view, play back the video files, control door status, and do some other operations of the devices after managing the resources by groups.

## 3.6.1 Group Resources

The client provides two methods of adding a group: customizing a group or creating a group by device name. After customizing a group, you need to import resources into this group manually. After creating a group by the device name, the resources of the device will be imported into the group automatically. You can choose one method to group your resources according to actual needs.

### Steps

1. In the Maintenance and Management area, click **Device Management** → **Group** to enter the group management page.
2. Add a group.
  - **Customize a Group:** Click **Add Group** and create a name for the new group.
  - **Create a Group by Device Name:** Click **Create Group by Device Name** and select an added device to create a new group by the name of the selected device. After creating a group by the device name, the resources (such as encoding channels, alarm inputs, alarm outputs, and access points) of the device will be automatically imported to the group.

---

### Note

- Up to 256 groups can be added.
- You can select multiple groups by pressing and holding Shift or Ctrl key on the keyboard.



3. After adding a group, you need to import resources into the group.

---

### Note

For one resource, it can be added to different groups.

- 1) Select the type of resources to be imported, and click **Import**.
  - 2) Select the resources to be imported, and click **Import** to import all the selected resources into this group.
4. **Optional:** After adding a group, perform one of the following operations if needed.

**Expand or Fold Resource List**      Click  /  to expand or fold the resource list in the group.

**Search Resource**      Enter the keyword and click  to search target resources.

**Remove Resource from Group**      Select resource(s) and click **Delete** to remove the selected resource(s) from the group.

## **Update Resource Name**

You can update all the resource names in a group or in a channel.

- Select a group, and click **Update Resource Name** to update all the resource names in the selected group.
- Select a channel in one group, and update all the resource names in this channel. For example, click **Encoding Channels → Update Camera Name** to update all the camera names in encoding channels.



This function should be supported by the device.

---

## **3.6.2 Edit Resource Parameters**

After importing the resources to the group, you can edit the resource parameters. For encoding channel, you can edit the channel name, stream type, protocol type, etc. For access point, you can edit the access point name. For alarm input, you can edit the alarm input name. Here we take encoding channel as an example.

### **Before You Start**

Import the resources to group.

### **Steps**

1. Enter the Device Management module.
2. Click **Device Management → Group** to enter the group management page.  
All the added groups are displayed on the left.
3. Select a group on the group list and click **Encoding Channel**.  
The encoding channels imported to the group will display.
4. Click  in the Operation column to open the Edit Resource window.
5. Edit the camera information, including the camera name, the stream type, etc.

### **Video Stream**

Select the stream type for live view of the camera as desired.



You should start live view again to take effect.

---

### **Playback Stream Type**

Select the stream type for playback of the camera as desired.



- This field will display if the device supports dual-stream.
  - You should start live view again to take effect.
- 

### **Rotation Type**

Select the rotate type for the live view or playback of the camera as desired.

### **Protocol Type**

Select the transmission protocol for the camera.

---

#### **Note**

You should start live view again to take effect.

---

### **Streaming Protocol**

Select the protocol as RTSP or private for getting stream when live view.

---

#### **Note**

You should start live view again to take effect.

---

### **Copy to...**

Copy the configured parameters to other camera(s).

### **Refresh**

Get a new captured picture for the live view of the camera.

6. Click **OK** to save the new settings.

## Chapter 4 Hik-Connect

The client software also supports to register a Hik-Connect account, log into your Hik-Connect account and manage the devices which support the Hik-Connect service.

### 4.1 Register a Hik-Connect Account

The client supports registering a Hik-Connect account to manage devices which supports Hik-Connect service.

#### Steps

1. Enter the login page of Hik-Connect.
  - Click **Log in** in the upper-right corner of the client.
  - a. Click **Device Management** → **Device** to enter the Device Management page.
  - b. Click **Add** to open the Add Device panel.
  - c. Select **Hik-Connect** as the adding mode.
  - d. Click **Login**.

The Login window pops up.

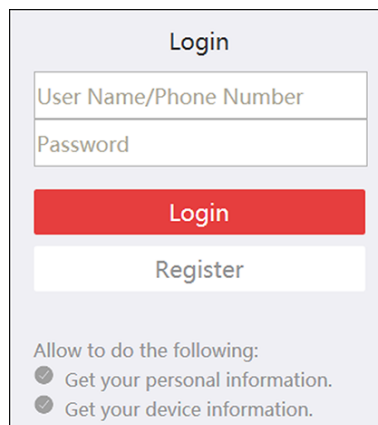

**Figure 4-1 Login Window**

2. Click **Register** to open the Register Account window.
3. Enter the required information, including user name, password, confirm password, and phone number/email address.

---

#### **Caution**

The password strength of the device can be automatically checked. We highly recommend you change the password of your own choosing (using a minimum of 8 characters, including at least three kinds of following categories: upper case letters, lower case letters, numbers, and special characters) in order to increase the security of your product. And we recommend you change

your password regularly, especially in the high security system, changing the password monthly or weekly can better protect your product.

Proper configuration of all passwords and other security settings is the responsibility of the installer and/or end-user.

---

4. Click **Send Message** to get a verification code.

The system will send verification code to your phone or email.

5. Enter the received verification code in the **Verification Code** text field.
6. Check **I have read and agreed Terms of Service Privacy Policy**.
7. Click **Register** to finish the registration.

## 4.2 Log into Hik-Connect Account

You can log into Hik-Connect account via the client, so as to operate devices managed by Hik-Connect account.

### Before You Start

Register a Hik-Connect account.

---



For details, refer to [\*Register a Hik-Connect Account\*](#) .

---

### Steps

1. Enter the login page of Hik-Connect.
  - Click **Log in** in the upper-right corner of the client.
  - a. Click **Device Management** → **Device** to enter the Device Management page.
  - b. Click **Add** to open the Add Device panel.
  - c. Select **Hik-Connect** as the adding mode.
  - d. Click **Login**.

The Login window pops up.

2. Enter user name/phone number, and password.
3. Click **Log in** to log into your account.

**Log in** will turn to **Logged in**.

4. **Optional:** Click **Logged in** → **Log out** to log out of your account.
- 



- Devices added by Hik-Connect will be hidden after logging out the Hik-Connect.
  - Alarm-related pictures saved in Hik-Connect will be valid for 2 hours.
-













## Chapter 5 Live View

For the surveillance task, you can view the live video of the added network cameras and video encoders on the Main View page. And some basic operations are supported, including picture capturing, manual recording, window division, PTZ control, Auto-Switch in live view, etc.



### 5.1 Live View Toolbar

The live-view toolbar can help you operate and manage the live-view window more convenient and quick. For example, you can capture picture, record the audio, adjust the volume, split the window by the one-click of the tools on the toolbar.

**Table 5-1 Descriptions of Toolbar**

Icon	Function Name	Function Description and Operation
	Save View	Save the view you create currently, which is convenient for quick viewing the required cameras. Click  to pop up the window of saving view. Select <b>Create View</b> or <b>Current View</b> , and name for the view.
	Stop Live View	Stop the all the live view cameras.
	Mute/Cancel Mute	Click  to pop up the volume bar, click  to cancel the mute and you can adjust the volume. Click  to pop up the volume bar, click  again to set the live-view cameras as mute.
	Window Division	Select the different window division mode for live view. Click  to select one window division mode (e.g. 9 window division). You can also click <b>Add</b> to customize a window division mode.
	Full Screen	Display the live view in full screen. Press <b>Esc</b> key to exit full screen mode.
	Configuration	Enter the live view parameters setting mode, configure for live view and playback, image, files and toolbar.

**Table 5-2 Description of Icons on Live View Window**

Icon	Function Name	Function Description and Operation
	Capture	Manually capture the pictures for the live view window.
	Start Recording/ Stop Recording	Click the first time to start recording and click again to stop recording, and automatically save the recording files to the path you have set.
	Switch to Instant Playback	On the current time, you can select to play back the video in previous 30 s, 1 min, 3 min, 5 min, 8 min, 10 min.

## 5.2 Add Custom View



A view is a window division with cameras configured to each window; View mode enables you to save the window division and the correspondence between cameras and windows as favorite to quickly access the related cameras later. For example, you can link camera 1, camera 2, and camera 3 located in your office to display windows and save them as a view called office.

### Steps

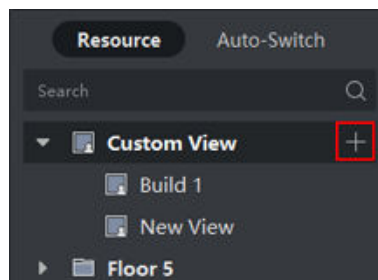
1. Enter the Main View page.
2. Click **Resource** tab.
3. Move the cursor to the Custom View in the resource panel and click  to create a new view.



**Figure 5-1 Add Custom View**

4. Enter a name for the view.
5. **Optional:** Click  in the live view toolbar to set window division mode for the new view.
6. Start live view for specified camera in specified window according to actual needs.
7. Click  to save the current view or save it as a new view.

### Note

Up to 16 custom views are allowed to add to the client.

8. **Optional:** Perform the following operations after adding the custom view.

**Edit View Name** Move the cursor over the new view and click  to edit the view name.



**Delete View**      Move the cursor over the new view and click  to delete the view.





**What to do next**

Click  again to select the custom window division.

### 5.3 Start Live View

You can start live view after adding device(s) to the client so that you can get to know the monitored area well. You can start the live view of one camera or all cameras in a group. You can also start the live view in custom view mode.

Click **Main View** → **Resource** to enter Main View page. On the left resource list, select resource(s) and start live view by the following ways.

Available Ways	Description	Operation
Start Live View for One Camera	Start the live view of only one camera in a group.	<ul style="list-style-type: none"> <li>• Select a camera and drag it to the window.</li> <li>• Double-click the camera in a group.</li> <li>• Move your cursor over the camera name, and click .</li> </ul>
Start Live View for Camera Group	Start the live view of all cameras in one group synchronously.	<ul style="list-style-type: none"> <li>• Select a group and drag it to the window.</li> <li>• Double-click the group.</li> <li>• Move your cursor over the group name, and click , or click  → <b>View All Cameras in Group</b>.</li> </ul>
Start Live View in Custom View Mode	Start the live view of the cameras in the custom view.	<ul style="list-style-type: none"> <li>• Select a custom view and drag it to the window.</li> <li>• Double-click the custom view.</li> </ul> <p> <b>Note</b>                      Customize a view which containing information such as window division, camera and correspondence between cameras and windows. See <b><i>Add Custom View</i></b> for details.</p>

 **Note**

If the device supports stream encryption, and the stream of its live view is encrypted, you are required to enter a stream key for double verification.

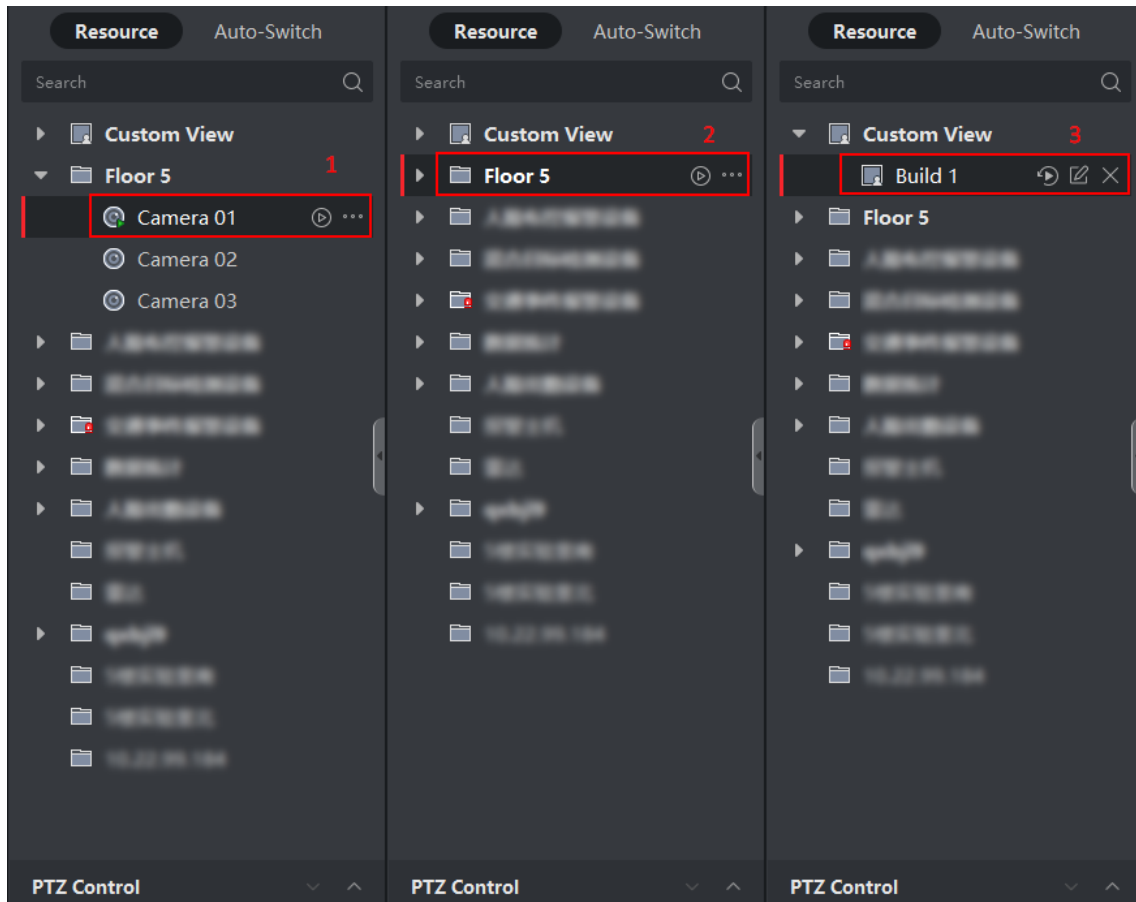

Figure 5-2 Start Live View

During live view, you can view the bitrate, frame rate and resolution information on the image.

## 5.4 Auto-Switch in Live View

You can display live view of cameras or display the custom views in turn, which is called "auto-switch". If you want to perform live view of a large amount of cameras, you can auto-switch the selected cameras, which means the client will automatically switch live view of the cameras in the display window. You can also auto-switch multiple views.

When auto-switching in live view, three modes are available:

- Auto-Switch All Cameras in Default View
- Auto-Switch Cameras in a Group
- Auto-Switch Custom Views

### 5.4.1 Auto-Switch Cameras in a Group

The video stream of the cameras from the same group can switch automatically in a selected display window. For example, if you start auto-switch of a group containing 5 cameras, the live view of the 5 cameras will be displayed in turn with an interval which can be configured. You can also switch to playback and perform other operations on the display window.

#### Steps

1. Enter the Main View page.
2. Click **Auto-Switch** → **Single Window Auto-Switch** on the left panel to show the groups.
3. Select a display window on the right panel.
4. Hover the cursor on a group name and click  .

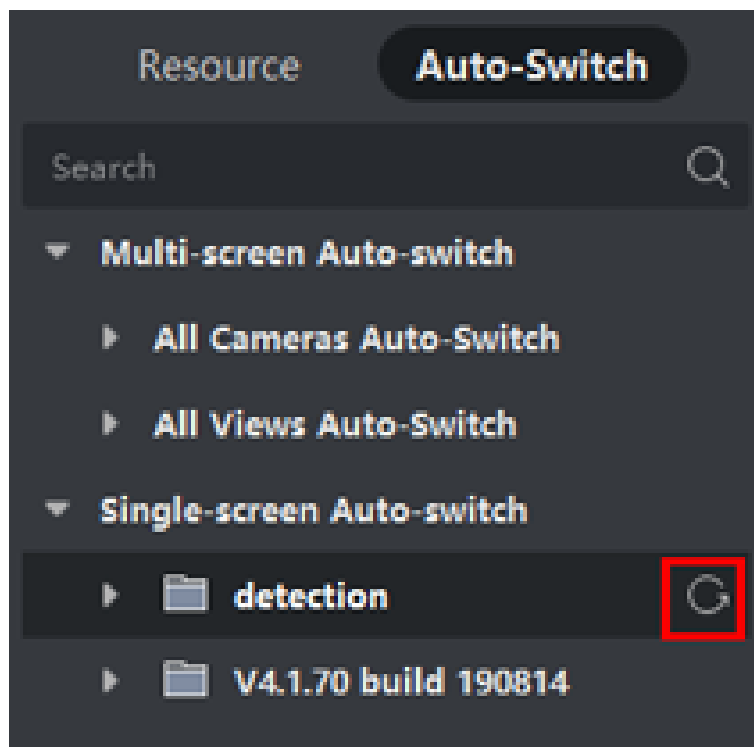

Figure 5-3 Start Auto-Switch of Cameras in a Group

The cameras in the selected group starts auto-switch in the display window.



---

#### Note



The audio is off by default after auto-switch starts.

---



#### 5. Optional: Perform the following operations.

Operation	Description
Pause/Resume Auto-Switch	Click  or  to pause/resume auto-switch.

**Go to Previous/  
Next Page**

Click  or  to display cameras of the previous/next group.

**Set Dwell Time**

After stopping the current auto-switch, click  or  to decrease/increase auto-switch dwell time, or click **20s** at the bottom of the page to change the auto-switch dwell time. You can also click **Custom Dwell Time** to set the dwell time according to your need. For example, if you set the interval as 10 seconds, the image of each group will be displayed for 10 seconds and then switch to next group.

## 5.4.2 Auto-Switch All Cameras

The video of all the cameras in the camera list can switch automatically in a self-adaptive mode. If you start auto-switch of all cameras, the live view of all cameras can be displayed quickly, which is an effective way for live view. The auto-switch is performed with an interval which can be configured. You can also switch to playback and perform other operations on the auto-switch window.

**Steps**

1. Enter the Main View page.
2. Click **Auto-Switch** → **Multi-Window Auto-Switch** on the left panel.
3. Hover the cursor on **Auto-Switch All Cameras**, and then click .

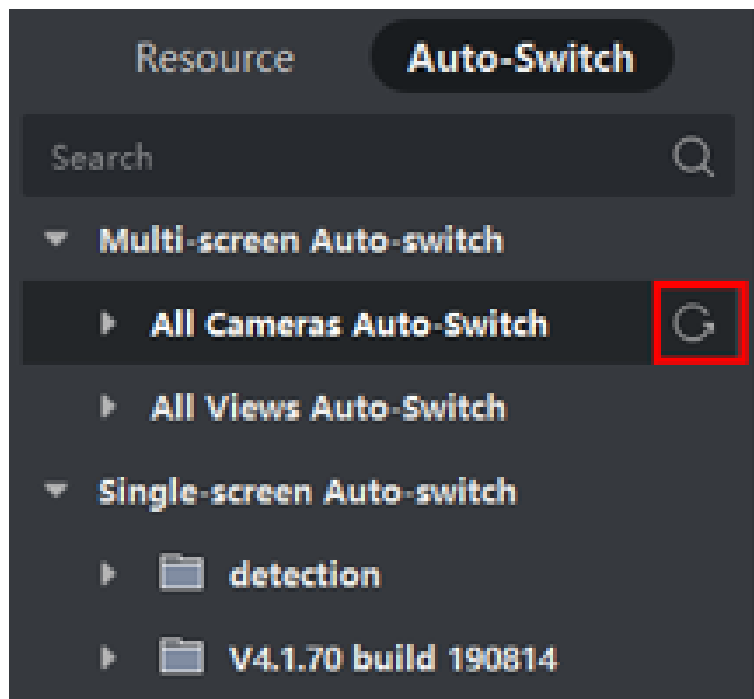







Figure 5-4 Start Auto-Switch of All Cameras

All cameras in the camera list start auto-switching in a self-adaptive mode.

**4. Optional:** Perform the following operations.

Operation	Description
<b>Pause/Resume Auto-Switch</b>	Click  or  to pause/resume auto-switch.
<b>Go to Previous/Next Page</b>	Click  or  to display cameras on the previous/next page.
<b>Set Dwell Time</b>	After stopping the current auto-switch, click  or  to decrease/increase auto-switch dwell time, or click <b>20s</b> at the bottom of the page to change the auto-switch dwell time. You can also click <b>Custom Dwell Time</b> to set the dwell time according to your need. For example, if you set the interval as 10 seconds, the image of each camera will be displayed for 10 seconds and then switch to next camera.

### 5.4.3 Auto-Switch Custom Views

A view is a window division with resource channels (e.g., cameras) linked to each window. View mode enables you to save the window division and the correspondence between cameras and windows as favorite so that you can quickly access these channels later. If you save a view containing all cameras on a floor, you save a custom view, and you can view the live view of all the cameras on the floor in turn by a one-click operation. In this way, you do not have to search these cameras in the camera list every time you login. The auto-switch performs with an interval which can be configured manually.

#### Before You Start

Add the custom views. See [\*\*\*Add Custom View\*\*\*](#) for details.

#### Steps

1. Enter the Main View page.
2. Click **Resource** → **Multi-Window Auto-Switch** on the left panel.
3. Hover the cursor on **Auto-Switch All Views** and click .

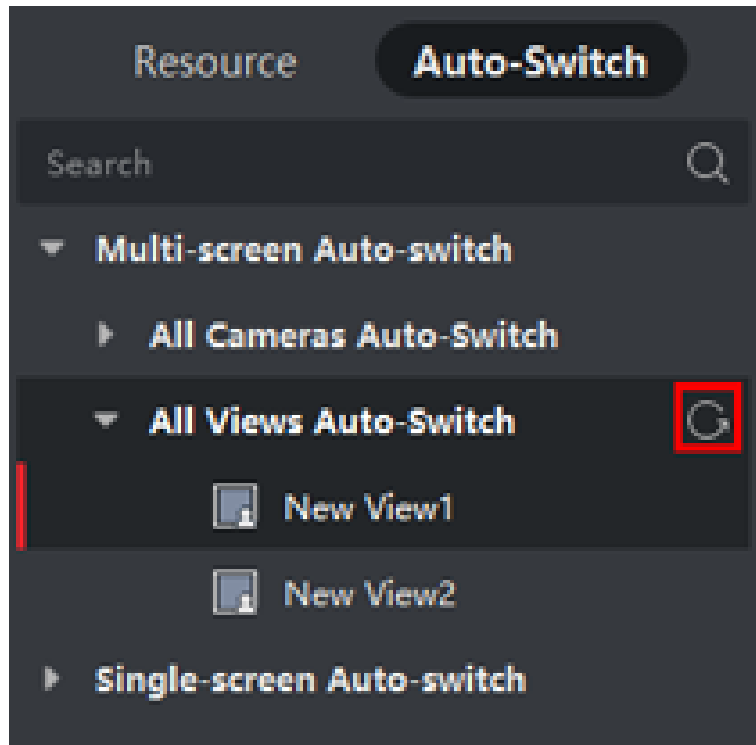

Figure 5-5 Auto-Switch a Custom View

All custom views starts auto-switching.

4. **Optional:** Perform the following operations.

Operation	Description
<b>Pause/Resume Auto-Switch</b>	Click  or  to pause/resume auto-switch.
<b>Go to Previous/Next Page</b>	Click  or  to display the previous/next view.
<b>Set Dwell Time</b>	After stopping the current auto-switch, click  or  to decrease/increase auto-switch dwell time, or click <b>20s</b> at the bottom of the page to change the auto-switch dwell time. You can also click <b>Custom Dwell Time</b> to set the dwell time according to your need. For example, if you set the interval as 10 seconds, the image of each view will be displayed for 10 seconds and then switch to next view.

## 5.5 Object Missing

This object is not available in the repository.

### 5.5.1 PTZ Control Panel

The software provides PTZ control operations via control panel, such as detection, speed, zoom in, zoom out, etc. You can also open a new window for controlling the PTZ.









 **Note**











Hik-Connect device only supports the PTZ movements to the directions of up, down, left, and right.

Enter the **Main View** module, and select **PTZ Control** to open the PTZ control panel.







The following icons are available on the PTZ control panel.

**Table 5-3 Icons on PTZ Control Panel**

Icon	Name	Description
	Direction Buttons	Click or hold the left mouse button to turn the PTZ around. Click  to turn around the PTZ horizontally and continuously; click again to stop turning.
	Speed Control	Drag the slider to adjust the PTZ moving speed.
	Zoom in/out	Zoom in to view close image for details; zoom out to view a panoramic image.
	Focus +/-	Click <b>Focus +</b> move the focal point forward, and click <b>Focus -</b> to move the focal point backward.
	Iris +/-	Used for adjusting the luminance of the image. The larger the iris is, the more the light enters, and the brighter the image will be.
	3D Positioning	Use the left key of mouse to click on the desired position in the video image and drag a rectangle area in the lower right direction, then the dome system will move the position to the center and allow the rectangle area to zoom in. Use the left key of mouse to drag a rectangle area in the upper left direction to move the position to the center and allow the rectangle area to zoom out.
	Auxiliary Focus	Click to focus automatically.

Icon	Name	Description
	Lens Initialization	Initialize the lens and focus again for a clear image.
	Light	Click to fill light.  <b>Note</b> This function needs to be supported by the device.
	Wiper	Use the wiper to clear the dust on the camera lens.
	Manual Tracking	For speed dome with auto-tracking function, enable the auto-tracking (via right-click menu) for it and click the icon to manually track the target by clicking on the video.
	Menu	For analog speed dome, click the icon to display its local menu. For detailed operation of the menu, refer to user manual of the speed dome.
	One-Touch Patrol	For speed dome with one-touch patrol function, click the icon and the speed dome starts patrol from the predefined preset No.1 to preset No.32 in order after a period of inactivity (park time). For setting the park time, refer to user manual of the speed dome.
	One-Touch Park	For the speed dome with one-touch park function, click the icon and the speed dome saves the current view to the preset No.32. The device starts to park at preset No. 32 automatically after a period of inactivity (park time). For setting the park time, refer to user manual of the speed dome.
	Enable Manual Lens De-Icing Heater	Enable this function to ensure the camera performance by heating.  <b>Note</b> We suggest you enable this function when the environment temperature is under 0 °C,









Icon	Name	Description
		otherwise the high temperature may affect the camera work.
	Enable Manual PT De-Icing	Enable this function to ensure the camera performance by wiping off the ice adhered on the PTZ camera.
	Manual Face Capture	Click this button, and hold the left mouse button to select a face in the image to capture it. The picture will be uploaded to the server for viewing.
	Synchronize FOV	For thermal cameras, click the icon to synchronize the optical channel's field of view with that of the thermal channel.
	Regional Exposure	For speed domes, click the icon and draw a rectangle on the image to optimize the exposure effect in this region.
	Regional Focus	For speed domes, click the icon and draw a rectangle on the image to optimize the focus effect in this region.
	Arming and Tracking	For cameras support arming and tracking, click the icon and select the target (person or vehicle) in the live view to arm and track this target.

### 5.5.2 Set Preset, Patrol, and Pattern

PTZ control supports setting and calling a preset, patrol, and pattern.

On the Home Page, click **Main View → PTZ Control** to show the PTZ Control panel.

Task	Definition	Operation
Preset	A preset links the key regions to mobile PTZ position and status. Monitoring people uses it to positioning to key regions rapidly. By sending setting preset command, mobile PTZ	How to Set: select a preset from the preset list→turn the camera to a desired position→click  。
		How to Call: click  。

Task	Definition	Operation
	records the position and status of zoom, focus, and iris. When executing calling preset command, mobile PTZ rapidly rolls to the set position and resume to set status.	
Pattern	By recording pattern, the movement path and the dwell time in a certain position can be recorded precisely. By calling pattern, mobile PTZ starts move totally according to the recorded path.	How to Set: click  to start recording a pattern→click the direction buttons to shape the pattern→click  .
		How to Call: click  .
Patrol	Patrol is the function that users specify a scan track with a group of defined presets. The patrol between two presets is performed with the set speed and time.	How to Set: click  →select presets, and set speed and time→click <b>OK</b> .
		How to Call: click  .

 **Note**

You should set at least two presets beforehand.

## 5.6 Customize Window Division

The client software provides multiple kinds of predefined window divisions. You can also set custom the window division as desired.

### Steps

 **Note**

Up to 5 window divisions can be customized.

1. Open the Main View or Remote Playback page.
2. Click  on the live view or playback toolbar to open the window division panel.
3. Click **Add** to open the Add Custom Window Division dialog.
4. Enter the window numbers in both horizontal and vertical dimension in the Dimension field, and then press **Enter** on your keyboard.

---

## Note

For remote playback, up to 16 windows can be played at the same time, so the custom window division with more than 16 windows is invalid.

---

5. **Optional:** Drag your mouse to select the adjacent windows, and click **Joint** to joint them as a whole window.
6. **Optional:** Select the joint window and click **Restore** to cancel the joint.
7. Click **Save**.
8. **Optional:** Click or drag a division mode to the displaying window to apply the mode for displaying.
9. **Optional:** Edit a customized window division mode.
  - 1) Click  on the live view or playback toolbar to open the window division panel.
  - 2) Click **Edit** to open the Add Custom Window Division.
  - 3) Select a customized division mode and perform operations including renaming, setting dimension, jointing/undo jointing windows.

## 5.7 Manually Record and Capture

During live view, you can record videos and capture pictures manually, and then view the recorded video files and captured pictures in the local PC.

### 5.7.1 Manually Record Video

Manual recording function allows to record the live video on the Main View page manually, and you can store the video files in the local PC.

#### Steps

---

## Note

Manual recording is not supported by Hik-Connect device during live view.

---

1. Open the Main View page.
2. Start the live view.
3. Perform one of the following operations to start manual recording.
  - Move the cursor to the display window in live view to show the toolbar and click  on the toolbar.
  - Right-click on the display window and click **Start Recording** on the right-click menu.

The icon  turns to . An indicator   appears in the upper-right corner of the display window.

4. Click  to stop the manual recording.

The recorded video file is automatically saved to the local PC, and a small window with the saving path information appears in the lower-right corner of desktop.

---

## Note

The saving path of the recorded video files can be set on the System Configuration page. See [Set File Saving Path](#) for details.

---

## 5.7.2 View Local Videos

You can view the recorded video files stored in your local PC.

### Before You Start

Record the live video.

### Steps

1. Click  → **File** → **Open Video File** in the upper-right corner to open the Video Files page.
2. Select the camera to search the recorded video files from the Camera Group list.
3. Specify the start time and end time in the lower-left corner for the searching.
4. Click **Search**.

The video files recorded between the start time and end time displays in thumbnail format on the page.

5. **Optional:** Perform the following operation(s) after the search.

- |                          |  |
|--------------------------|--|
| <b>Delete Video File</b> | Select the video file, and click <b>Delete</b> to delete the video file.   |
| <b>Send Email</b>        | Select the video file, and click <b>Email</b> to send an email notification with the selected video file attached. |

---

## Note

To send an email notification, the email settings need to be configured before proceeding. For details, refer to [Set Email Parameters](#) .

---

- |                         |   |
|-------------------------|---|
| <b>Save Local Video</b> | Select the video file, and click <b>Save as</b> to save a new copy of the video file. |
| <b>Playback</b>         | Double-click the video file to start the local playback.                              |

## 5.7.3 Capture Pictures

You can capture pictures during the live view.

Perform this task when you need to capture pictures during the live view.

### Steps

1. Open Main View page and start the live view of a camera.
2. Perform one of the following operations to capture pictures.

- Move the cursor to the display window in live view to show the toolbar and click  on the toolbar.
- Right-click the display window and click **Capture** on the right-click menu.

The captured picture is automatically saved to the local PC, and a small window with the picture preview and saving path information appears in the lower-right corner of desktop.



### Note

The saving path of the captured pictures can be set on the System Configuration page. For details, refer to [\*\*\*Set File Saving Path\*\*\*](#).

---

## 5.7.4 View Captured Pictures

The pictures captured in the live view are stored in the PC running the software. You can view the captured pictures if needed.

### Before You Start

Capture pictures in the live view.

### Steps

1. Click  → **File** → **Open Captured Picture** in the upper-right corner to open the Captured Picture page.
2. Select the camera to search the captured pictures from the Camera Group list.
3. Specify the start time and end time in the lower-left corner for the searching.
4. Click **Search**.

The pictures captured between the start time and end time display in thumbnail format on the page.

5. **Optional:** Perform the following operation(s) after the search.

- |                        |   |
|------------------------|---|
| <b>Enlarge Picture</b> | Double-click the picture thumbnail to enlarge it for a better view.   |
| <b>Print Picture</b>   | Select the captured picture, and click <b>Print</b> to print the selected picture.                                    |
| <b>Delete Picture</b>  | Select the captured picture, and click <b>Delete</b> to delete the selected picture.                                  |
| <b>Send Email</b>      | Select the captured picture, and click <b>Email</b> to send an email notification with the selected picture attached. |
| <b>Save Picture</b>    | Select the captured picture, and click <b>Save as</b> to save a new copy of the selected picture.                     |



## 5.8 Instant Playback

Instant playback shows a piece of the video which is remarkable, or which is unclear on the first sight. So you can play the video files instantly on the Main View page and get an immediate review if needed.

## Before You Start

Record the video files and store them on the storage devices, such as the SD/SDHC cards and HDDs on the DVRs, NVRs, network cameras, etc., or on the storage servers.

## Steps

1. Open Main View page and start the live view.
2. Perform one of the following operations to show the pre-play durations' list of instant playback.
  - Move the cursor to the display window to show the toolbar and click .
  - Right-click the display window and select **Switch to Instant Playback** on the right-click menu.
  - Move the cursor to default view or custom view node on the View panel and click .

A list with pre-play durations of 30s, 1 min, 3 min, 5 min, 8 min, and 10 min displays.

3. Select a time period from the appeared list to start the instant playback.

## Example

If you select 3 min, and the current time of the live view is 09:30:00, then the instant playback will start from 09:27:00.

During the instant playback, an indicator  appears in the upper-right corner of the display window.

4. **Optional:** Click  again to stop the instant playback and go back for the live view.

## 5.9 Live View for Fisheye Camera

For fisheye cameras, you can start the live view in fisheye mode, set presets and patrols, and perform PTZ control.

### 5.9.1 Perform Live View in Fisheye Mode



During live view of fisheye cameras, the whole wide-angle distorted view will be displayed. But you may have difficulty to view some details. To solve this problem, you can play the live videos in fisheye expansion mode. Fisheye expansion can expand images in various modes: 180° panorama, 360° panorama, PTZ, half sphere, etc. So that you can view the image clearly.

## Before You Start

Make sure you have installed Microsoft DirectX component.

## Steps

1. Open the Main View page and start the live view of fisheye camera.
2. Enter the Fisheye Expansion mode.
  - Right-click on the video and select **Fisheye Expansion**.
  - Click  in the toolbar. See [Set Icons Shown on Toolbar](#) for details about setting the toolbar.

 turns to .
3. Click  in the lower-left corner of the displaying window to open the Mounting Type & Expanding Mode Selection panel.

4. Select the mounting type of the fisheye camera according to its actual mounting position.
5. Select the expanding mode for live view as desired.

## Fisheye

In the Fisheye view mode, the whole wide-angle view of the camera is displayed. This view mode is called Fisheye because it approximates the vision of a fish's convex eye. The lens produce curvilinear images of a large area, while distort the perspective and angles of objects in the image.

## Panorama

In the Panorama view mode, the distorted fisheye image is transformed to normal perspective image by some calibration methods.

## PTZ

The PTZ view is the close-up view of some defined area in the Fisheye view or Panorama view, and it supports the electronic PTZ function, which is also called e-PTZ.



### Note

Each PTZ view is marked on the Fisheye view and Panorama view with a specific navigation box. You can drag the navigation box on the Fisheye view or Panorama view to adjust the PTZ view, or drag the PTZ view to adjust the view to the desired angle.

---

## Half Sphere

By the half sphere mode, you can drag the image and rotate it centering on the diameter, in order to adjust the view to the desired angle.

## AR Half Sphere

AR half sphere mode overlaps images far and near, so that you can view a dimensional image in a wide angle.

## Cylinder

In Cylinder mode, the image is formed into a cylinder page.

6. **Optional:** Perform the following operation(s) after starting live view in fisheye mode.

<b>Capture</b>	Right-click on the window and select <b>Capture</b> to capture the picture in the live view process.
<b>Enter Full Screen</b>	Right-click on a playing window and switch the selected window to full-screen mode.

## 5.9.2 PTZ Control in Fisheye Mode

In fisheye mode, you can control the PTZ to adjust the PTZ window.





### Note

The PTZ panel varies according to different devices.

---





The following functions are available on the PTZ control panel.

- Select a PTZ window, and click the direction buttons to adjust view angle. Or drag the No. label in the fisheye or panorama window to change the view angle of the PTZ window.
- Select a PTZ window, click  to start auto-scan (the camera rotates in a horizontal direction), and click it again to stop auto-scan.
- Drag the slider on  to adjust the speed for PTZ movement.
- Click , or scroll the mouse wheel to zoom in or zoom out the selected PTZ window.

### 5.9.3 Set a Preset and Patrol

PTZ supports configuring and calling a preset and patrol.

Enter the **Main View** page, and select **Fisheye Expansion** after right-clicking a camera.

Task	Definition	Operation
Preset	A preset links the key regions to mobile PTZ position and status. Monitoring people uses it to positioning to key regions rapidly. By sending setting preset command, mobile PTZ records the position and status of zoom, focus, and iris. When executing calling preset command, mobile PTZ rapidly rolls to the set position and resume to set status.	How to Set: select a preset from the preset list→turn the camera to a desired position→click  .
		How to Call: click  .
Patrol	Patrol is the function that users specify a scan track with a group of defined presets. The patrol between two presets is performed with the set speed and time.	How to Set: click  →select presets, and set speed and time→click <b>OK</b> .
		How to Call: click  .

### 5.10 Perform Smart Linkage

The box or bullet camera which supports smart linkage function can locate or track the target according to your demand.



## Note

- This function is only supported by the specific box or bullet camera.
  - A speed dome with the auto-tracking function is required to be installed near the box or bullet camera.
- 

## 5.10.1 Configure Smart Linkage Rule

Before performing smart linkage during live view, you should configure the smart linkage rules for the box or bullet camera, including setting VCA detection rule, linking to a speed dome, and calibrating camera and speed dome.

### Set Intrusion Detection Rule

You should set the VCA detection rule for the bullet or box camera, and when the VCA event is triggered, the client can trigger speed dome to track the target. Here we take intrusion detection as an example.

#### Steps

1. Open Device Management page and select a box or bullet camera.
2. Click  → **Advanced Configuration** → **VCA Config** → **Rule** → **Rule Settings** to enter rule settings page.
3. Click **Add** in Rule List panel to add a rule.
4. Select **Intrusion** as the event type.
5. Click  to draw a detection region on the live video.
6. Click **Save**.

### Link Speed Dome

When configuring the smart linkage for the box or bullet camera, you can link the camera to a speed dome and set the PTZ position for the speed dome for tracking.

Perform this task to link the box or bullet camera to a speed dome for smart linkage.

#### Steps

1. Open Device Management page and select a box or bullet camera.
2. Click  → **Advanced Configuration** → **Smart Linkage** to enter smart linkage settings page.
3. Click **Login** on the display window to open the speed dome login window.
4. Input the speed dome's IP address, port No., user name, and password.
5. Click **Login** to log in to the speed dome.
6. Click **PTZ** and use the direction arrows to adjust the speed dome to a horizontal position.

## What to do next

Calibrate the box or bullet camera and the linked speed dome, see [\*\*\*Calibrate Camera and Speed Dome Automatically\*\*\*](#) or [\*\*\*Calibrate Camera and Speed Dome Manually\*\*\*](#) for details.

## Calibrate Camera and Speed Dome Automatically

When setting the bullet or box camera's smart linkage rule, you should calibrate the camera and the speed dome. Two calibration modes, including auto and manual, are available, here we introduce the auto calibration.

### Before You Start

Link the camera to a speed dome, see [\*\*\*Link Speed Dome\*\*\*](#) for details.

### Steps

1. Open Device Management page and select a box or bullet camera.
2. Click  → **Advanced Configuration** → **Smart Linkage** to enter smart linkage settings page.
3. Select the calibration mode as **Auto Calibrating** in the lower-right corner of Calibration panel.
4. Move and zoom in/out the view of speed dome to make sure the live views of dome and camera are mostly same.
5. Click **Save**.



## Calibrate Camera and Speed Dome Manually

When setting the bullet or box camera's smart linkage rule, you should calibrate the camera and the speed dome. Two calibration modes, including auto and manual, are available, here we introduce the manual calibration.

### Before You Start

Link the camera to a speed dome. See [\*\*\*Link Speed Dome\*\*\*](#) for details.

### Steps

1. Open Device Management page and select a box or bullet camera.
2. Click  → **Advanced Configuration** → **Smart Linkage** to enter smart linkage settings page.
3. Select the calibration mode as **Manual Calibrating** in the lower-right corner of Calibration panel.
4. Select site No. 1 from the list and click .  
A blue cross appears in the center of the live view page, and the digital zoom view of the selected site appears on the right.
5. Repeat step 4 to add other manual calibration sites.
6. Adjust the distances among the four calibration sites evenly in the live view page.
7. Select the calibration site No. 1.  
The digital zoom view of site No. 1 appears at the right.
8. Move and zoom in or out the view of speed dome to make sure the live views of speed dome and the digital zoom view of selected site are mostly same.

9. Click  to save the current site position information.
10. Repeat step 7, 8, and 9 to set other sites' position.
11. Click **Save**.

### 5.10.2 Enable Smart Linkage

During live view, you can enable the smart linkage to locate or track the target appeared in the view of bullet or box camera with a speed dome.

#### Before You Start

Configure the smart linkage rules for the box or bullet camera.

Perform this task when you need to enable the smart linkage for box or bullet camera.

#### Steps

1. Enter the Main View page and start the live view of box or bullet camera.
2. Right-click on the live view window and click **Enable Smart Linkage**.

When the configured VCA rule is triggered by target, the linked speed dome performs the automatic smart linkage and the target frame turns from green into red.

## 5.11 Live View for Thermal Camera

For thermal camera, you can view the fire source information and temperature during live view. You can also measure the temperature manually to get temperature information in the live view image.

### 5.11.1 View Fire Source Information during Live View

During the live view, you can view the detected fire source information.

#### Before You Start

Configure the alarm rules for the thermal device, see the user manual of the device for details.

#### Steps

1. Enter Main View page and start the live view of a thermal camera.



#### Note

For starting live view, refer to ***Start Live View*** .

2. Right-click on the live view image and select **File Source Information** in the right-click menu to show the list of information types.

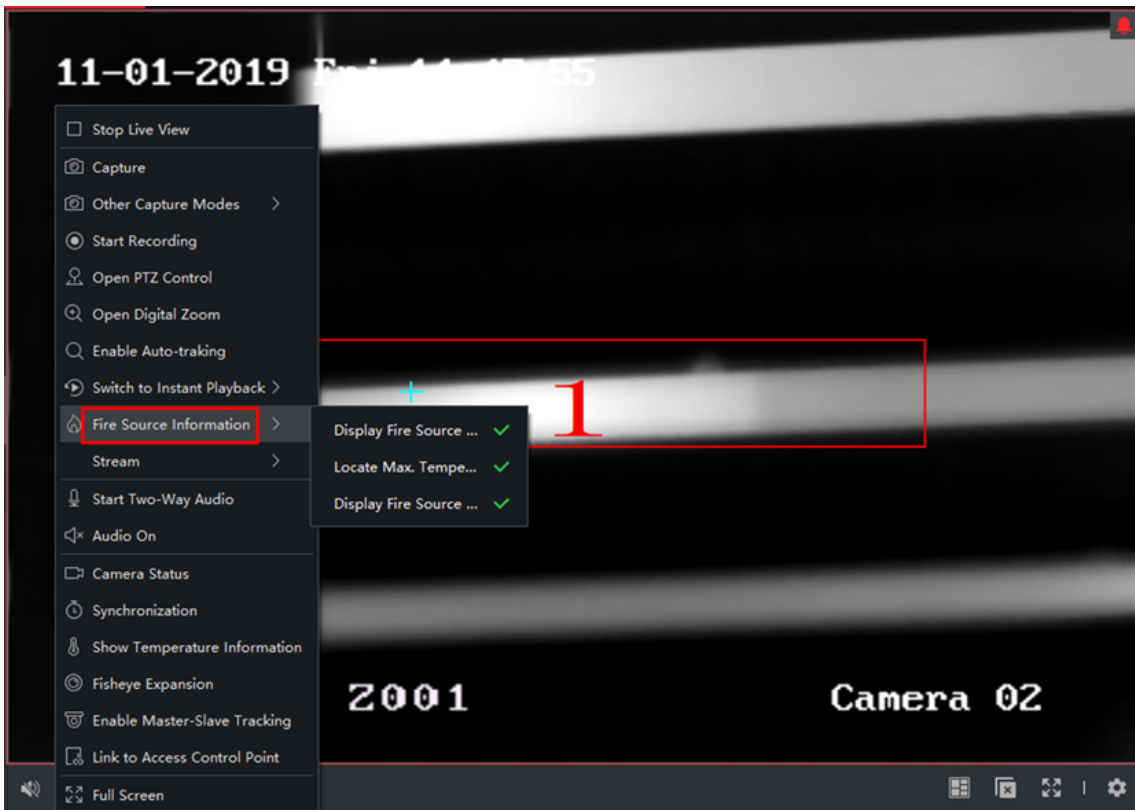

Figure 5-6 View Fire Source Information

3. Select a information type in the list to display the information.

**Display Fire Source Region**

The region in which the temperature is higher than the configured alarm threshold.

**Locate Max. Temperature Region**

Mark the region in which the temperature is highest in the fire source region. It is marked in green.

**Display Fire Source Target**

The distance between the device and fire source.

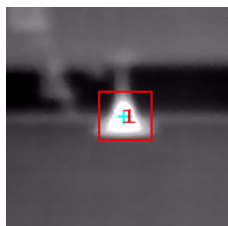

Figure 5-7 Fire Source Information on Live View Image

### 5.11.2 Show Temperature Information on Live View Image

You can show or hide the real-time temperature information of the monitoring scene when viewing the live video.

#### Before You Start

- Switch the device VCA source type as **Temperature Measurement + Behavior Analysis**.
- Enable the device temperature measurement function and set the temperature measurement rules, see the user manual of the device for details.

Perform this task when you need to show the temperature information on the live view image.

#### Steps

1. Enter Main View page and start the live view of a thermal camera.



For starting live view, refer to [Start Live View](#).

---

2. Adjust the scene to the area configured with temperature measurement rule.
3. Right-click on the live view image and select **Show Temperature Information** in the right-click menu.

The temperature displays on the live view image.

4. Click on the image to view the detailed temperature information.

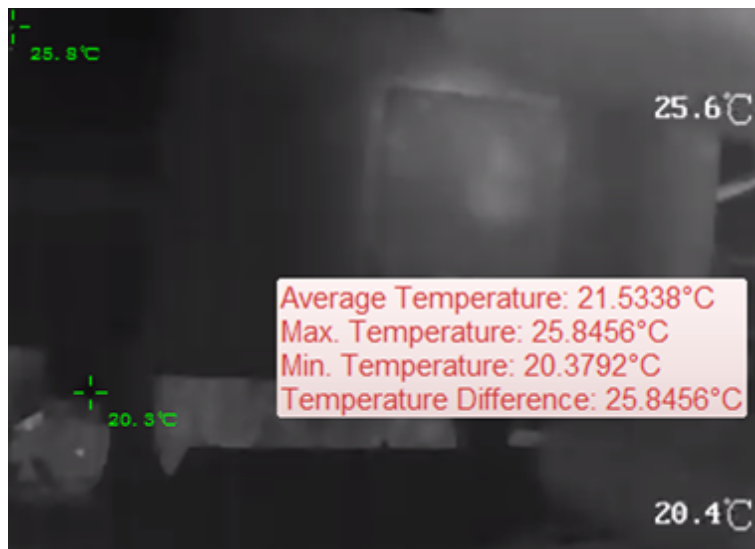

Figure 5-8 Temperature Information on Live View Image

5. **Optional:** Right-click on the live view image and select **Hide Temperature Information** to hide the temperature information.

### 5.11.3 Manually Measure Temperature

During the live view of thermal camera, you can click anywhere on the live view image to show the temperature of different points to locate the fire resource quickly.

#### Steps

---

##### Note

- The measured temperature will be displayed on the image for 5 seconds.
  - Only one point's temperature can be displayed.
  - When multiple clients are getting the live video of one camera, if one client adds or deletes the measurement points, other clients' live view will be affected as well. The measurement points will be cleared if all users stop live view of the camera.
- 

1. Enter Main View page and start the live view of a thermal camera.
- 

##### Note

For starting live view, refer to **Start Live View** .

---

2. Right-click on the live view image and select **Show Temperature Information**.
3. Click on the live view image to show the temperature of this position.

The temperature of the clicked points is shown on the image.

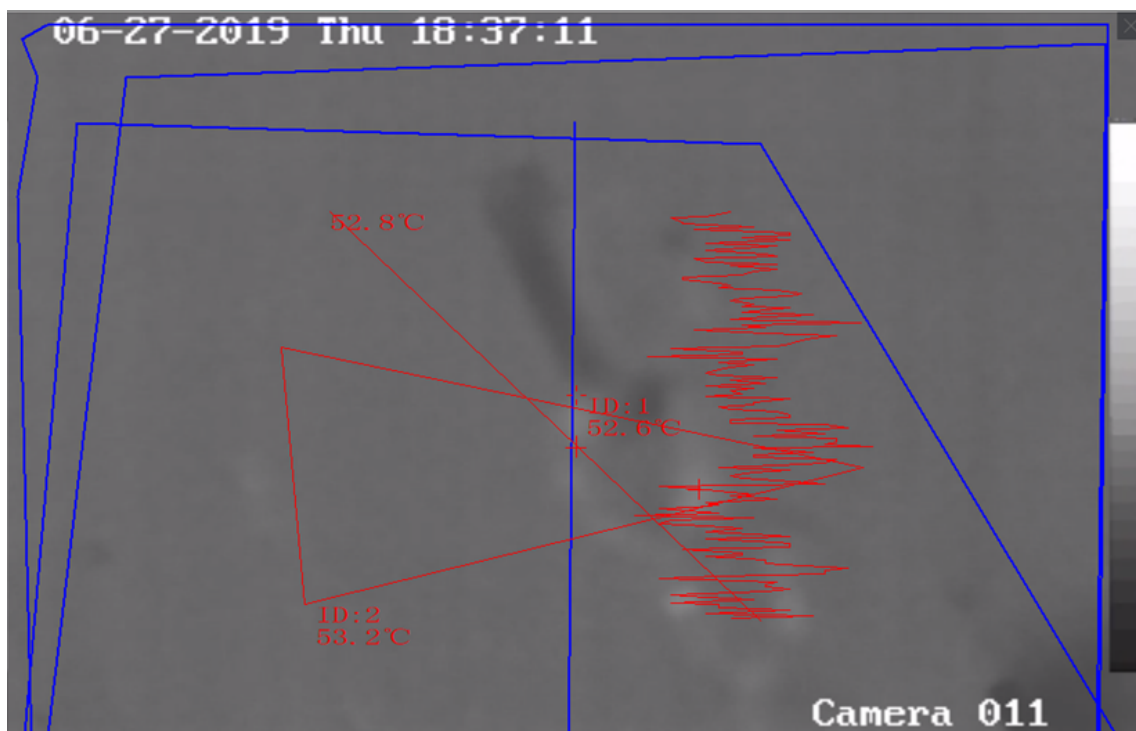

Figure 5-9 Manually Measure Temperature on Points

**4. Optional:** Right-click on the live view image and select **Hide Temperature Information** on the menu.

#### 5.11.4 Display Fire Source Detection Shield Area

Fire source detection shield area is a predefined area that can be shielded from being detected in fire source detection. During live view, you can display the area on the image.

Right-click a live view image and select **Display Shield Area**. The shield area will be displayed on the thermal image of the camera.

---

#### Note

- This function needs to be supported by device.
  - Make sure you have enabled and configured Fire Source Detection Shield function for the device. See the device user manual for details.
- 

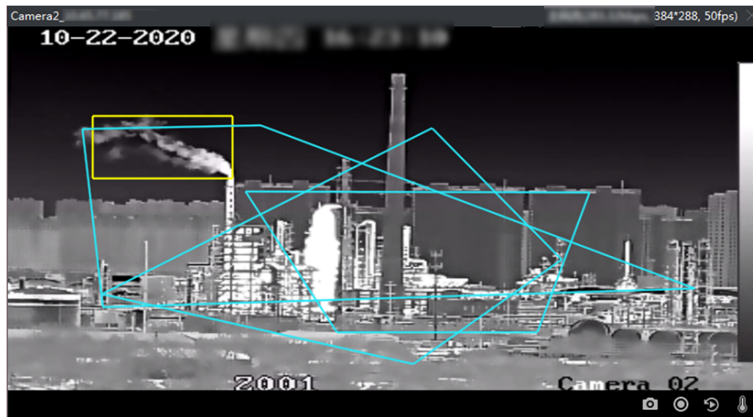

Figure 5-10 Fire Source Shield Area

#### 5.11.5 Display Waste Gas Information

For the device supports waste gas information detection, you can enable **VCA Rule** on the System Configuration page to display the waste gas information during live view.

See **Set Image Parameters** for details about how to enable **VCA Rule**.



**Figure 5-11 Display Waste Gas Information**

## 5.12 Live View in Low Bandwidth

In situation of low network bandwidth, the speed of video streaming might be much slower due to the bandwidth limit. To provide normal quality in less streaming speed for low bandwidth users, the client provides live view in low bandwidth mode. Before that, you need to set the streaming protocol and perform other operations first.

For details about the settings, refer to **How to get better performance of live view and playback when network bandwidth is low?** .

## 5.13 More Functions

There are some more functions supported in the live view, including auxiliary screen preview, digital zoom, channel-zero, two-way audio, camera status, and synchronization.

### Auxiliary Screen Preview

Display the live video on different auxiliary screens for the convenient preview of multiple monitoring scenes.

---

#### Note

Up to 3 auxiliary screens are supported.

---

### Digital Zoom

Drag the mouse to draw a rectangle area in the lower-right/upper-left direction to zoom in or out the drawn area. Or use the mouse wheel to zoom in or out the view in digital zoom mode.



## Channel-Zero

For the channel-zero of the device, hold the **Ctrl** key and double-click to display the specific channel. Hold the **Ctrl** key and double-click again to restore.

## Two-Way Audio

Two-way audio function enables the voice talk of the camera. You can get not only the live video but also the real-time audio from the camera. If the device has multiple two-way audio channels, you can select a channel to start two-way audio.

---

### Note

- The two-way audio can be used for only one camera at one time.
  - Hik-Connect device doesn't support selecting channel during two-way audio.
- 

## Camera Status

The camera status, such as recording status, signal status, connection number, etc., can be detected and displayed for checking. The status information refreshes every 10 seconds.

## Synchronization



The synchronization function provides a way to synchronize the device clock with the PC which runs the client software.

## Set Stream Type

### Auto-Change Stream Type

Camera selects stream type according to its display window size. When the window division number is smaller than 9, the stream type will be main stream, otherwise sub stream.

Three ways are provided for setting stream type:

- In the resource list, hover the cursor on a camera's name and click  → **Stream** to select a stream type, or click **Auto-Change Stream Type**. Or you can perform this operation for a device group to set stream type for all devices in this group.
  - Click  in the live view tool bar and select a stream type. See [Set Icons Shown on Toolbar](#) for details about editing tool bar.
  - Right-click a live view window and click **Stream** to select a stream type for the camera.
- 

### Note

This function needs to be supported by device.

---

## Lock Client in Full Screen Mode

Press **Ctrl** and **L** on your keyboard to lock the client after entering the full screen mode. After locking the client, you will be unable to operate the client including the other windows in the current window division mode. Click **Unlock** on the top and enter the login password for the client and click **Unlock** to unlock the client.

## Chapter 6 Remote Playback

The device records the video according to the recording schedule. You can view the video files stored in the storage server and the local device, to restore the event occurrence process for postmortem analysis and make the further judgment. Storing the valued video footage can provide basic materials for video analysis and video proof. The client supports multiple playback modes, such as: VCA playback, event playback, etc.

---

 **Note**

There are two playback modes: one is the instant playback in the Main View module (refer to ***Instant Playback*** for details), another one is searching video files and play the video files in the Remote Playback module. In this chapter, we only introduce the playback in the Remote Playback module.

---

### 6.1 Flow Chart

Please follow the steps in the following flow chart for playback.

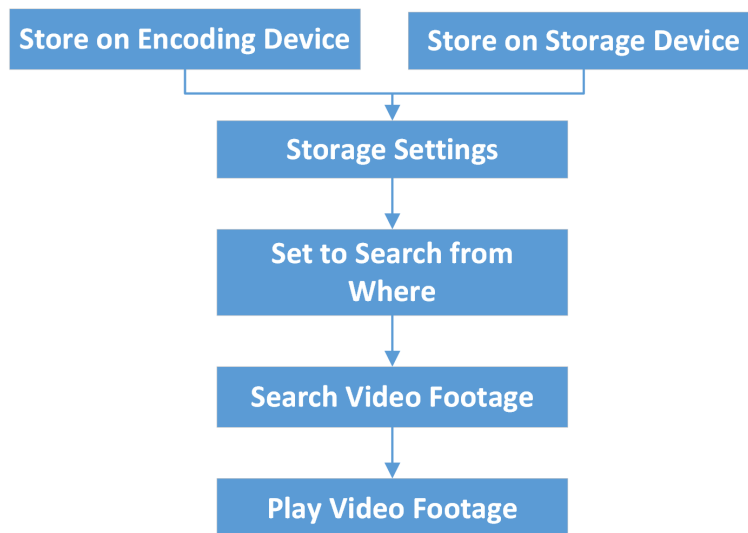

**Figure 6-1 Flow Chart of Playback**

- **Storage Settings:** Set recording schedule to define when the cameras start recording and where the video footage are stored. For details, refer to ***Remote Storage Configuration*** .
- **Search and Play Video Footage:** Start playback. For details, refer to the contents in this chapter.

## 6.2 Remote Storage Configuration

The video files and captured pictures can be stored on the HDDs, Net HDDs, or SD/SDHC cards on the local device, or on the storage server connected.



This function should be supported by the device.

---

### 6.2.1 Store Picture and Video on DVR, NVR, or Network Camera

Some local devices, including the DVRs, NVRs, and Network Cameras, provide storage devices such as the HDDs, Net HDDs and SD/SDHC cards for video and picture files. You can set a recording schedule or capture schedule for the channels of the local devices.

#### Before You Start

Make sure the newly installed storage devices have been formatted. Refer to [\*\*\*Format Storage Server's HDD\*\*\*](#) for details.

Perform this task when you need to store the picture and video files on the encoding device such as DVR, NVR, or network camera.

#### Steps



The pictures captured through the capture schedule are stored on the local device and can be searched on the remote configuration page of the device.

---

1. Enter the Storage Schedule module.
2. Select the camera in the Camera Group list.
3. Set **Recording Schedule** switch or **Capture Schedule** switch to ON on **Storage on Encoding Device** area to enable device local recording or capture.
4. Select the recording or capture schedule template from the drop-down list.

#### All-day Template

All-day continuous recording.

#### Weekday Template

Working-hours continuous recording from 8:00 AM to 8:00 PM.

#### Event Template

All-day event triggered recording.

#### Template 01 to 08

Fixed templates for specific schedules. You can edit the templates if needed.

#### Custom

Customize a template as you want.

---

 **Note**

If you need to edit or customize the template, refer to ***Configure Recording Schedule Template*** or ***Configure Capture Schedule Template***.

- 
5. Click **Advanced** of Recording Schedule to set the recording advanced parameters.

---

 **Note**

The displayed items vary according to the devices.

---

**Pre-record**

Normally used for the event triggered record, when you want to record before the event happens.

**Post-record**

After the event finished, the video can also be recorded for a certain time.

**Keep Video Files for**

The time for keeping the video files in the storage device, once exceeded, the files will be deleted. The files will be saved permanently if the value is set as 0.

**Redundant Recording**

Save the video files not only in the R/W HDD but also in the redundant HDD.

**Record Audio**

Record the video files with audio or not.

**Video Stream**

Select the stream type for the recording.

---

 **Note**

For specific type of devices, you can select **Dual-Stream** for recording both main stream and sub-stream of the camera. In this mode, you can switch the stream type during remote playback. Refer to ***Normal Playback*** for stream switch during playback.

- 
6. Click **Advanced** of Capture Schedule to set the capture advanced parameters.

**Resolution**

Select the resolution for the continuous or event captured pictures.

**Picture Quality**

Set the quality for the continuous or event captured pictures.

**Interval**

Select the interval which refers to the time period between two capturing actions.

**Captured Picture Number**

Set the picture number for event capture.

7. **Optional:** Click **Copy to...** to copy the recording schedule settings to other channels.

8. Click **Save** to save the settings.

### 6.2.2 Store Video on Storage Device

You can store the video footage recorded by the added encoding devices on the storage devices managed in the client.

You can add storage device to the client for storing the video files of the added encoding devices and you can search the files for remote playback. The storage device can be CVR (Center Video Recorder) or NVR.

### Add Storage Server to Client

You can add storage server to the client for storing the video files of the added encoding devices.

#### Steps

1. Enter the Device Management module.

2. Click **Device** tab.

The added devices are displayed in the list.

3. Add iVMS-4200 Storage Server.

- You can add online storage server. For details, refer to [Add Single or Multiple Online Devices](#) .

- You can add storage server via IP address or domain name. For details, refer to [Add Device by IP Address or Domain Name](#)

### Format Storage Server's HDD

You should format the HDDs of the storage server for the video file storage.

Perform this task to format storage server's HDD.

#### Steps



Formatting the HDDs is to pre-allocate the disk space for storage and the original data of the formatted HDDs will not be deleted.

---

1. Enter the Device Management module.

2. Click **Device** tab.

The added devices are displayed in the list.

3. Select the added storage server from the list.

4. Click  .

5. Click **Storage** → **General** to enter the HDD Formatting window.

6. Select the HDD from the list and click **Format**.

You can check the formatting process from the process bar and the status of the formatted HDD changes from **Unformatted** to **Normal Status**.

### Configure Storage Settings

When the storage server is available, you can set the recording schedule for the cameras.

#### Before You Start

The newly installed storage devices need to be formatted.

#### Steps

1. Enter **Storage Schedule** module.
2. Select the camera in the Camera Group list.
3. Select a storage server from the **Storage Server** drop-down list.
4. Set **Recording Schedule** switch to ON to enable storing the video files.
5. Select the schedule template for recording from the drop-down list.



If you need to edit or customize the template, refer to [\*\*\*Configure Recording Schedule Template\*\*\*](#) .

6. **Optional:** For Recording Schedule, click **Advanced** to set the pre-record time, post-record time, video stream, and other parameters.



The iVMS-4200 Storage Server only supports main-stream.

7. Click **Save** to save the settings.

### 6.2.3 Store Picture and Additional Information on Local PC

You can store the pictures and the additional information, such as the heat map, people counting data, and road traffic data, to the local PC.

Perform this task when you need to store pictures and additional information on local PC.

#### Steps

1. Enter **Storage Schedule** module.
2. Select the camera in the Camera Group list.



This function should be supported by the device.

3. Select storage content.

#### Picture Storage

Store the alarm pictures of the camera when event occurs. You can click **System Configuration** → **File** to modify the saving path of pictures.

## Additional Information Storage

Store the additional information (e.g., heat map, people counting data, etc.) on local PC.

4. Click **Save** to save the settings.

## 6.2.4 Configure Recording Schedule Template

You can edit the recording schedule template, or customize a recording schedule template.

### Steps

1. Enter the Storage Schedule module.
2. Open the template settings window.
  - Select **Template 01** to **Template 08** from the drop-down list and click **Edit**.
  - Select **Custom** from the drop-down list.
3. Drag on the time-line to set the time periods for the selected template when the cursor turns to  .

### Continuous

Normal and continuous recording. The schedule time bar is marked with  .

### Event Recording

The recording is triggered by event. The schedule time bar is marked with  .

### Command

The recording triggered by command. The schedule time bar is marked with  .



### Note

Command triggered recording is only available for the ATM transactions when the ATM DVR is added to the client.

---







### Note

Up to 8 time periods can be set for each day in the recording schedule.

---

4. **Optional:** After setting the time periods, you can do one or more of the following:

- |                            |   |
|----------------------------|---|
| <b>Move</b>                | Drag a time period to move it when the cursors turns to  .                           |
| <b>Lengthen or Shorten</b> | Select a time period and then lengthen or shorten it when the cursor turns to  .       |
| <b>Set Accurate Time</b>   | Click a time period to set the accurate start time and end time of the period.  |
| <b>Delete</b>              | Select the configured schedule time period and click  to delete it.                  |
| <b>Delete All</b>          | Click  to delete all the configured time periods.                                      |
| <b>Copy to</b>             | Select one date and click  to copy the date's time period settings to the other dates. |

5. **Optional:** For template 01 to 08, you can edit the template name as you want.

6. Click **OK** to save the settings.

---

 **Note**

If you select **Custom** to customize a template, you can click **Save as Schedule Template**, and then the custom template can be saved as template 01 to 08.

---

## 6.2.5 Configure Capture Schedule Template

You can edit the capture schedule template, or customize a capture schedule template.

### Steps

1. Enter the Storage Schedule module.
2. Open the template settings window.
  - Select **Template 01** to **Template 08** from the drop-down list and click **Edit**.
  - Select **Custom** from the drop-down list.
3. Drag on the time-line to set time periods for the selected template when the cursor turns to .





#### Continuous Capture

Normal and continuous capture. The schedule time bar is marked with .

#### Event Capture

The capture is triggered by event. The schedule time bar is marked with .

4. **Optional:** After setting the time period, you can do one or more of the followings

<b>Move</b>	When the cursor turns to  , you can move the time period you just edited. You can also edit the displayed time point to set the accurate time period.
<b>Lengthen or Shorten</b>	When the cursor turns to  , you can lengthen or shorten the selected time period.
<b>Delete</b>	Select a time period and click  to delete it.
<b>Delete All</b>	Click  to delete all the configured time periods.
<b>Copy to</b>	Select one date and click  to copy the date's time period settings to the other dates.

5. **Optional:** For template 01 to 08, you can edit the template name as you want.

6. Click **OK** to save the settings.

---

 **Note**

If you select **Custom** to customize a template, you can click **Save as Schedule Template**, and then the custom template can be saved as template 01 to 08.

---



## 6.3 Toolbar for Playback

When playing back video on the Remote Playback module, you can operate the tools in the toolbar to implement different functions.

### Note

The tools in different playback modes might be different. In this section, you will introduce the tools in the Camera Playback module.

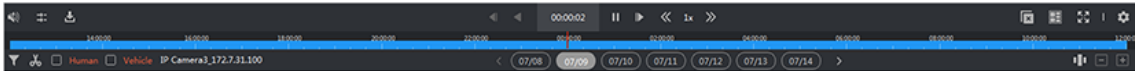

















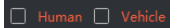



Figure 6-2 Toolbar for Playback

Table 6-1 Toolbar for Playback

Icon	Icon Name	Descriptions
	Reverse Playback	Play back the video file(s) reversely.
	Pause/Play	Pause/play the video file(s).
	Close All	Close all the playing video file(s).
	Single Frame Frame(Reverse)	Play the video file(s) by frame reversely.
	Single Frame	Play the video file(s) by frame.
	Slow Forward/ Fast Forward	Set the rate of playing, and play back the video file(s) slowly or fast according to the rate.
	Volume	Click this icon to open/close the audio and adjust the volume.
	Clip	Set the start and end time for clipping and download the clipped video file to the local disk.
	Download for Multiple Cameras	Set the start time and end time for multiple cameras and download the video files of multiple cameras simultaneously.
	Window Division	Set the window division.
	Full Screen	Play back video file(s) in full screen. Press <b>ESC</b> to exit.
	Asynchronous Playback/	Switch to asynchronous/synchronous playback mode.

Icon	Icon Name	Descriptions
	Synchronous Playback	 <b>Note</b> For details, refer to <i><b>Synchronous Playback</b></i> .
	Settings	Enter the Video Parameters Settings module, configure the parameters for live view and playback, image, files and toolbar.
	Filter	Filter the video files by the recording type.
	Accurate Positioning	Set the accurate time to play back video file(s).
	Video Date	The date of the playing video file(s) currently. You can switch to play back the video file(s) on the other date quickly.  For example, if you switch the date to 07/30, the video will be automatically displayed from 00:00 on July 30 (if there is video at this time).
	Filter Human or Vehicle Related Video	Check <b>Human</b> or <b>Vehicle</b> to filter the video with human body detected or vehicle detected. The human or vehicle related video will be remarked in orange on the time bar, and you can quickly locate the video on the time bar.   <b>Note</b> This function should be supported by the device, otherwise the <b>Human</b> or <b>Vehicle</b> is gray and can not be checked.

## 6.4 Normal Playback

You can search video files by camera or group for normal playback and download found video files to local PC. You can also add a tag to mark important video footage, and so on.

You can right-click the playback window to select the required operations from the shortcut menu. Some are listed as follows:

Name	Description
Show/Hide Temperature Information	Show/Hide Temperature Information

Name	Description
	 <b>Note</b> The temperature information overlay is only supported by thermal camera.
Tag Control	Add default (the default tag name is TAG) or custom tag (the tag name is customized) for the video file to mark the important video point. You can also edit the tag or go to the tag position conveniently.
Other Capture Modes	<ul style="list-style-type: none"> <li>• <b>Print Captured Picture:</b> Capture a picture and print it.</li> <li>• <b>Send Email:</b> Capture the current picture and then send an Email notification to one or more receivers. The captured picture can be attached.</li> <li>• <b>Custom Capture:</b> Capture the current picture. You can edit its name and then save it.</li> </ul>



 **Note**

- The Hik-Connect device only supports normal playback and it also does not support the functions of reverse playback, slow forward or fast forward, and adding tag.
- For NVR which is added to the client by device's other user name (except admin), if **Double Verification** is enabled on this NVR, when playing back videos on the client, you are required to enter the user name and password created for double verification. For details about double verification, refer to the user manual of the NVR.



### 6.4.1 Search Video Footage

You can search the video footage by date, and you can also enter keyword to filter the matched results for normal playback.

**Steps**

1. Enter the Remote Playback module.
2. Click  on the left to enter the Camera Playback page.
3. **Optional:** Click  to set the start date and end date of searching time period.

 **Note**

In the calendar, the date which has video footage recorded by schedule will be marked with , and the date which has video footage recorded based on event will be marked with .

4. Start the playback of camera (s) to search the video footage of the selected camera (s). You can do one of the followings to start the playback.

## Note

Up to 16 cameras can be searched simultaneously.

- Drag the camera or group to a display window.
- Select a display window and double-click the camera or group to start playback in the selected window.
- Double-click the cameras in turn to select the display window automatically and start playback in the windows.

## 6.4.2 Play Video Footage

After searching the video footage for the normal playback, you can play the video via time line.

### Steps

1. Enter the Remote Playback module.
2. Search the video footage.
3. Play video via time line.

The video footage will play automatically. You can click on the time line to position the desired video segment of specified time for normal playback.

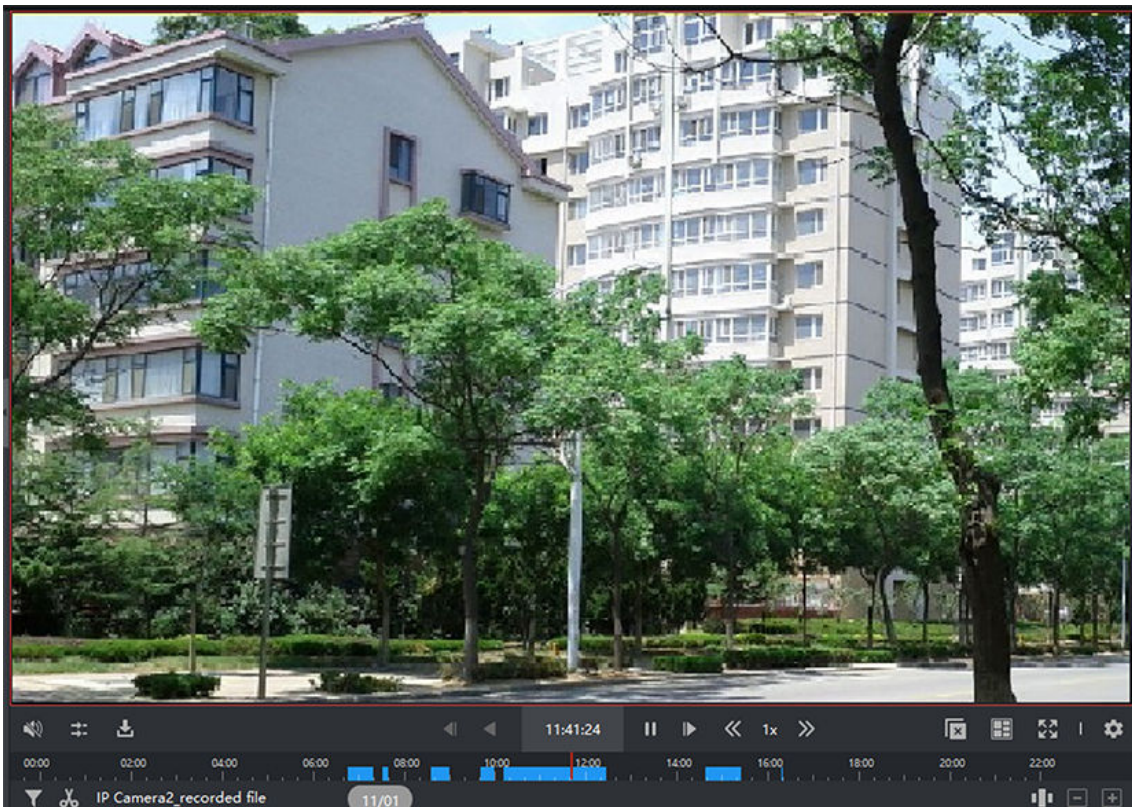



Figure 6-3 Playback of Video Footage



---



## Note

- The time line indicates the time duration for the video footage, and the video footage of different types are color coded. During playback, you can view the bitrate, frame rate and resolution information on the image.
- You can use mouse wheel or click  /  to scale up or scale down the time line bar.

---

## 4. Optional: Perform the following operations on the toolbar to control the playback.

**Single Frame (Reverse)** Click   or scroll down the mouse wheel to play the video footage frame by frame (reversely).

**Audio Control** Click  or  to turn off/on the sound. You can also adjust the volume when turning on.

**Download for Multiple Cameras** Click  to download video footage of multiple cameras at the same time.

---

## Note

For more details, refer to [\*\*\*Download for Multiple Cameras\*\*\*](#) .

---

**Download Video Files by Date** Click  to download the video footage of the camera by date and time, and store them to local PC. The downloading progress is displayed on the right-upper corner of the page, and you can manually pause downloading.

**Accurate Positioning** Click **2018/10/19 08:56:11** to set the accurate time point to play the video file.

**Jump to the Image of a Thumbnail** Click  in the lower-right corner to enable thumbnail function, and put the cursor on the timeline to show the thumbnail of the point. Click the thumbnail to jump to the image of it.

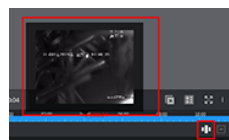

**Figure 6-4 Playback Thumbnail**

---

## Note

This function needs to be supported by devices.

---

## 6.5 Alarm Input Playback

When the alarm input is triggered and the linked video can be searched for alarm input playback. This function requires the support of the connected device.

For the description of the alarm input playback toolbar and right-click menu of display window, refer to ***Normal Playback*** .

---





Some icons may be not available for alarm input playback.

---

### 6.5.1 Search Video Footage

You can search the video footage by date, and you can also enter keyword to filter the matched results for alarm input playback.

#### Steps

1. Enter the Remote Playback module.
2. Click  on the left to enter the Event Playback page.
3. Select an alarm input channel at the left.
4. **Optional:** Click  to set the start date and end date of searching time period.
5. Select **Alarm Input** from the drop-down list as the event type.
6. Click **Search** to start the search.

The matched video footage of the selected alarm input will display on the right page in chronological order. And by default, the first video will play automatically.

7. **Optional:** Enter keyword in the **Search** field to filter the results.

### 6.5.2 Play Video Footage

After searching the video footage for the alarm input playback, you can play the video via file list or timeline.

#### Steps

1. Enter the Remote Playback module.
  2. Click  on the left to enter the Event Playback page.
  3. Search the video footage of the alarm input.
- 



See ***Search Video Footage*** for details about searching video footage of the alarm input.



---

4. Play video via file list or timeline.
    - Double-click the video footage to play the video in the playback display window.
-

- Click on the timeline to positioning the desired video segment of specified time for alarm input playback.

---

### Note

- The timeline indicates the time duration for the video footage, and the video footage of different types are color coded.
  - You can use mouse wheel or click  /  to scale up or scale down the timeline bar.
- 

## 6.6 Event Playback

The recorded video files triggered by event, such as motion detection, VCA detection, or behavior analysis, can be searched for event playback. This function requires the support of the connected device.

For the description of the event playback toolbar and right-click menu of display window, refer to ***Normal Playback*** .

---

### Note



Some icons may be not available for event playback.

---

### 6.6.1 Search Video Footage/Picture



You can search event videos/pictures by date and event type.

#### Steps

1. Enter the Remote Playback module.
2. Click  on the left to enter the Event Playback page.
3. Click  to set the start date and end date of searching.

---

### Note

In the calendar, the date which has video footage recorded by schedule will be marked with , and the date which has video footage recorded based on event will be marked with .

4. Select **Video** or **Picture** as the content to search for.
5. Select a camera from the resource list.
6. Select an event type from the **Event Type** drop-down list.
7. Click **Search**.
  - If you select **Video** as the searched content, the matched video footage will display on the right page in chronological order. And by default, the first video file will play automatically.
  - If you select **Picture** as the searched content, the matched pictures will be automatically displayed on the right page.



## 6.6.2 View Video Footage/Picture

When the camera detects events (such as line crossing, motion detection, behavior analysis) happening or the outdoor station performs video talk, it will trigger the linked camera's recording video or capturing pictures. You can search the video footage or pictures and play the videos via file list or timeline and view the pictures in turn.

### Steps

---



#### Note

For the outdoor station, only DS-KV8123-M supports the following operations.









---

1. Enter the Remote Playback module.
  2. Click  on the left to enter the Event Playback page.
  3. Search the video footage or pictures recorded/captured based on event.
  4. View video footage or picture.
    - Double-click the video footage to play the video in the playback display window.
    - Searched pictures will be automatically played.
- 

#### Note

- The timeline indicates the time duration for the video files, and the video files of different types are color coded.
  - You can use mouse wheel or click  /  to scale up or scale down the timeline bar.
- 

5. **Optional:** Perform the following operations if you need.

<b>Play Footage of Certain Time</b>	Click on the timeline to display video segment of specified time for event playback.
<b>Display Footage with Human and/or Vehicle</b>	Under the timeline, check <b>Human</b> and/or <b>Vehicle</b> to display footage contains humans or vehicles.
<b>Switch Pictures</b>	Click  or  to turn to previous or next picture.
<b>Set Picture Displaying Interval</b>	Click  to set the interval of picture display.
<b>Display Pictures in Full Screen</b>	Click  to display pictures in full screen mode.
<b>Display Pictures in List Mode</b>	Click  to display pictures in list mode. Click  to switch to thumbnail mode.
<b>Download Pictures</b>	Click  and check pictures and click <b>Download</b> to download the selected pictures to your PC.
<b>Download Videos</b>	Click  , select multiple video files and click <b>Download</b> to download video files to your PC.



## 6.7 ATM Playback

You can search the video files of ATM DVR for ATM playback. This function requires the support of the connected device which is configured with transaction rule.

For the description of the ATM playback toolbar and right-click menu of display window, refer to **Normal Playback**.





Some icons may be not available for ATM playback.

---

### 6.7.1 Search Video Footage

You can search the video footage of ATM DVR by card number, by transaction type, by transaction amount, by file type, or by date. And you can also enter keyword to filter the matched results for ATM playback.

#### Steps

1. Enter the Remote Playback module.
2. Click  on the left to enter the ATM Playback page.
3. Select the camera of ATM DVR at the left.
4. **Optional:** Click  to set the start date and end date of searching time period.
5. Set the search conditions.

#### by Card Number

Enter the card number contained in the ATM information.

#### Search by Transaction Type

Select transaction type for search, and enter the related transaction amount.

#### File Type

Select the type of video files for search.

6. Click **Search** to start searching.

The matched video footage of selected ATM DVR will display on the right of the Remote Playback page in chronological order. By default, the first video will play automatically.

7. **Optional:** Enter keyword in the **Search** field to filter the results.

### 6.7.2 Play Video Footage

After searching the video footage of the cameras connected with ATM DVR, you can play the video via file list or timeline.



#### Steps

1. Enter the Remote Playback module.

2. Click  on the left to enter the ATM Playback page.
3. Search the video footage of cameras connected with ATM DVR.
4. Play the video footage.
  - Double-click the video footage to play the video in the playback display window.
  - Click on the timeline to positioning the desired video segment of specified time for ATM playback.



### Note

- The timeline indicates the time duration for the video files, and the video files of different types are color coded.
  - You can use mouse wheel or click  /  to scale up or scale down the timeline bar.
- 

## 6.8 POS Playback

You can search the video files which contain POS information for POS playback. This function requires the support of the connected device which is configured with POS text overlay.

For the description of the POS playback toolbar and right-click menu of display window, refer to **Normal Playback**.

---



### Note



Some icons may be not available for POS playback.

---

### 6.8.1 Search Video Footage

You can search the video footage which contain POS information by keywords or by date.

#### Steps

1. Enter the Remote Playback module.
2. Click  on the left to enter the POS Playback page.
3. Select the camera at the left.
4. **Optional:** Click  to set the start date and end date of searching time period.
5. Set the search conditions.

#### Keywords

Enter the card number contained in the ATM information.

---



### Note

Up to three keywords can be entered for once. And each two keywords should be separated with a comma.

---

#### Combination Mode

For more than one keyword, you can select "or (|)" to search the POS information containing any of the keywords, or select "and(&)" to search the POS information containing all of the keywords.

### Case Sensitive

Check **Case Sensitive** to search the POS information by case-sensitive keywords.

#### 6. Click **Search** to start searching.

The video footage contain POS information will display on the right of the POS Playback page in chronological order. And by default, the first video file will play automatically.

#### 7. **Optional:** Enter keyword in the **Search** field to filter the results.

## 6.8.2 Play Video Footage

After searching the video footage which contain POS information, you can play the video via file list or timeline.

### Before You Start



Start the normal playback of cameras configured with POS information overlay.

### Steps

1. Enter the Remote Playback module.
2. Click  on the left to enter the POS Playback page.
3. Search the video footage which contain POS information.
4. Play video via file list or timeline.
  - Double-click the video footage to play the video in the playback display window.
  - Click on the timeline to positioning the desired video segment of specified time for POS playback.



### Note

- The timeline indicates the time duration for the video files, and the video files of different types are color coded.
  - You can use mouse wheel or click  /  to scale up or scale down the timeline bar.
- 

## 6.9 VCA Playback

For the searched video files, you can set VCA rule to find the video footage that VCA event occurs, such as motion detection, line crossing detection, and intrusion detection. This function helps to search out the video that you may be more concerned and mark it with red color.

### Before You Start

Make sure the device with VCA function has been installed.



## Steps

---

### Note

VCA playback is only supported in a single window, synchronous and asynchronous playback are not supported.

---

1. Enter the Remote Playback module.
2. Click  on the left to enter the Camera Playback page.
3. Select the camera and start the camera's video playback.
4. Enter the VCA Search menu.
  - Right-click the playback window to pop up the shortcut menu, and then click **VCA Search**.
  - Click  on the lower-right corner of the playback window.
5. Enable the VCA type, draw the detection region and set the sensitivity.

### **Motion Detection**

When the view of the video changes (such as a person passes, the lens is moved), the video footage will be marked as red color on the time line, which is used for the automatic alarm scene or no-guard scene.

### **Line Crossing Detection**

You can draw a virtual line on the video, and the video footage will be marked as red color on the time line when the client bi-directionally detects people, vehicles and other moving objects that cross the virtual line.

### **Intrusion Detection**

You can draw a virtual region on the video, and the video footage will be marked as red color on the time line when there are people, vehicles and other moving objects intruding into the pre-defined region.

### **VCA Settings**

Set the sensitivity and filter the searched video files by setting the target characters, such as the gender and age of the human and whether he/she wears glasses. The video footage will be marked as red color on the time line when a person (whose attributes match the setting attributes) occurs in the video.

---

### Note

The higher the sensitivity, the more accurate the matched person is.

---

6. **Optional:** Click  to set the start date and end date of searching time period.
7. Start the VCA playback.

The VCA events occurred in the defined area will be red marked on the timeline.

---

## Note

- By default, the playback speed of concerned video will be 1X, and the playback speed of unconcerned video will be 8X.
  - You can set to skip the unconcerned video during VCA playback in System Configuration and the unconcerned video won't be played during VCA playback. Refer to **Set Live View and Playback Parameters** for details.
  - If you need to disable VCA playback, right-click the VCA playback window and click **VCA Search** to disable VCA playback.
- 

## 6.10 Synchronous Playback



By default, the client plays the video files of multiple cameras in asynchronous playback mode: the playback time of different video files might be different. In synchronous playback, the video files can be played back in synchronization.

### Steps

---

#### Note

- Video files from up to 16 cameras can be played back simultaneously.
  - Synchronous and asynchronous playback are not supported in ATM video playback and VCA playback mode.
  - Event video playback and POS video playback only support synchronous playback. To link multiple cameras, enter **Maintenance and Management** → **Event Management**, enable the linked camera according to event type.
- 

1. Enter the Remote Playback module.
2. Start playback of at least two cameras.
3. Click  in the toolbar to enable the synchronous playback.  
The camera under playback will start synchronous playback.
4. Click  to disable the synchronous playback.

## 6.11 Fisheye Camera's Video Playback

When playing back the fisheye camera's video, there might be distortion in the view. To observe the details better, you can enable the fisheye expansion function, to rectify the view as an undistorted view. The client supports multiple fisheye expansion modes, such as: panorama, half sphere, PTZ, fisheye+PTZ mode.

### Before You Start

Make sure you have installed Microsoft DirectX component.

## Steps

---

### Note

For other playback control instruction, refer to ***Normal Playback*** . Some icons may not be available for fisheye playback.

---

1. Enter the Remote Playback module.
  2. Select a fisheye camera to start playback.
- 

### Note

For detailed configuration about playback and playback control, refer to ***Normal Playback*** .



---

3. Enter the Fisheye Expansion mode.
    - Right-click on the display window and select **Fisheye Expansion**.
    - Click  in the toolbar. See ***Set Icons Shown on Toolbar*** for details about setting the toolbar.
- 

### Note

The mounting type in playback of fisheye expansion is set according to the mounting type in live view. For details, refer to ***Perform Live View in Fisheye Mode***

---

 turns to .

4. Click  in the lower-left corner of the display area to select an expanding mode for playback as you desired.

## Fisheye

In the Fisheye view mode, the whole wide-angle view of the camera is displayed. This view mode is called **Fisheye** because it approximates the vision of a fish's convex eye. The lens produces curvilinear images of a large area, while distorting the perspective and angles of objects in the image.

## Panorama / Dual-180° Panorama / 360° Panorama

In the Panorama view mode, the distorted fisheye image is transformed to normal perspective image by some calibration methods.

## PTZ

The PTZ view is the close-up view of some defined area in the Fisheye view or Panorama view, and it supports the electronic PTZ function, which is also called e-PTZ.

---

### Note

Each PTZ view is marked on the Fisheye view and Panorama view with a specific navigation box. You can drag the navigation box on the Fisheye view or Panorama view to adjust the PTZ view, or drag the PTZ view to adjust the view to the desired angle.

---

## Half Sphere

By the half sphere mode, you can drag the image and rotate it centering on the diameter, in order to adjust the view to the desired angle.

## AR Half Sphere

AR half sphere mode overlaps images far and near, so that you can view a dimensional image in a wide angle.

## Cylinder

In Cylinder mode, the image is formed into a cylinder page, and you can drag the image to any direction flexibly to view everywhere of the detection area.

5. **Optional:** Right-click on a playing window in the Fisheye view mode and you can switch the selected window to full-screen mode.



You can right-click on the window and select **Quit Full Screen** to exit the full-screen mode.

---

## 6.12 Playback in Low Bandwidth

In situation of low network bandwidth, the speed of video streaming might be much slower due to the bandwidth limit. To provide normal quality in less streaming speed for low bandwidth users, the client provides playback in low bandwidth mode. Before that, you need to set the streaming protocol and perform other operations first.

For details about the settings, refer to [\*\*\*How to get better performance of live view and playback when network bandwidth is low?\*\*\*](#) .

## 6.13 Download Video Footage

During playback, you can download the video files of one camera or multiple cameras to the local PC.



- You can download the video files of the devices added by Hik-Connect.
  - For NVR which is added to the client by device's other user name (except admin), if **Double Verification** is enabled on this NVR, when playing back videos on the client, you are required to enter the user name and password created for double verification. For details about double verification, refer to the user manual of the NVR.
- 

### 6.13.1 Download Video Footage by Date

During playback, you can download the video footage of the camera and save in the local PC.

#### Steps

1. Enter Remote Playback page and select a camera to start playback.

---

### **Note**

For details about starting playback, refer to ***Remote Playback*** .

---

2. Right click on the image and click **Download**.
3. Set the start and end time of the video footage to download.
4. Enter a name for the video footage.
5. Click **OK** to start downloading the video footage to the local PC.

### **6.13.2 Download for Multiple Cameras**

During the playback of multiple cameras, you can download the video files of multiple cameras by date simultaneously.

#### **Steps**

1. Enter Remote Playback page and select multiple cameras to start playback.
- 

### **Note**

For details about starting playback, refer to ***Remote Playback*** .

---

2. Click  to open the Download for Multiple Cameras window.  
All the cameras in playback will be displayed.
  3. Select the cameras you want to download video files for.
  4. Set the start time and end time of video duration for each camera.
  5. **Optional:** Check **Download Player** to download the player.
  6. Click **Download** to start downloading the video files of the configured duration(s) to the local PC.  
The progress bar shows the downloading process of each camera's video files.
  7. **Optional:** Click **Stop** to stop downloading manually.
- 

### **Note**

Up to 16 cameras' video files can be downloaded simultaneously.

---



## Chapter 7 Event Configuration

Event is used to notify security personnel of the particular situation which helps handle the situation promptly. Event can trigger a series of linkage actions (e.g., audible warning and sending email ) for notification and event handling. You can enable the event and set linkage action(s) for the resources added to the client. If the selected events happen, the client will receive event notifications in real-time and you can check the details and handle the events accordingly.

### Video Event

The video events refer to the special events triggered by video exception, monitoring area's exception, alarm input, encoding device's exception, etc. For more details, refer to **Configure Event for Camera** , **Configure Event for Alarm Input** , and **Configure Event for Encoding Device** .

### Access Control Event

The access control events refer to the special events triggered at the access control devices, doors, card readers, elevators, video intercom devices, etc. For more details, refer to **Configure Client Actions for Access Event** and **Configure Video Intercom Event** .

### Security Control Event

The security control events refer to the special events triggered by the zones of the security control panels. For more details, refer to **Configure Client Linkage for Zone Event** .

## 7.1 Configure Event for Camera

The event for camera refers to the video exception or the events detected in the monitoring area of the camera, such as motion detection, video loss, line crossing, and so on. You can enable an event for the cameras in the client. When the event is triggered on the camera, the client can receive and record event for checking and trigger a series of linkage actions (e.g., sending email) for notification.

### Steps

1. Click **Event Configuration** → **Video Event** → **Camera** .

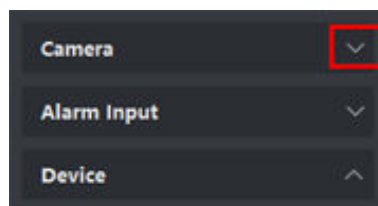

Figure 7-1 Display Camera Resource

2. Unfold the group and select a camera as event source.

 **Note**

Make sure the resource is online.

All the event types supported by the selected camera will appear.

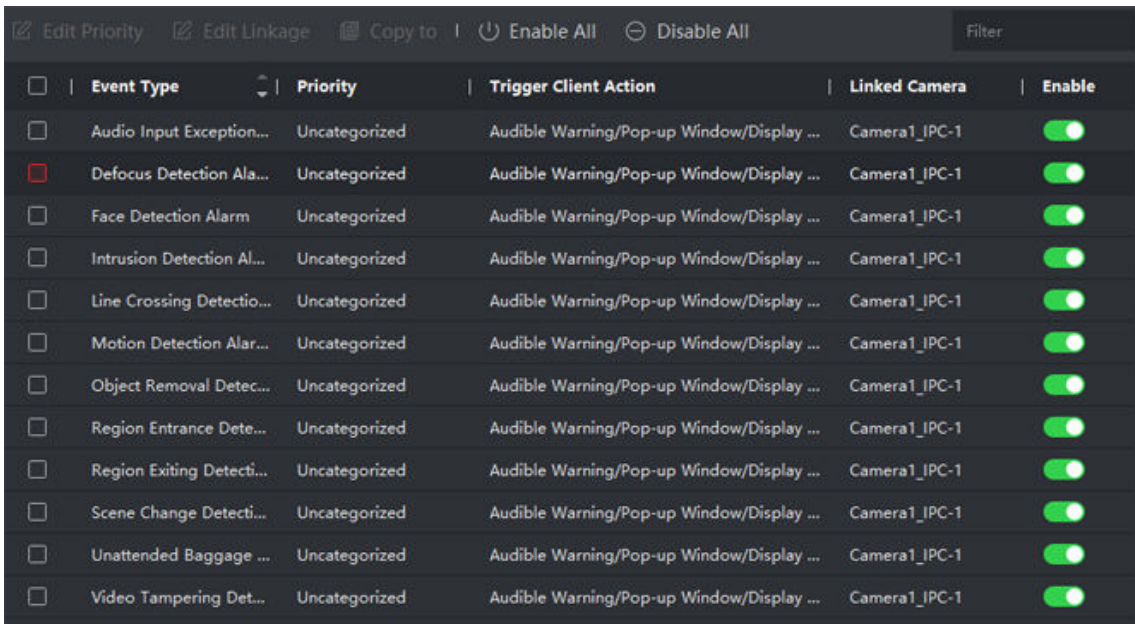

Event Type	Priority	Trigger Client Action	Linked Camera	Enable
Audio Input Exception...	Uncategorized	Audible Warning/Pop-up Window/Display ...	Camera1_IPC-1	<input checked="" type="checkbox"/>
Defocus Detection Ala...	Uncategorized	Audible Warning/Pop-up Window/Display ...	Camera1_IPC-1	<input checked="" type="checkbox"/>
Face Detection Alarm	Uncategorized	Audible Warning/Pop-up Window/Display ...	Camera1_IPC-1	<input checked="" type="checkbox"/>
Intrusion Detection Al...	Uncategorized	Audible Warning/Pop-up Window/Display ...	Camera1_IPC-1	<input checked="" type="checkbox"/>
Line Crossing Detectio...	Uncategorized	Audible Warning/Pop-up Window/Display ...	Camera1_IPC-1	<input checked="" type="checkbox"/>
Motion Detection Alar...	Uncategorized	Audible Warning/Pop-up Window/Display ...	Camera1_IPC-1	<input checked="" type="checkbox"/>
Object Removal Detec...	Uncategorized	Audible Warning/Pop-up Window/Display ...	Camera1_IPC-1	<input checked="" type="checkbox"/>
Region Entrance Dete...	Uncategorized	Audible Warning/Pop-up Window/Display ...	Camera1_IPC-1	<input checked="" type="checkbox"/>
Region Exiting Detecti...	Uncategorized	Audible Warning/Pop-up Window/Display ...	Camera1_IPC-1	<input checked="" type="checkbox"/>
Scene Change Detecti...	Uncategorized	Audible Warning/Pop-up Window/Display ...	Camera1_IPC-1	<input checked="" type="checkbox"/>
Unattended Baggage ...	Uncategorized	Audible Warning/Pop-up Window/Display ...	Camera1_IPC-1	<input checked="" type="checkbox"/>
Video Tampering Det...	Uncategorized	Audible Warning/Pop-up Window/Display ...	Camera1_IPC-1	<input checked="" type="checkbox"/>

**Figure 7-2 Configure Events for Camera**

**3. Optional:** Enter keywords in **Filter** field to locate the desired event quickly.

**4. Optional:** Turn on the switch on the Enable column to enable the event type, or click **Enable All** to enable all the event types of this camera.

 **Note**

After enabled, the event can be received by the client and trigger the linkage action(s). You can also disable an event type or disable all event types.

**5. Optional:** Select the event(s), and then perform the following operations.

**Edit Priority** Click **Edit Priority** to set the priority of the event(s).

**Priority** Priority represents the emergency degree of the event.

**Edit Event Linkage** Click **Edit Event Linkage** to set the linkage action(s) of the event(s).

**Audible Warning**

Trigger the client's audible warning when the event is triggered.

You can select the audio file on the drop-down list, or click **Add** to add new audio file (in WAV format).

You can click  to make an audition of the selected audio file.

**Send Email**

Send an email notification of the alarm information to one or more receivers.

For details about setting email parameters, refer to [\*\*\*Set Email Parameters\*\*\*](#) .

### Pop-up Window

Pop-up window to display the event related information (including event details, live video of the source camera, captured pictures of the linked camera) on the client when the event is triggered. You can also enter remarks about how to handle the event.

### Display on Map

When the event source is added as a hot spot on the map, the hot spot will be displayed with  twinkling aside when the event is triggered, which helps security personnel view the location of the event.

You can also click the hot spot to view the event details and the live video of the linked camera.

### Linked Camera

Link the selected camera to capture picture or record video when the event is triggered.



Up to 4 cameras can be selected.

---

### Copy Event Settings

Click **Copy to** to copy the event settings of this camera to other camera(s).

---



You can only copy the event settings to the resource(s) of the same type.

---

### What to do next

You need to arm the device which the camera belongs to, otherwise the client cannot receive the configured events. For details, see [\*\*\*Enable Receiving Event from Devices\*\*\*](#) .

## 7.2 Configure Event for Alarm Input

The event for alarm input refers to the event triggered by alarm input. You can enable an event for the alarm inputs in the client. When the alarm input is triggered, the client can receive and record event for checking and trigger a series of linkage actions (e.g., sending email) for notification.

### Steps

1. Click **Event Configuration** → **Video Event** → **Alarm Input** .

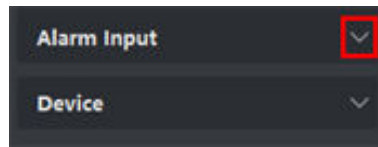

**Figure 7-3 Display Alarm Input Resource**

2. Unfold the group and select an alarm input as event source.

---

 **Note**

Make sure the resource is online.

---

All the event types supported by the selected alarm input will appear.

3. **Optional:** Enter keywords in **Filter** field to locate the desired event quickly.
4. **Optional:** Turn on the switch on the Enable column to enable the event type, or click **Enable All** to enable all the event types of this alarm input.

---

 **Note**

After enabled, the event can be received by the client and trigger the linkage action(s). You can also disable an event type or disable all event types.

---

5. **Optional:** Select the event(s), and then perform the following operations.

**Edit** Click **Edit Priority** to set the priority of the event(s).

**Priority** Priority represents the emergency degree of the event.

**Edit Event Linkage** Click **Edit Event Linkage** to set the linkage action(s) of the event(s).

**Audible Warning**

Trigger the client's audible warning when the event is triggered.

You can select the audio file on the drop-down list, or click **Add** to add new audio file (in WAV format).

You can click  to make an audition of the selected audio file.

**Send Email**

Send an email notification of the alarm information to one or more receivers.

For details about setting email parameters, refer to **Set Email Parameters**.

**Pop-up Window**

Pop-up window to display the event related information (including event details, live video of the source camera, captured pictures of the linked camera) on the client when the event is triggered. You can also enter remarks about how to handle the event.

**Display on Map**

When the event source is added as a hot spot on the map, the hot spot will be displayed with 🔔 twinkling aside when the event is triggered, which helps security personnel view the location of the event.

You can also click the hot spot to view the event details and the live video of the linked camera.

### Linked Camera

Link the selected camera to capture picture or record video when the event is triggered.

---

#### Note

Up to 4 cameras can be selected.

---

**Copy Event Settings** Click **Copy to** to copy the event settings of this alarm input to other alarm input(s).

---

#### Note

You can only copy the event settings to the resource(s) of the same type.

---

### What to do next

You need to arm the device which the alarm input belongs to, otherwise the client cannot receive the configured events. For details, see [\*\*\*Enable Receiving Event from Devices\*\*\*](#) .

## 7.3 Configure Event for Encoding Device

The event for encoding device refers to encoding device's exception, such as device offline. You can enable an event for the encoding devices added in the client. When the event is triggered on the device, the client can receive and record event for checking and trigger a series of linkage actions (e.g., sending email) for notification.

### Steps

1. Click **Event Configuration** → **Video Event** → **Device** .

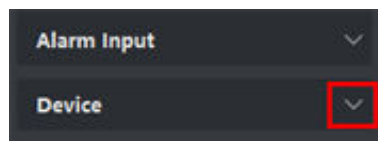

Figure 7-4 Display Device Resource

2. Select a device as event source.

---

#### Note

Make sure the resource is online.

---

All the event types supported by the selected device will appear.

- 3. Optional:** Enter keywords in **Filter** field to locate the desired event quickly.
- 4. Optional:** Turn on the switch on the Enable column to enable the event type, or click **Enable All** to enable all the event types of this device.

---

### **Note**

After enabled, the event can be received by the client and trigger the linkage action(s). You can also disable an event type or disable all event types.

- 5. Optional:** Select the event(s), and then perform the following operations.

**Edit** Click **Edit Priority** to set the priority of the event(s).

**Priority** Priority represents the emergency degree of the event.

**Edit Event** Click **Edit Event Linkage** to set the linkage action(s) of the event(s).

**Linkage** **Audible Warning**

Trigger the client's audible warning when the event is triggered.

You can select the audio file on the drop-down list, or click **Add** to add new audio file (in WAV format).

You can click  to make an audition of the selected audio file.

#### **Send Email**

Send an email notification of the alarm information to one or more receivers.

For details about setting email parameters, refer to ***Set Email Parameters***.

**Copy Event** Click **Copy to** to copy the event settings of this device to other device(s).  
**Settings**

---

### **Note**

You can only copy the event settings to the resource(s) of the same type.

---

### **What to do next**

You need to arm this device, otherwise the client cannot receive the configured events. For details, see ***Enable Receiving Event from Devices***.

## Chapter 8 Event Center

The event information (for example, device offline) received by the client displays. In the Event Center, you can check the detailed information of the real-time and historical events, view the event linked video, handle the events, and so on.

Before the client can receive the event information from the device, you need to enable the events of the resource and arm the device first. For details, refer to [\*\*Event Configuration\*\*](#) and [\*\*Enable Receiving Event from Devices\*\*](#).

Before the you can view the pop-up alarm information, you need to enable event triggered pop-up image in the event center. For details, refer to [\*\*View Pop-up Event Information\*\*](#).

### 8.1 Enable Receiving Event from Devices

Before the client software can receive event notifications from the device, you need to arm the device first.

#### Steps

1. Click  → **Tool** → **Device Arming Control** to open Device Arming Control page.

All the added devices appear on this page.

2. **Optional:** If there are too many devices, enter the key words in Filter field to filter the device(s) you want.



#### Note

For the filtered devices, you can click **Arm All** or **Disarm All** to enable receiving event of these devices.

3. In the Auto-Arming column, turn on the switch to enable auto-arming.

---

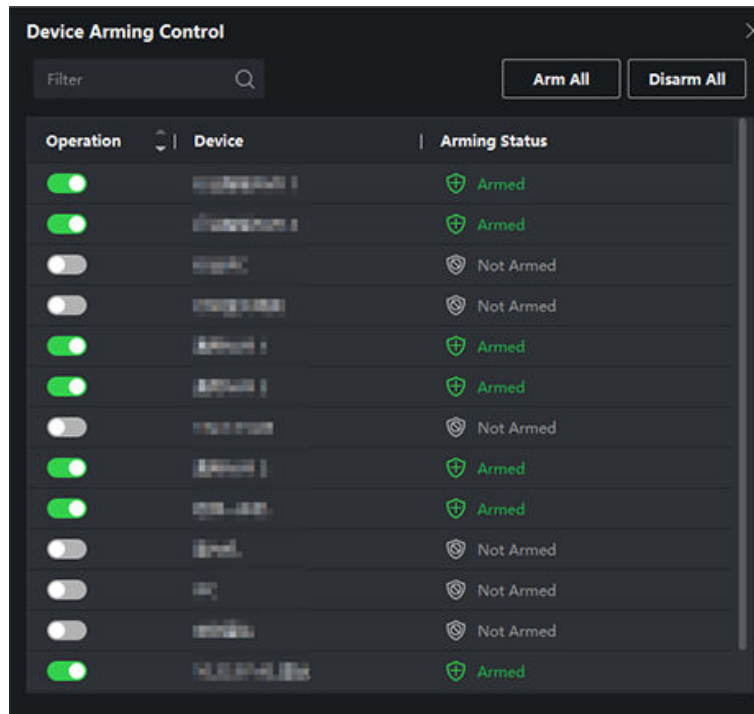

**Figure 8-1 Arm Device**

After turned on, the device(s) will be armed. And notifications about the events triggered by the armed device(s) will be automatically sent to the client software in real-time.

## 8.2 View Real-Time Events

The real-time event information received by the client of the connected resources are displayed. You can check the real-time event information, including event source, event time, priority, etc.

### Before You Start

Enable receiving events from devices before the client can receive event from the device, see [Enable Receiving Event from Devices](#) for details.

### Steps

1. Click **Event Center** → **Real-time Event** to enter the real-time event page and you can view the real-time events received by the client.

#### Event Time

For encoding device, event time is the client time when it receives the event. For other device types, event time is the time when the event is triggered.

#### Priority

Priority represents the emergency degree of the event.

2. Filter the events.



**Filter by Device Type and (or) Priority** Select device type(s) and (or) priorities to filter events.

**Filter by Keywords** Enter the keywords to filter the events.

3. **Optional:** Right-click the table header of the event list to customize the event related items to be displayed in the event list.

4. Select an event in the event list to view the event details.

---

 **Note**

When **Save Pictures in Structure Data Format** is enabled, no pictures will be displayed in Event Details in Event Center. For details about **Save Pictures in Structure Data Format**, refer to **Set General Parameters**.

---

 **Note**

- The event details include the captured picture(s), video (recorded video triggered by the event or live view of the device), and other event descriptions.
  - To view the recorded video triggered by the event, you should link camera(s) with the device in event configuration. For details, refer to **Event Configuration**.
  - To view the captured picture(s), you need to configure picture storage in storage schedule.
- 

5. **Optional:** Perform the following operations if necessary.

**Handle Single Event** Click **Handle** to enter the processing suggestion, and then click **OK**.

---

 **Note**

After an event is handled, the **Handle** button will become **Add Remark**. Click **Add Remark** to add more remarks for this handled event.

---

**Handle Events in a Batch** Select events that need to be processed, and then click **Handle in Batch**. Enter the processing suggestion, and then click **OK**.

**Enable/Disable Alarm Audio** Click **Audio On/Mute** to enable/disable the audio of the event.

**Select the Latest Event Automatically** Check **Auto-Select Latest Event** to select the latest event automatically and the event information details is displayed.

**Clear Events** Click **Clear** to clear the all the events in the event list.



**Send Email** Select an event and then click **Send Email**, and the information details of this event will be sent by email.

---

 **Note**

You should configure the email parameters first, see **Set Email Parameters** for details.

---

<b>Auto-Play Video</b>	Check <b>Auto-Play Video</b> to automatically play video when displaying event details.
<b>Enlarge Video or Picture</b>	<ul style="list-style-type: none"><li>• Double click the video image to view video in a larger window.</li><li>• Put the cursor on the picture, and click  to view picture in a larger window.</li></ul>
<b>Download Captured Picture</b>	Hover the cursor on the captured picture, and click the download icon on the lower right corner of the picture to download it to the local PC.
<b>Download Event Triggered Video</b>	Hover the cursor on the recorded video, click  to download the video (30s before the event happens) triggered by the event.

## 8.3 Search Historical Events

You can search and view historical events by setting search conditions such as time, device type, and priority in the client. For the searched events, you can handle and export them.

### Before You Start

Enable receiving events from devices before the client can receive event information from the device, see [Enable Receiving Event from Devices](#) for details.

### Steps

1. Click **Event Center** → **Event Search** to enter the event search page.
2. Set the filter conditions to display the required events only.

#### Time

The time when the event starts.

#### Search by

##### Device

Search the events by device or the device's resource channels. If searched by device, you need to set the followings:

- **Include Sub-Node:** Search the events of the device and all resource channels.
- **Device Type:** Select the device from which you want to search events.

##### Group

Search the events by resource channels in the group.

---

#### Note

- For video intercom device, you need to select search scope: All and Locking Log.
  - For access control device, you can click **Show More** to set more conditions: status, event type, card reader type, person name, card No., and organization.
- 

#### Priority

The priority including low, medium, high and uncategorized which indicates the emergency degree of the event.

## Event Type

Select one or more event types to be searched from the drop-down list.



### Note

You can enter a key word (supports fuzzy search) in the search box to search the target event type(s).

## Status

The handling status of the event.

## Search by Keyword

Enter a key word (supports fuzzy search) to quickly search the target historical event(s). For example, you can enter a person's name to search the events related with this person.

3. Click **Search** to search the events according the conditions you set.



### Note

When **Save Pictures in Structure Data Format** is enabled, no pictures will be displayed in Event Details field in Event Center. For details about **Save Pictures in Structure Data Format**, refer to **Set General Parameters**.

<input type="checkbox"/>	Index	Device Name	Event Type	Event Time	Device Type	Group Name	Object Name	Object Type	Priority	Event Details
<input type="checkbox"/>	4	101	Smoke Detection Alarm	2020-03-13 19:03:04	Encoding D...	FS	Camera 1	Camera	Uncategorized	Linked Camera: Camera 1
<input type="checkbox"/>	5	101	Detector Work Status	2020-03-13 19:02:54	Encoding D...	FS	Camera 1	Camera	Uncategorized	Linked Camera: Camera 1
<input type="checkbox"/>	6	101	Detector Work Status	2020-03-13 19:02:44	Encoding D...	FS	Camera 1	Camera	Uncategorized	Linked Camera: Camera 1
<input type="checkbox"/>	7	101	Detector Work Status	2020-03-13 19:02:34	Encoding D...	FS	Camera 1	Camera	Uncategorized	Linked Camera: Camera 1
<input type="checkbox"/>	8	101	Detector Work Status	2020-03-13 19:02:34	Encoding D...	FS	Camera 1	Camera	Uncategorized	Linked Camera: Camera 1
<input type="checkbox"/>	9	101	Detector Work Status	2020-03-13 19:02:34	Encoding D...	FS	Camera 1	Camera	Uncategorized	Linked Camera: Camera 1
<input type="checkbox"/>	10	101	Detector Work Status	2020-03-13 19:02:20	Encoding D...	FS	Camera 1	Camera	Uncategorized	Linked Camera: Camera 1

Total 364 Record(s) 50 / 8 Page(s)

Event Details:

Picture: No picture

Handling records: No handling record.

Figure 8-2 Search Historical Events

4. **Optional:** Right click the table header of the event list to customize the event related items to be displayed in the event list.

## 5. Select an event in the event list to view the event details.

---

### **Note**

- The event details include the captured picture(s), video (recorded video triggered by the event or live view of the device), and other event descriptions.
  - To view the recorded video triggered by the event, you should link camera(s) with the device in event configuration. For details, refer to ***Event Configuration***.
  - To view the captured picture(s), you need to configure picture storage in storage schedule.
- 

## 6. **Optional:** Perform one of the following operations.

### **Handle Single Event**

Handle single event: Select one event that needs to be handled, and then click **Handle** in the event information details page, and enter the handling suggestion.

---

### **Note**

After an event is handled, the **Handle** button will become **Add Remark**, click **Add Remark** to add more remarks for this handled event.

---

### **Batch Handle Events**

Handle events in a batch: Select the events which need to be handled, and then click **Handle in Batch**, and enter the handling suggestion.

---

### **Note**

After an event is handled, the **Handle** button will become **Add Remark**, click **Add Remark** to add more remarks for this handled event.

---

### **Auto-Play Video**

Check **Auto-Play Video** to automatically play video when displaying event details.

### **Enlarge Video or Picture**

- Double click the video image to view video in a larger window.
- Put the cursor on the picture, and click  to view picture in a larger window.

### **Send Email**

Select an event and then click **Send Email**, and the information details of this event will be sent by email.

---

### **Note**

You should configure the email parameters first, see ***Set Email Parameters*** for details.

---

### **Export Event Information**

Click **Export** to export the event log or event pictures to the local PC in CSV/Excel file. You can set the saving path manually.

### **Download Captured Picture**

Hover the cursor on the captured picture, and click the download icon on the lower right corner of the picture to download it to the local PC.

---

**Download Event Triggered Video** Hover the cursor on the recorded video, click  to download the video (30s before the event happens) triggered by the event.

## 8.4 Get Events from Device

For some scenarios (e.g., the client cannot start up, access control device has been armed by other client, etc.), the events received by the client and triggered on access control device are not consistent. You can get events from device remotely to synchronize the events from device to Event Center of the client.

Click **Device Management** → **Device** → **Device** , select access control device(s), and click **Get Events from Device**.

Synchronize the events by the two ways:

- **Online:** When the device is online and the device can communicate with client at real time, you can select **Online** and set the start time and end time to get the events during this period.
- **Import File:** If the network is not good or the device cannot communicate with the client at real time, you can export the event file from the selected device firstly, and import this exported file on the client later by selecting **Import File** and entering the password of the encrypted file.

### Note

- For data security, you should encrypt the file when exporting on the device. Meanwhile, the selected access control device should be the one you exported the file from.
- The function should be supported by the device.

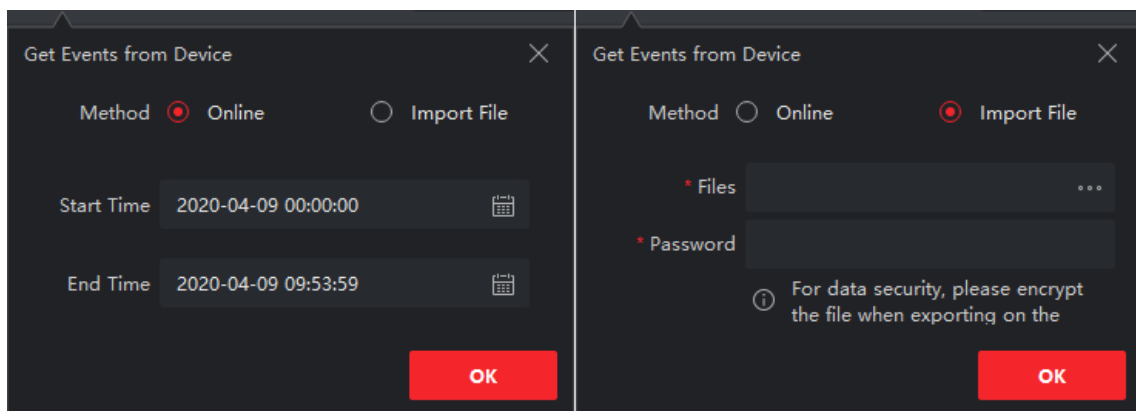

Figure 8-3 Get Events from Device

### Note

If you want to get the events related with attendance only, you can also enter **Time & Attendance** → **Attendance Statistics** → **Attendance Records** , click **Get Events from Device** and select **Online** or **Import File** to get the events.

## 8.5 View Pop-up Event Information

If you have enabled event notification and set Event Triggered Pop-up Image as its linkage action, a window will pop up when the event happens, showing the event information, related pictures, and related videos.

Go to **Event Center** → **Real-Time Event** , and then click **Enable Alarm Triggered Pop-up Image** to enable the function.

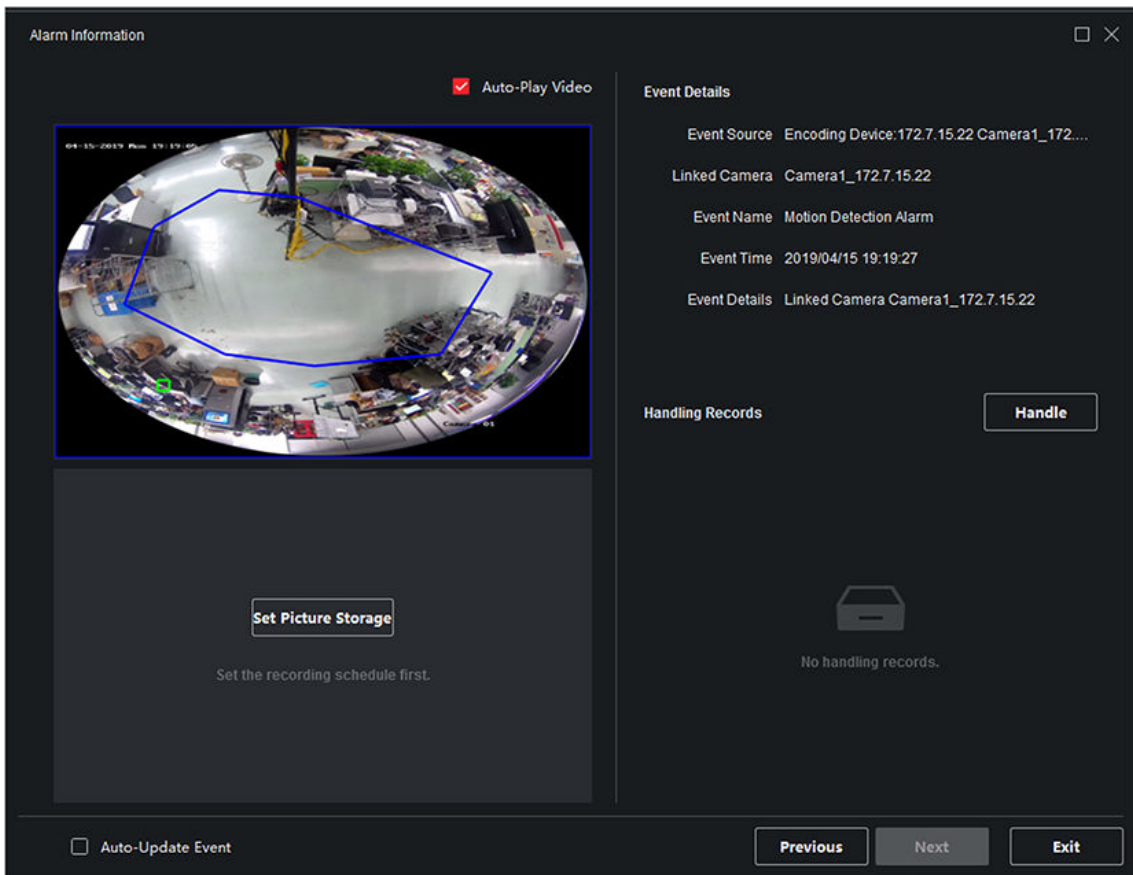

**Figure 8-4 The Pop-up Event Information**

You can view the event related video footage (from 30 s before the event to the end of the event), the picture captured when the event happens, as well as the event details such as event source, linked camera, event type, etc.

---

 **Note**

- When the window is not closed, you should click **Next** to view the new event information if a new event is triggered.
  - If you haven't clear the event information, you can click **Previous** to view the previous event information.
  - When **Save Pictures in Structure Data Format** is enabled, pictures will not be displayed in the event information. See ***Set General Parameters*** for more details.
- 

You can check **Auto-Update Event** to enable the window to automatically switch to the latest event information when a new event is triggered.

## Chapter 9 Map Management

The E-map function gives a visual overview of the locations and distributions of the installed cameras and alarm input devices. You can get the live view of the cameras on the map, and you will get a notification message from the map when alarm is triggered.

E-map is a static image (it do not have to be geographical maps, although they often are. Depending on your organization's needs, photos and other kinds of image files can also be used as e-maps) which gives you a visual overview of the locations and distributions of the hot spots (resources (e.g., camera, alarm input) placed on the map are called hot spots). You can see the physical locations of the cameras and alarm inputs, and in what direction the cameras are pointing. With the function of hot region, e-maps can be organized into hierarchies to navigate from large perspectives to detailed perspectives, e.g., from floor level to room level.

### 9.1 Add Map

You should add a map as the parent map for the hot spots and hot regions.

#### Steps

---

#### Note

Only one map can be added to one group.

---

1. Open the E-map page.
2. Select a group for which you want to add a map.

---

#### Note

For details about setting the group, refer to [Group Management](#) .

---

3. Click **Add Map** to open the map adding window.
4. Enter a descriptive name of the added map.
5. Select a map picture from the local path.

---

#### Note

The picture format of the map can only be PNG, JPEG or BMP.

---

6. Click **OK**.
7. **Optional:** Perform the following tasks after adding the map.

<b>Zoom in/out</b>	Use the mouse wheel or click + or - to zoom in or zoom out on the map.
<b>Adjust Map Area</b>	Drag the yellow window in the lower-right corner or use the direction buttons and zoom bar to adjust the map area for view.



## 9.2 Edit Map Scale

The scale of a map is the ratio of a distance on the map to the corresponding distance on the ground. The client can calculate two locations' distance on the map according to the distance on the ground. An accurate map scale is essential for defining radar's monitoring range.

### Before You Start

Make sure you have added a map. See [Add Map](#) for details.

Perform this task if you need to add a security radar to the map.

### Steps

1. Enter the E-map module.
2. Click **Edit** on the E-map toolbar to enter the map editing mode.
3. Click **Map Calibration** → **Edit Scale** to select two locations on the map.

The cursor will turn to  if you hover it on the map.

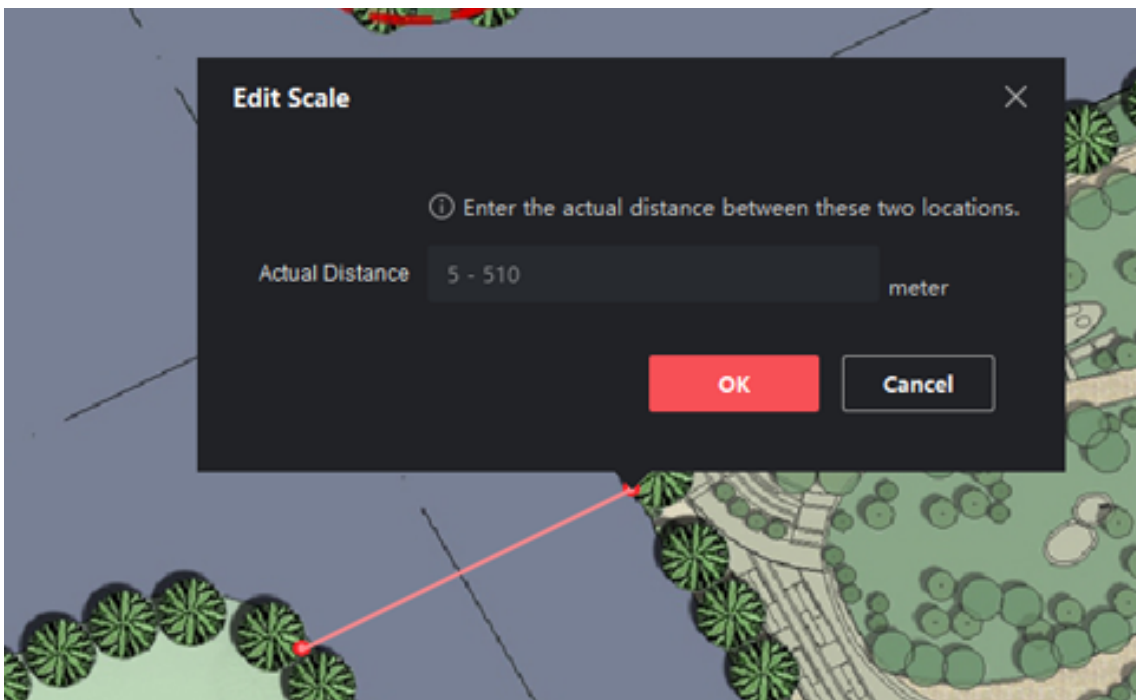

Figure 9-1 Edit Map Scale

4. Click on the map to select two locations.  
The Edit Scale window pops up.
5. Enter the ground distance between the two locations, and then click **OK**.  
The client will calculate the map scale automatically.

## 9.3 Longitude and Latitude Calibration

After calibrating the longitude and latitude of two points on the E-map, you can drag the added radar in the group to the E-map. The radar will automatically move to the correct position on the E-map according to the longitude and latitude of two points calibration.

### Before You Start

1. Make sure you have added radar on the Client.
  2. Make sure you have set the longitude and latitude parameters of the radar by web browser.
- Enter the context of your task here (optional).

### Steps

1. Enter the E-map module.
2. Click **Edit** on the E-map toolbar to enter the map editing mode.
3. Click **Map Calibration → LongitudeLatitude Calibration** .
4. Click **Add Calibration Point**.
5. Click a point on the map, enter the longitude and latitude of the point in the pop-up window, click **Save**.
6. Click **Add Calibration Point** and repeat the previous step to add the second calibration point.
7. Drag the radar in the left resources group to the map.  
The radar will automatically move to the correct position on the map according to the longitude and latitude of two points calibration.

## 9.4 Manage Hot Spot

The devices added to the map are called hot spots. The hot spots show the locations of the devices, and you can also get the live view or alarm information of the surveillance scenarios through the hot spots.

### 9.4.1 Add Camera as Hot Spot

You can add cameras to the map as hot spots.

#### Before You Start

Make sure you have added an e-map and a camera to the client. See [Add Map](#) and [Device Management](#) for details.

#### Steps

1. Enter the E-map page.
2. Click **Edit** in the upper-right corner to enter the map editing mode.
3. Click **Add Hot Spot → Camera Hot Spot** to open the Add Hot Spot window.

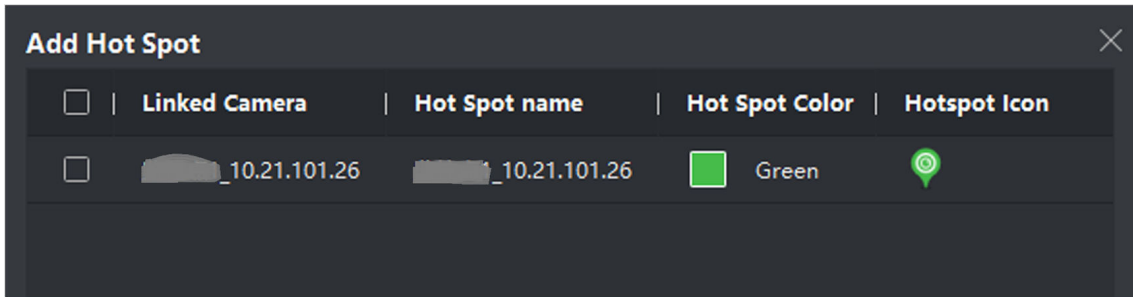

Figure 9-2 Add Hot Spot Panel

4. Select the cameras to be added to the map.
5. **Optional:** Edit the hot spot name, select the name color and select the hot spot icon.
6. Click **OK** to save the settings.

 **Note**

You can also drag the camera icons from the group list to the map directly to add the hot spots.

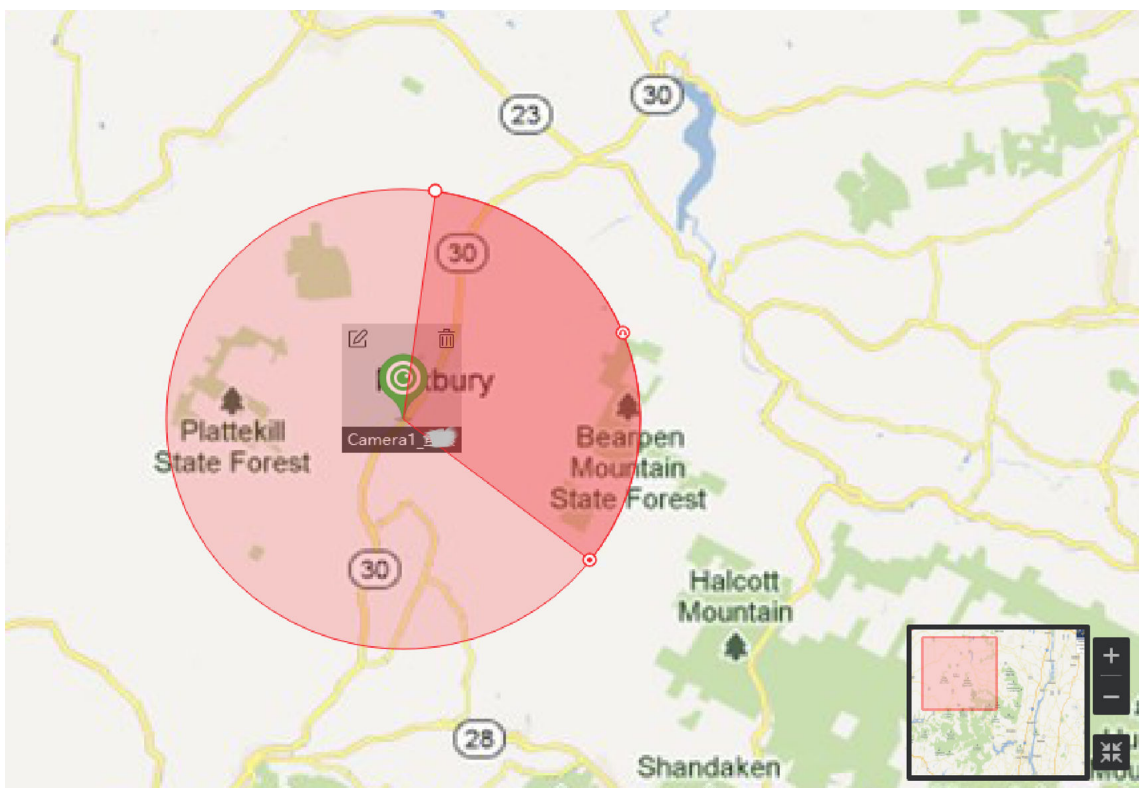







Figure 9-3 Camera on the Map

The camera icons are added on the map as hot spots and the icons of the added cameras in the group list change from  to . The sector indicates the camera's field of view.

7. Perform the following operation(s).

- Move the Hot Spot** Drag the hot spot to move it to a certain position.
- Change the FOV Angle** Drag  /  and revolve to change the camera's field of view.
- Change the FOV Size** Drag  to change the FOV size.

### 9.4.2 Add Alarm Input as Hot Spot

You can add the alarm inputs to the map as hot spots.

#### Steps

1. Enter the E-map module.
2. Click **Edit** in the upper-right corner to enter the map editing mode.
3. Click **Add Hot Spot** → **Alarm Input Hot Spot** to open the Add Hot Spot window.
4. Select the alarm inputs to be added to the map.
5. **Optional:** Edit hot spot name, select the name color and select the hot spot icon by double-clicking the corresponding field.
6. Click **OK**.

---

#### **Note**

You can also drag the alarm input icons from the group list to the map directly to add the hot spot.

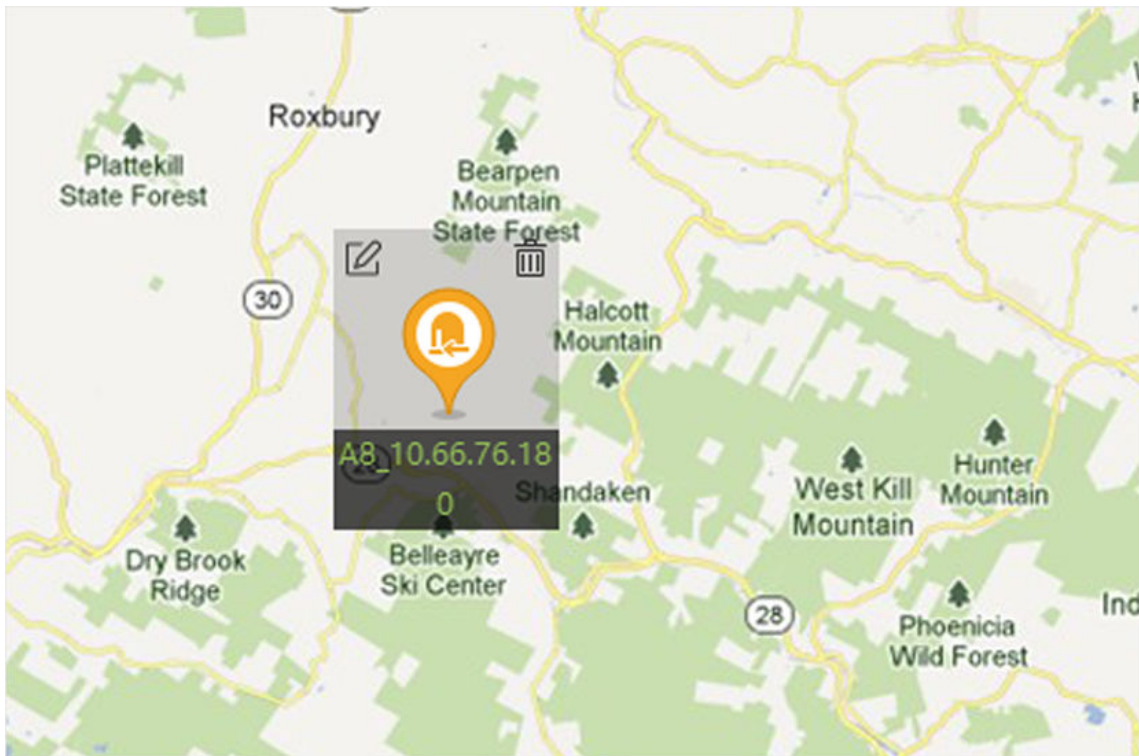



Figure 9-4 Alarm Input on the Map

---

The alarm input icons are added to the map as hot spots and the icons of the added alarm inputs in the group list change from  to .

**7. Optional:** Drag the hot spot to move it to a certain position.

### 9.4.3 Add Alarm Output as Hot Spot

You can add alarm outputs to the map as hot spots for management. After that, you can enable or disable it in a quick manner. If you enable an alarm output on the map, the security control devices (e.g. sirens, bells) connected to it will alarm for attention.

#### Before You Start

Make sure you have added an e-map and alarm output to the client. See [Add Map](#) and [Device Management](#) for details.

#### Steps

1. Enter the E-map module.
2. Click **Edit** on the E-map toolbar to enter the map editing mode.
3. Click **Add Hot Spot** → **Alarm Output Hot Spot** to open the Add Hot Spot panel.

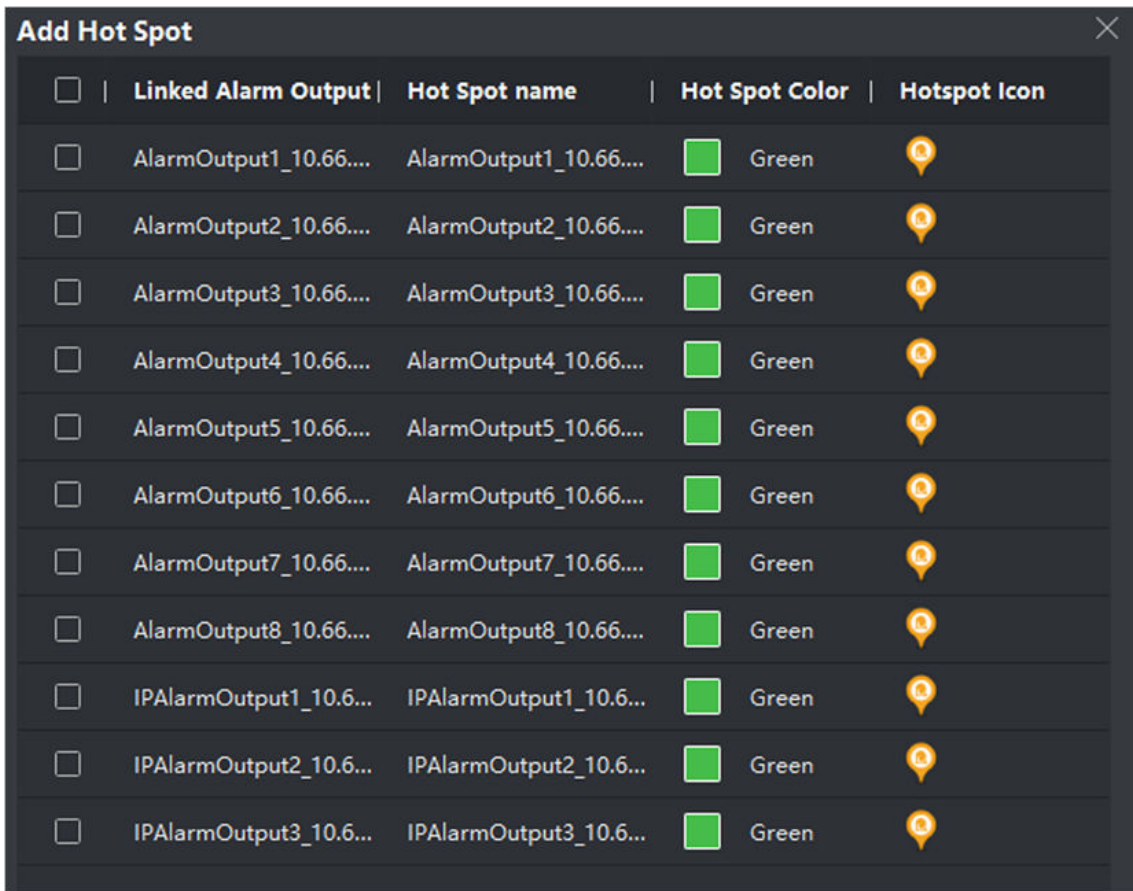

Figure 9-5 Add Hot Spot Panel

4. Select the alarm output to be added to the map.
5. **Optional:** Edit the hot spot name, select the name color, and select the hot spot icon.
6. Click **OK**.

---

**Note**

You can also drag an alarm output icon from the alarm output list to the map to add the hot spot.



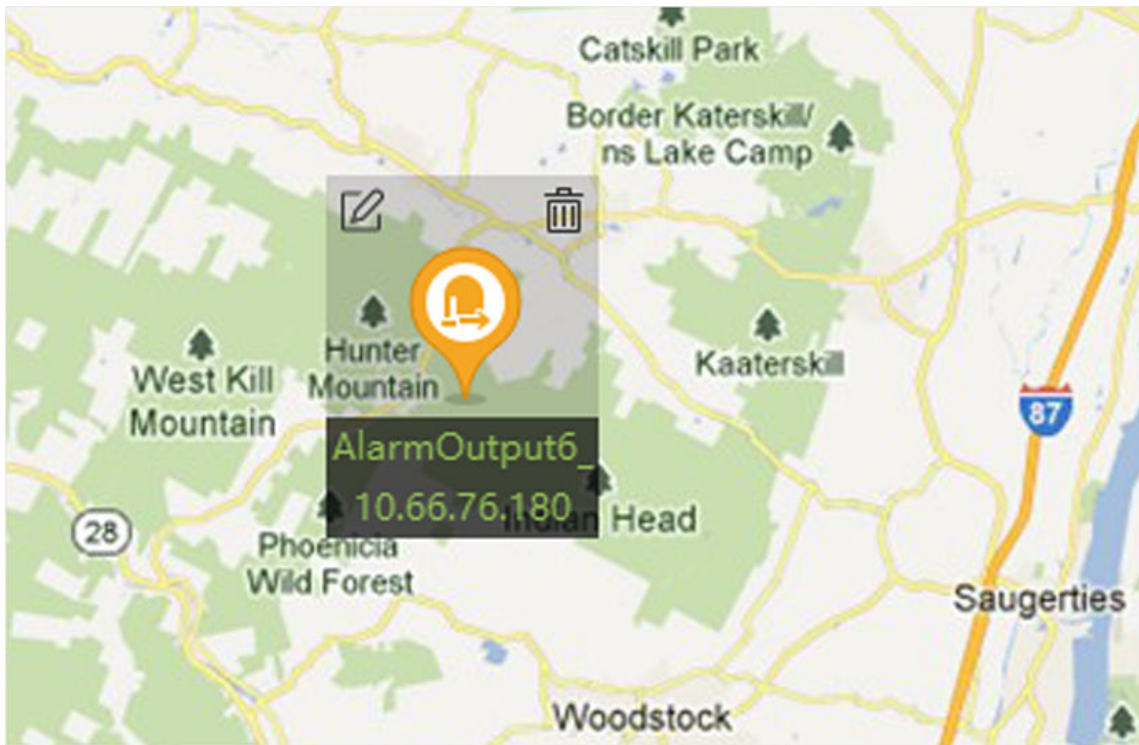



Figure 9-6 Alarm Output on the Map

---

The alarm output is added to the map as a hot spot and its icon in the group list changes from  to .

7. **Optional:** Drag the alarm output to move it to a certain position.

#### 9.4.4 Add Zone as Hot Spot

You can add zones to the map so that you can quickly locate the zone when an alarm is triggered.

##### Before You Start

Make sure you have added a map and zone to the client. See [Add Map](#) and [Add Device](#) for details.

##### Steps

1. Enter the E-map module.
2. Click **Edit** on the E-map toolbar to enter the map editing mode.
3. Click **Add Hot Spot** → **Zone Hot Spot** to open the Add Hot Spot panel.

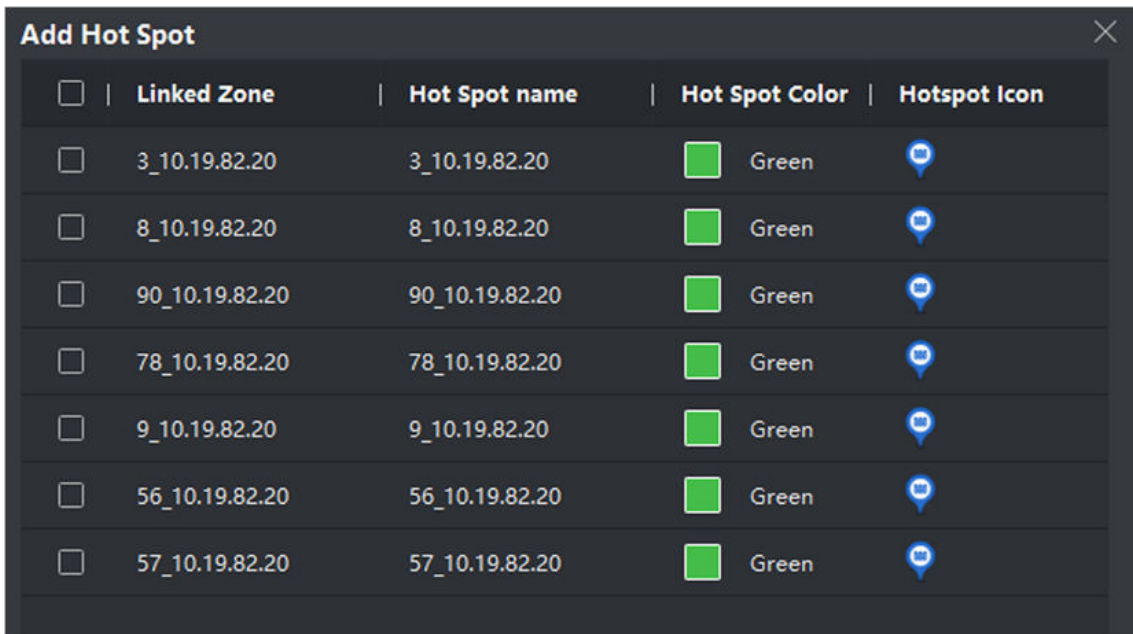

Figure 9-7 Add Hot Spot Panel

4. Select the zone(s) to be added to the map.
5. **Optional:** Edit the hot spot name, select the name color, and select the hot spot icon.
6. Click **OK**.



#### Note

You can also drag the alarm output icons from the alarm output list to the map to add the hot spot.



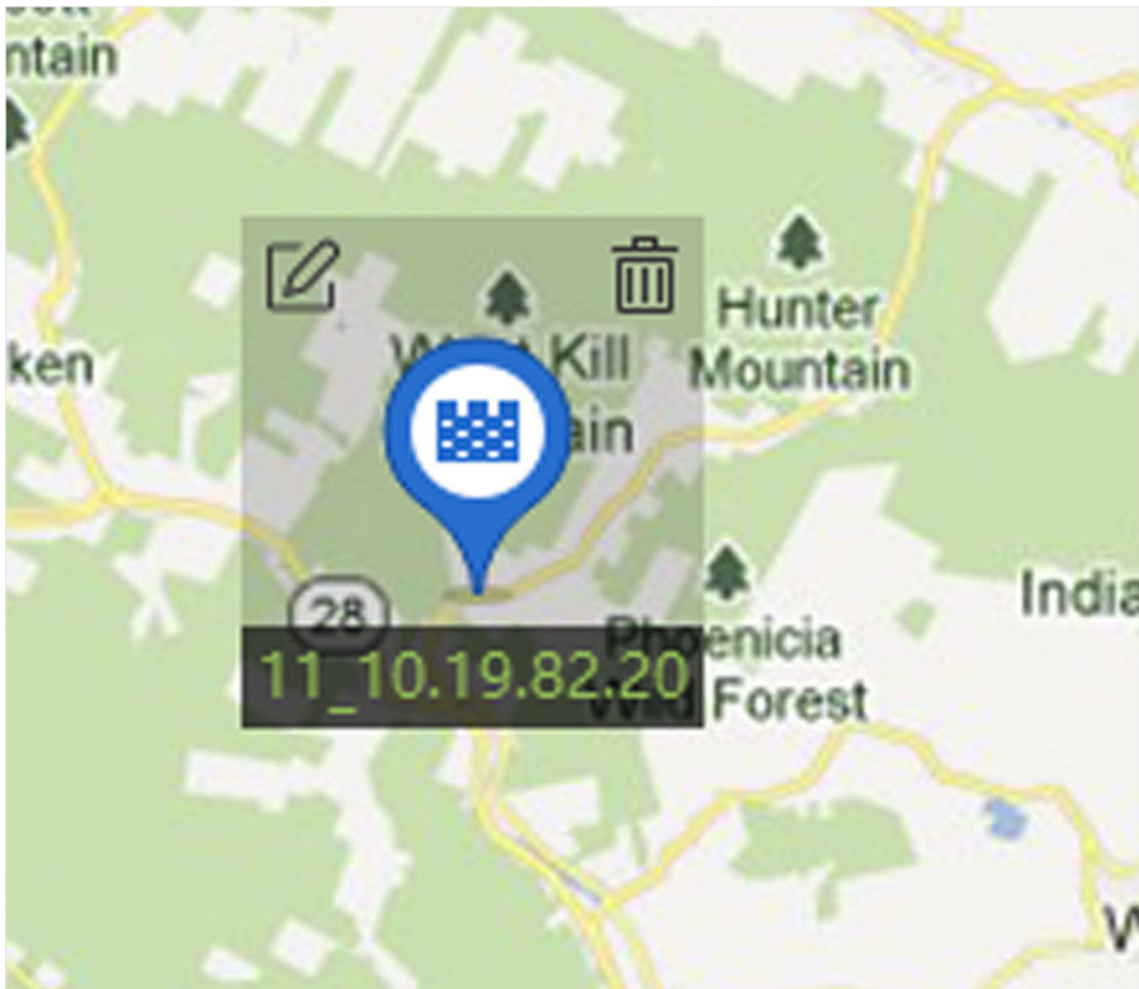



Figure 9-8 Zone on the Map

---

The zone is added to the map as a hot spot and its icon in the group list changes from  to .

**7. Optional:** Drag the zone hot spot to move it to a certain position.

When alarms are triggered, the number of the newest alarms will be displayed on the zone's icon. You can click the number to see the alarms details.

---

 **Note**

No more than 10 newest alarms can be displayed.

**8. Optional:** Click **Clear Alarms** to mark the alarms of the zones on the current map as read.

### 9.4.5 Add Access Point as Hot Spot

You can add access points to the map as hot spots, so that you can find the hot spots and view their status and alarm numbers.

## Before You Start

Make sure you have added a map and an access point to the client. See [Add Map](#) and [Add Device](#) for details.

## Steps

1. Enter the E-map module.
2. Click **Edit** on the E-map toolbar to enter the map editing mode.
3. Click **Add Hot Spot** → **Access Point Hot Spot** to open the Add Hot Spot window.

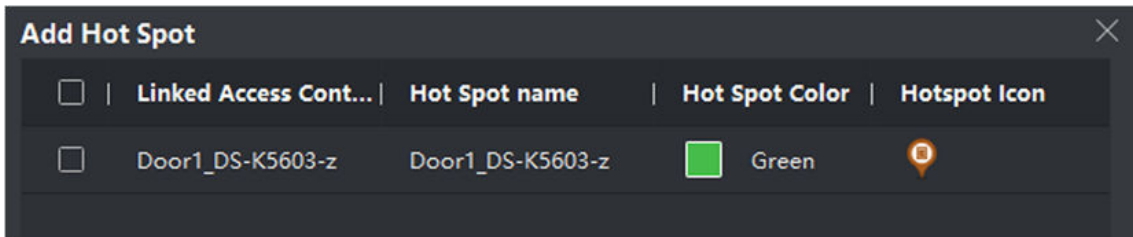

Figure 9-9 Add Hot Spot Panel

4. Select the access point(s) to be added to the map.
5. **Optional:** Edit the hot spot name, select the name color, and select the hot spot icon.
6. Click **OK**.

---

### Note

You can also drag an access point icon from the access point list to the map.

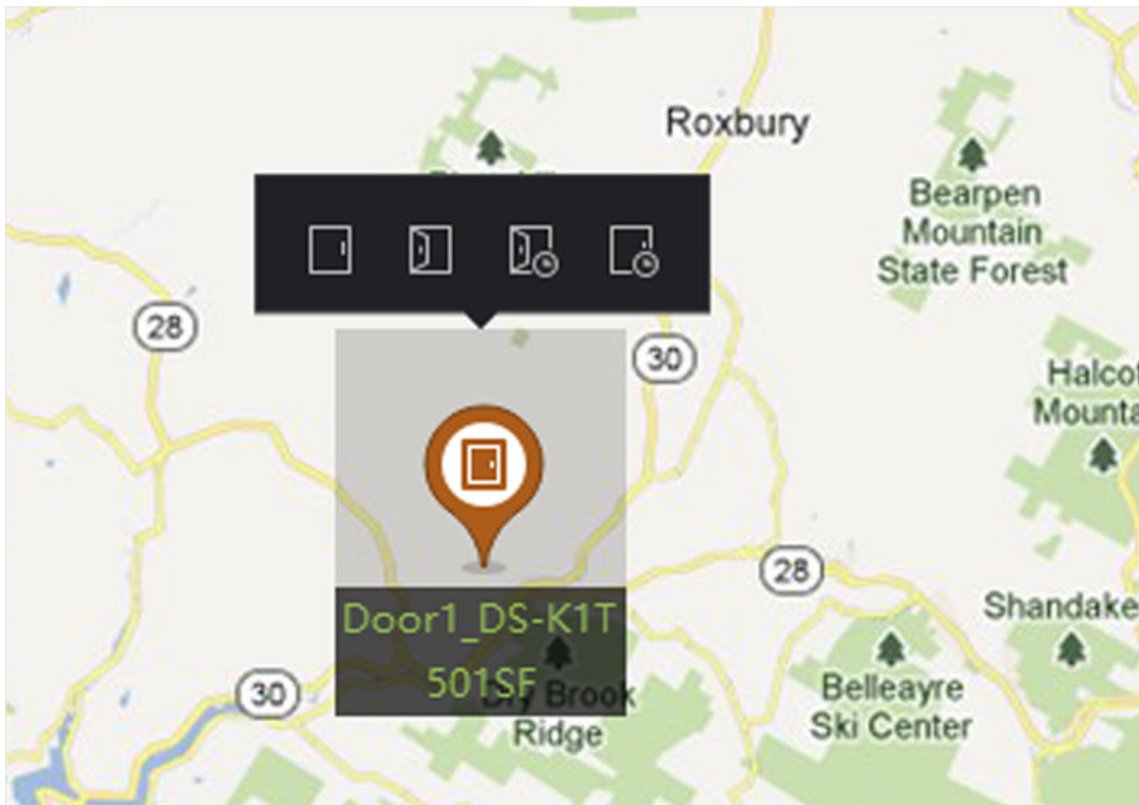



Figure 9-10 Access Point on the Map

---

The access point is added to the map as a hot spot and its icon in the group list changes from  to .

**7. Optional:** Drag the access point hot spot to move it to a certain position.

When alarms are triggered, the number of the newest alarms will be displayed on the hot spot icon. You can click the number to see the alarms details.

---

 **Note**

No more than 10 newest alarms can be displayed.

---

### 9.4.6 Configure Security Radar Hot Spot

The client supports adding a security radar to the map to work as a hot spot. After that, you can configure parameters (including drawing zones and trigger lines, setting smart linkage, map calibration, etc.) for the radar and the parameters you set will take effect on the device. In this way, an intelligent monitoring in the radar's detection area can be realized by the client.

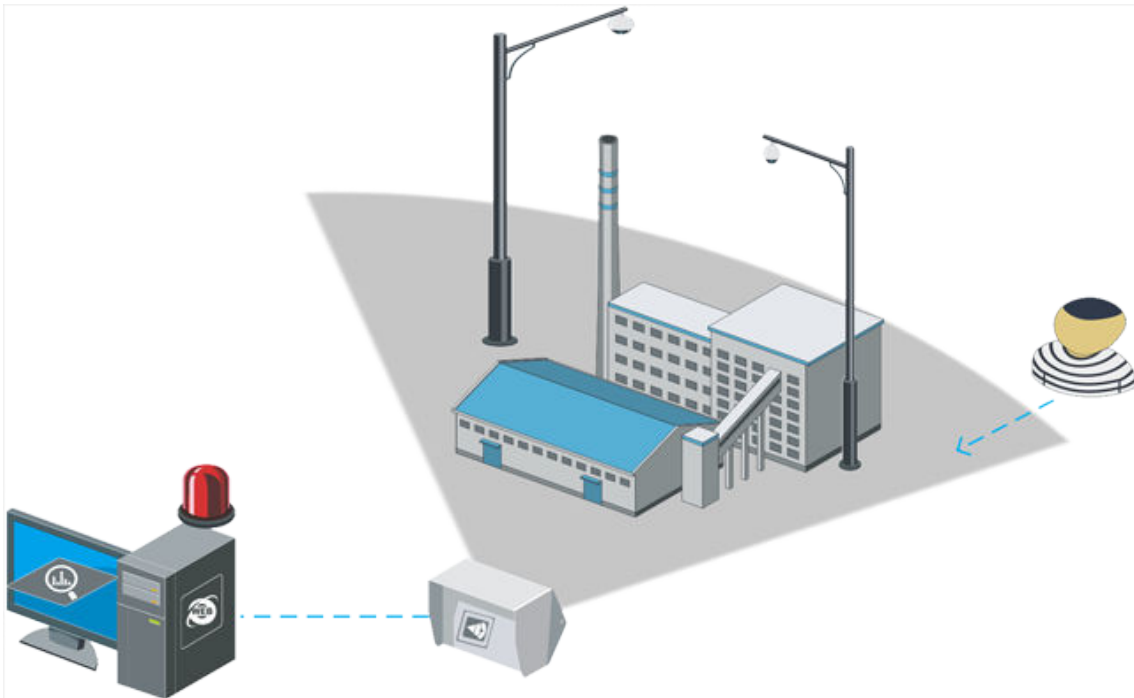

Figure 9-11 Scenario of Radar

## Add Security Radar as Hot Spot

For an effective monitoring, you can add a security radar to the map as a hot spot and paint zones in its monitoring filed. So that when someone intrudes the zone, an alarm will be triggered for attention.

### Before You Start

Make sure you have added an e-map and a security radar to the client. See [Add Map](#) and [Device Management](#) for details.

### Steps

1. Enter the E-map module.
2. Click **Edit** on the E-map toolbar to enter the map editing mode.
3. **Optional:** Edit map scale. See [Edit Map Scale](#) .
4. Select a security radar in the device list and drag it to the map.
5. **Optional:** Click the added radar and then click  to edit the hot spot name, select the hot spot color, and select the hot spot icon.
6. Click **OK**.



The security radar is added to the map as a hot spot and its icon in the group list changes from  to  . The sector indicates the monitoring field of the radar.



Figure 9-12 Radar on the Map

---

 **Note**

- Orange sector indicates an armed radar, while black sector indicates a disarmed radar.
- Red point indicates the detected intruder.

---

**7. Optional:** Drag the security radar to move it to a certain position.

## Draw a Zone

Zone is a basic concept in the security control system. It refers to a protection area in a radar's detection area, and is regarded as the maximum recognizable unit to distinguish the alarm event, determining whether to trigger an alarm according to the zone type and radar's arming status. You can see the target's location on the map the minute an alarm is triggered so as to take quick actions accordingly.

### Before You Start

Make sure you have disarmed the radar: click **Finish**, and select **Disarm** after clicking the radar's icon.

## Steps

1. Enter the E-Map module, and click **Edit** on the top right to enter the Edit mode.
2. **Optional:** Enable **Field Assistance** on the top left of the map. The target track will appear on the radar detection area. You can draw a zone with reference to the track.
3. Draw a zone.

**Method** Step

**Draw a Zone Manually** Click **Radar Settings** → **Draw Zone Manually** on the top of the map, and draw a zone on the radar detection area.

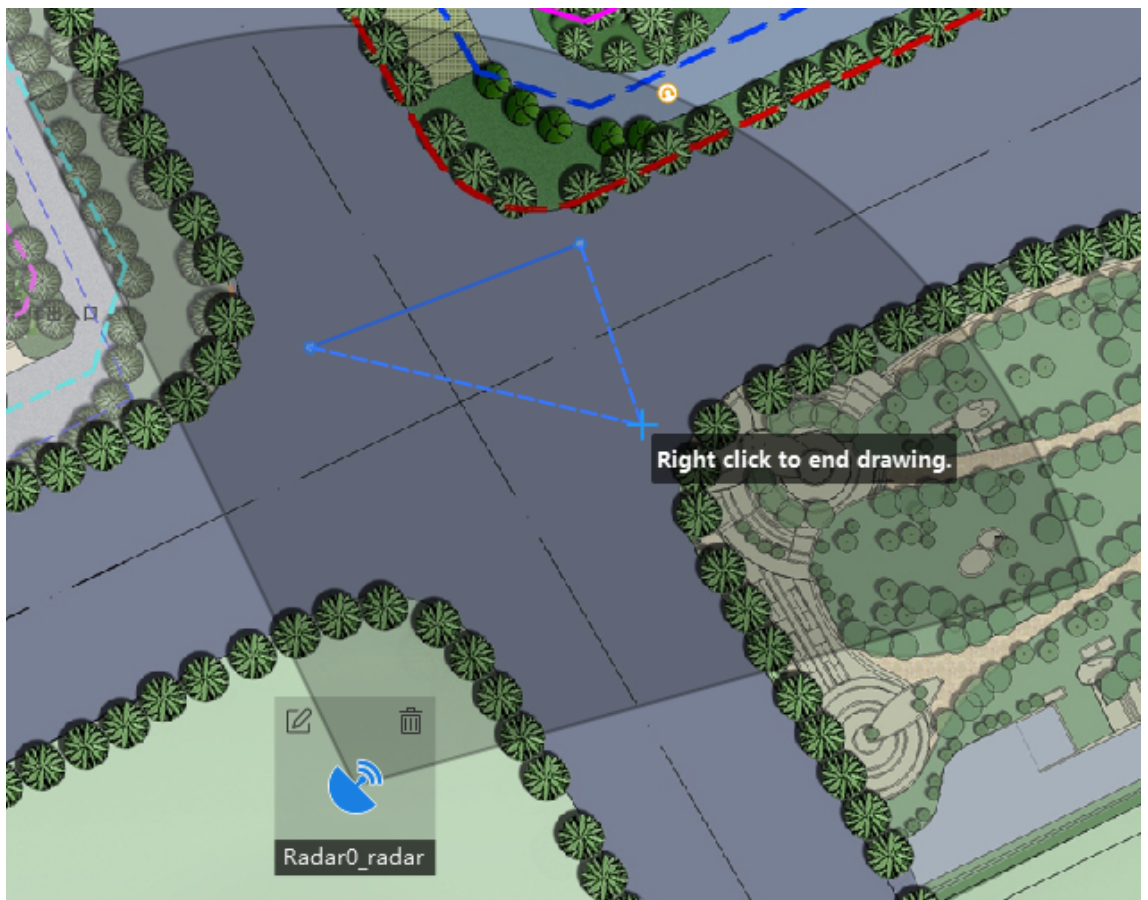

**Figure 9-13 Draw a Zone Manually**

**Draw a Zone Quickly**

Click **Radar Settings** → **Draw Quick Zone** on the top of the map, and left-click on the radar detection area to confirm the position of the zone.

 **Note**

Currently, the default shape of the zone is square and it is not editable.





**Figure 9-14 Draw a Quick Zone**

4. Right-click to complete drawing, and a window will pop up. Enter the zone name, and select **Early Warning Zone**, **Warning Zone**, or **Disabled Zone** as the zone type.

#### **Early Warning Zone**

The early warning zone will identify target that has potential risks in advance and trigger an alarm, but will not store alarm track. The early warning zone is green.

#### **Warning Zone**

The warning zone will identify the targets entering the area and trigger alarm. The warning zone is orange.

#### **Disabled Zone**



The disabled zone will block the target track in the area. The disabled zone is black.



#### **Note**

- Adding zones is a batch operation. If you plan to add zones for only one radar, you need to right-click on the remaining radar detection area to cancel drawing a zone in detection area of other radars after drawing the desired zone.
- When drawing a zone, the actual lengths of the edges of the zone will be displayed; after drawing a zone, you can double-click it to view the actual lengths of its edges.
- Zones can overlap, the priority of the effective overlapping zone is: Disabled Zone>Warning Zone>Early Warning Zone. That is, Early Warning Zone can contain Warning Zone and Disabled Zone, and Warning Zone can contain Disabled Zone.
- You can zoom in/out to adjust the size of the displayed radar area.

- 
5. Click **OK**.
  6. Click **Finish** on the top right of the map.
  7. **Optional:** After adding the zone and disarming the radar, double-click the zone to enter the editing mode, and perform the following operation(s) if needed.

<b>Add a Marker</b>	Hover the cursor on the line of the zone and it will change to a cross, and then click to add a marker.
<b>Change the Zone Shape</b>	Drag the marker to change the shape of the zone.
<b>Move a Zone</b>	Select a zone and drag the zone to move it.
<b>Delete a Zone</b>	Click  to delete a zone.
<b>Edit a Zone</b>	Click  to edit the zone name and type.

## Draw Trigger Line

A trigger line refers to a virtual line drawn in a radar's detection area on the map. An alarm will be triggered when someone crosses it in its pre-defined direction.

### Before You Start

The radar is added to the map. Click **Finish** on the top right to exit the editing mode. Click on the radar icon and select **Disarm** to disarm the radar.

### Steps

1. On the E-map page, click **Edit** to enter the editing mode.
2. Click **Radar Settings → Draw Trigger Line**, and select **Trigger Line** or **Dual-Trigger Line**.

---

#### Note



Drawing a dual-trigger line that is too tortuous will cause a failure.

---

3. Draw trigger line.
  - 1) Click on the radar detection area to draw a trigger line.
  - 2) Select **Left -> Right**, **Left <- Right** or **Left <-> Right** in the pop-up window.
  - 3) **Optional**: Enter the distance between two lines. (Only for dual-trigger line)

---

#### Note

- Alarm rules: A single arrow  indicates that the target triggers an alarm when it crosses the trigger line in the direction of the arrow; a double arrow  indicates that the target triggers an alarm when it crosses the trigger line in any direction.
  - The alarm can be triggered by crossing the Trigger Line according to the alarm rule; the alarm can be triggered only after crossing double lines of Dual-trigger Line according to the alarm rule.
  - Direction determination: suppose you stand at the penultimate marker facing the last marker, the area on your left indicates the Left, while the area on your right indicates the Right.
  - Up to 4 trigger lines can be drawn.
  - Up to 1 dual-trigger line can be drawn.
  - The trigger line cannot cross each other.
-



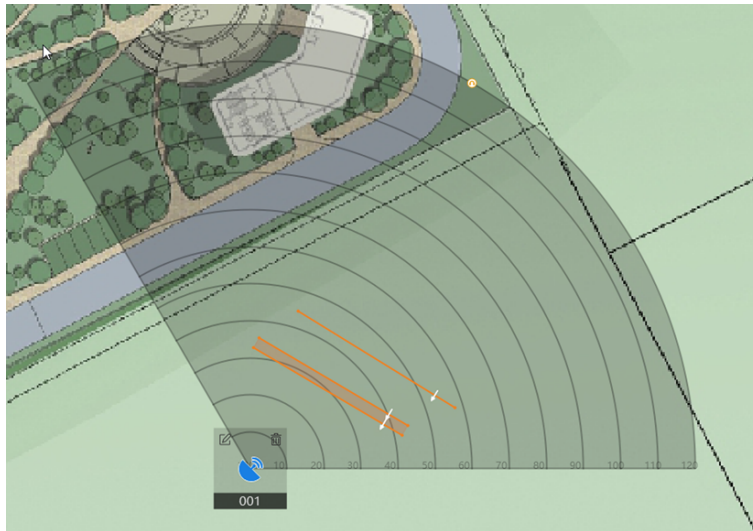



**Figure 9-15 Draw Trigger Line**

4. Click **OK**.

5. **Optional:** Click on the trigger line will appear different options: **Edit**, **Delete** and **Move**. You can edit the trigger line by clicking on it.

- Add a Marker: Click on the line to add a marker.
- Drag a Marker: Drag a marker on the trigger line to move it.
- Move the Trigger Line: Hold the editing area to move the trigger line.
- Edit: Click  to edit the trigger line name, trigger line rule and distance (only for Dual-trigger Line).
- Delete: Click  to delete the trigger line.

## Add Track Filter Zone

Track Filter Zone is an area in radar's detection area. When an object enters the track filter zone, alarms will not be triggered, and the object's moving pattern will not be uploaded to the client. This function is applicable for places with plenty of disturbing factors (such as trees) that may cause wrong alarms.

### Before You Start

Make sure you have added a radar to map and have disarmed the radar. See [\*\*\*Add Security Radar as Hot Spot\*\*\*](#) for details.

### Steps

---

#### Note

- This function should be supported by the device.
  - Up to 32 track filter zones are supported.
  - The size of track filter zone depends on device capability.
-

1. On the top right of the map, click **Edit** to enter the editing mode of the map.
2. Click **Radar Settings** → **Track Filter Zone** → **Add Track Filter Zone** .
3. On the map, hold the mouse and drag to set the semi-diameter of the track filter zone. Right-click to end drawing.

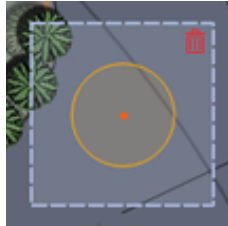

**Figure 9-16 Track Filter Zone**

**4. Optional:** Perform the following operations.

- |                                       |  |
|---------------------------------------|--|
| <b>Edit Track Filter Zone</b>         | Double-click the track filter zone, hover the cursor on the border. When the cursor turns to a blue +, hold the mouse and drag to adjust the area.       |
| <b>Move Track Filter Zone</b>         | Double-click the track filter zone, and drag it to move it.  |
| <b>Display/Hide Track Filter Zone</b> | Click <b>Radar Settings</b> → <b>Track Filter Zone</b> → <b>Display/Hide Track Filter Zone</b> to display or hide the track filter zone on/from the map. |
| <b>Delete Track Filter Zone</b>       | Double-click the track filter zone, and click  .                    |

## Add Point Cloud Filter Zone

After the radar detects the object, multiple points will be reported to the device and form the point cloud. Point cloud filter zone is an area in radar's detection area. Configuring it before environment learning can improve the accuracy of environment learning. When the object enters the point cloud filter zone, the point will not be reported to the device. This function is applicable for places with plenty of disturbing factors to reduce false alarms.

### Before You Start

Make sure you have added a radar to map and have disarmed the radar. See [Add Security Radar as Hot Spot](#) for details.

### Steps

---

#### Note

- This function should be supported by the device.
  - Up to 16 point cloud filter zones are supported.
  - The size of point cloud filter zone depends on device capability.
-

1. On the top right of the map, click **Edit** to enter the editing mode of the map.
2. Click **Radar Settings** → **Point Cloud Filter Settings** → **Draw Point Cloud Filter Zone** .
3. On the map, left-click to start drawing and right-click to end drawing.

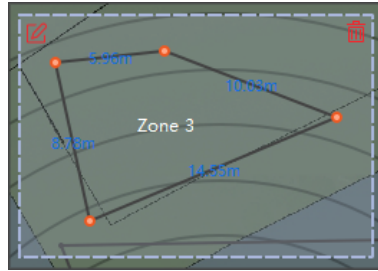

**Figure 9-17 Point Cloud Filter Zone**

4. Enter the name of the point cloud filter zone.
5. Click **OK**.
6. **Optional:** Perform the following operations.

<b>Edit Point Cloud Filter Zone</b>	Double-click the point cloud filter zone, hover the cursor on the border. When the cursor turns to a blue +, drag to adjust the area.
<b>Move Point Cloud Filter Zone</b>	Double-click the point cloud filter zone, and drag it.
<b>Delete Point Cloud Filter Zone</b>	Double-click the point cloud filter zone, and click  .

## Set Smart Linkage

Smart linkage works based on the calibration points you adds to the radar's detection area. That is the calibration points can tell the PTZ camera linked to the radar which direction to turn to when a target is detected so as to get the live view and track of the target by the client.

---

### **Note**

Make sure you have performed the following operations before calibration:

- You need to disarm the radar before calibration: click **Finish** on the top right to exit the editing mode. Click the radar icon and select **Disarm** to disarm the radar.
  - You need to link the PTZ camera to the zone before calibration, and set the PTZ camera initial position. See the PTZ camera user manual for details about how to set the PTZ camera initial position.
  - Import the PTZ camera linked to the radar to the radar's group. See **Group Resources** for details.
  - The installation height of the linked PTZ camera should be higher than 3 meters.
  - Only PTZ camera supports this function.
-

According to the relative installation position of the radar and the camera, it is necessary to select a schedule (One-Point Calibration or Multi-Point Calibration) for the calibration point selection.

### One-Point Calibration

Applicable to the scenario where the radar and the camera are installed on the same pole or the camera is installed within a radar-centered range of 2 meters (regardless of the altitude difference between the camera and the radar).



Figure 9-18 Scenario of One-Point Calibration

### Multi-Point Calibration

The scenario which is not applicable to the one-point calibration needs to adopt the multi-point calibration.



**Figure 9-19 Scenario of Multi-Point Calibration**

## One-Point Calibration

One-point calibration is applicable to the scene where the radar and the camera are installed on the same pole or the camera is installed within a radar-centered range of 2 meters (regardless of the altitude difference between the camera and the radar).

### Before You Start

To perform this function, a cooperation between two persons is required. Person A enters the detection area so that person B (the operator of the client) can see A's track on the client. And then B sets calibration points by the client according to A's track.

### Steps

1. Click **Edit** on the top right of the map.
2. Click **Radar Settings** → **Smart Linkage Settings** → **Linked Positioning Settings** .
3. On the Smart Linkage Settings page, select a radar from the drop-down list on the top left.
4. Click a live view window at the bottom and select a camera in the **Linked Camera** list. The live view window displays the camera's live view.
5. Double-click the camera's live view window to enlarge it.

---

### **Note**

You can click + or - to zoom in/out the map.

---

6. Select **One-Point Calibration** as the calibration mode.
7. Select the track of person A. Ask person A to move into the radar detection area. By comparing the moving object in the live view window of the camera and the track in the radar detection area, person B needs to select the track of person A and click it. The color of the selected track will turn from red to white.

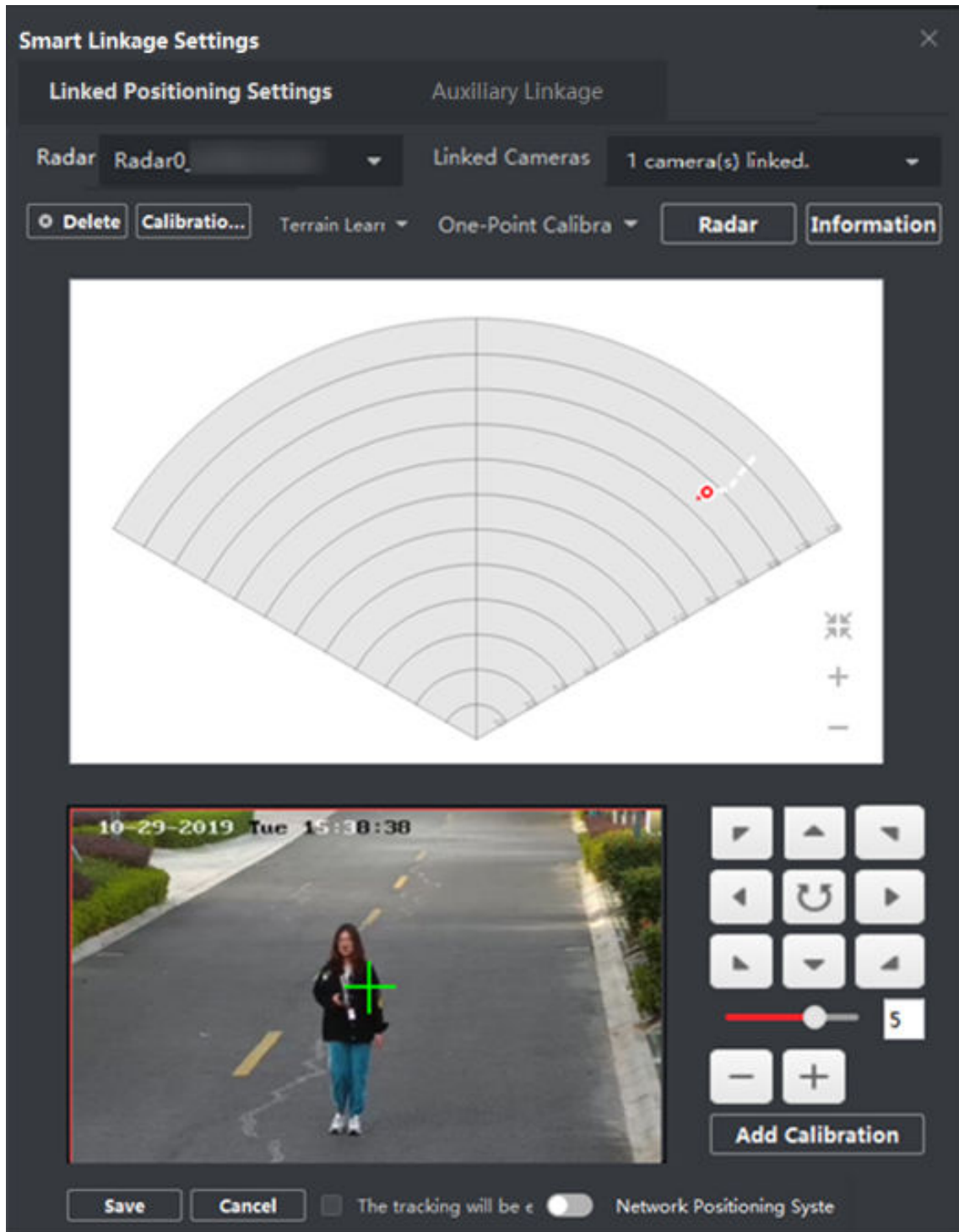



Figure 9-20 Select the Track

8. Ask person A to move to the calibration point within 20 to 40 m directly in front of the radar, and then stand at the calibration point.

9. Adjust the PTZ buttons in the live view window to get the PTZ position: Click + and - to adjust the altitude of person A to two-thirds of the altitude of the window, and click the direction buttons to align the central sign  with person A (For precise alignment, click on the center of the object and the screen will adjust automatically).
10. Click **Add Calibration** to add a calibration point. The PTZ position and the radar position of person A will be shown in the **Information** list. The option **The smart linkage will be enabled after completing the settings.** will be checked automatically.

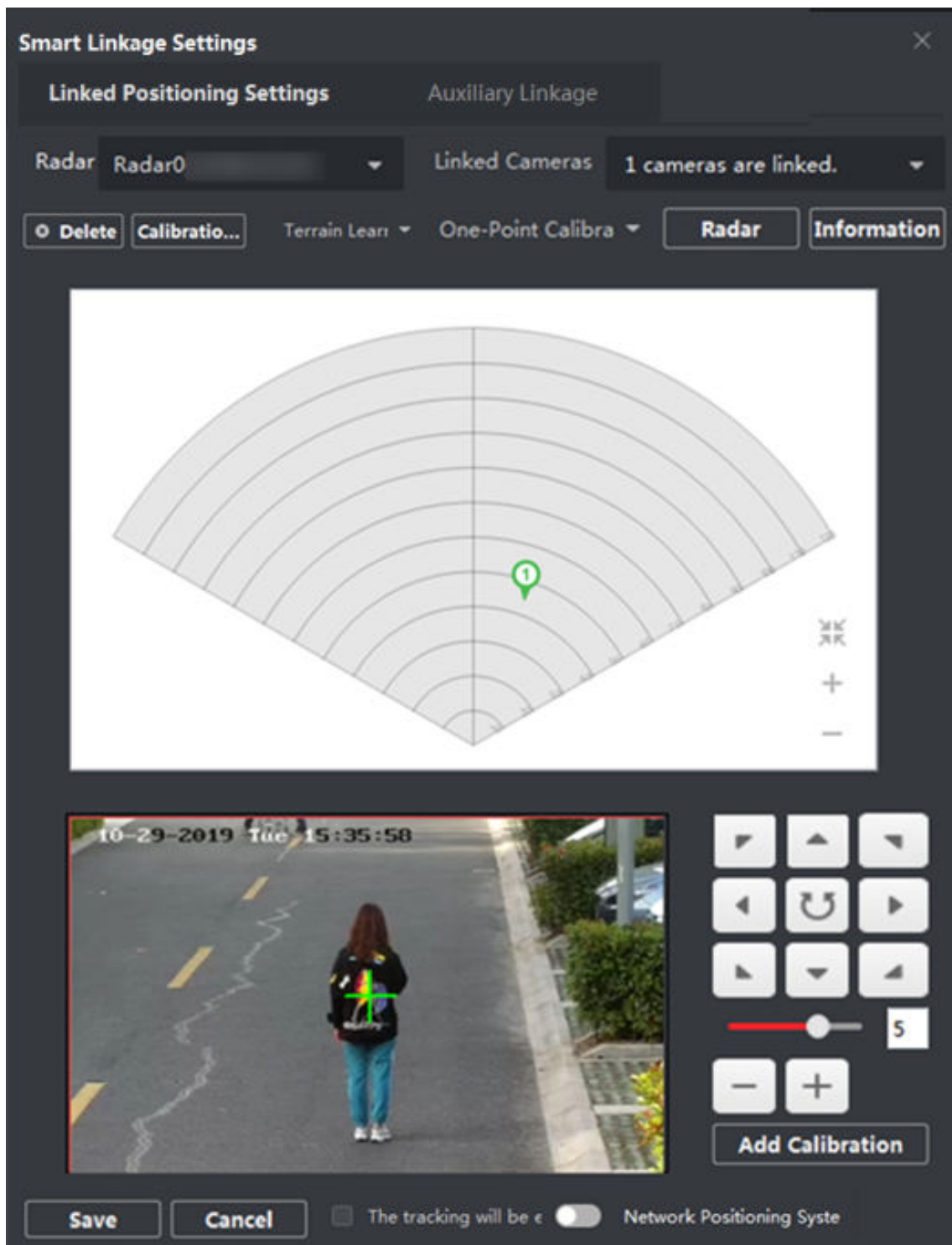

Figure 9-21 Add a Calibration

11. Click **Save**.



## Multi-Point Calibration

Multi-point calibration is applicable to the scenario where the distance of the radar and the cameras linked to it is more than 2 meters.

### Before You Start

This function needs the cooperation between 2 persons. Person A enters the detection area so that person B (the operator of the client) can see A's track according to which B set the calibration points by the client.

### Steps

1. On the Smart Linkage Settings page, select **Multi-Point Calibration** as the calibration mode.
2. Select calibration points (equally distributed) on the center line of the radar's detection area, you can refer to the following figure to select points.



Figure 9-22 Multi-Point Distribution Instance

---

### Note

At least 4 calibration points are required.

3. According to the calibration points, person A moves to a calibration point, and refer to step 2 to step 5 in One Point Calibration to calibrate the calibration point.
4. When the first calibration point is set, let person A move to the next calibration point after the yellow track disappears. And then refer to step 2 to step 5 in One Point Calibration to set the next calibration point. Follow this process to set all other calibration points in turn.

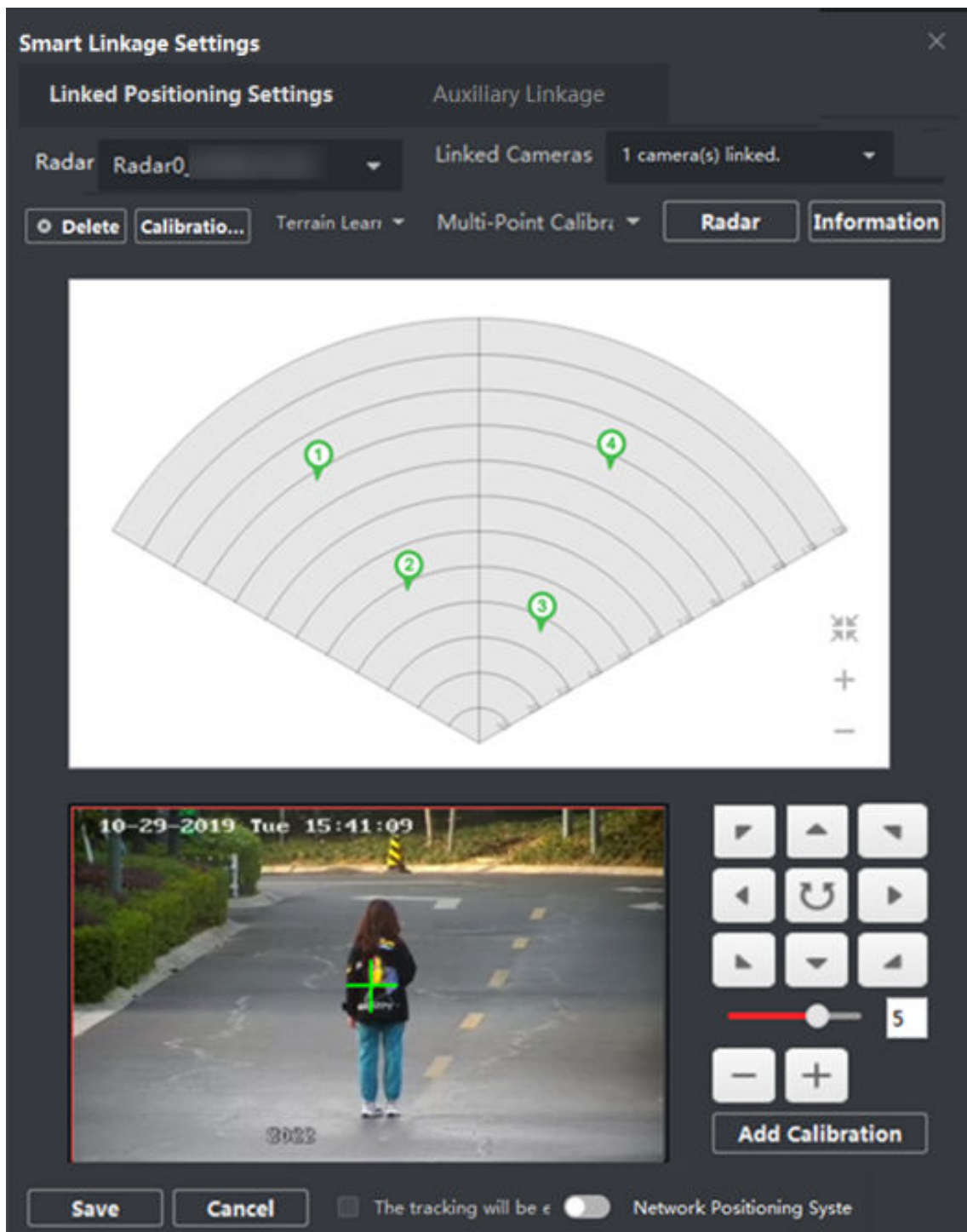

Figure 9-23 Multi-Point Calibration Radar Page

---

 **Note**

Click **Delete** to delete a calibration point after selecting the calibration point in the Information list.

- 
5. Click **Save** after all calibration points are set.

---

 **Note**

You can save the calibration information successfully only if there are 4 calibration points, otherwise you cannot save it.

---

## GPS Calibration

GPS Calibration refers to calibrating by device longitudes and latitudes, radar's orientation, and linked PTZ camera's position angle.

### Before You Start

- Record the radar's longitude, latitude, and orientation.
- Record the linked PTZ camera's longitude, latitude, and position angle.

### Steps

1. On the Smart Linkage Settings page, click **Set Longitude and Latitude** to open the Set Longitude and Latitude window.
2. Enable **Enable GPS Calibration**.
3. Enter **Radar Longitude** and **Radar Latitude**, and **Radar Orientation**.

---

 **Note**

See radar user manual for details about setting radar orientation.

- 
4. Enable **Network Positioning System**.

---

 **Note**

You can also enable or disable this function on the Smart Linkage Settings page.

- 
5. Enter **Camera Longitude**, **Camera Latitude**, and **Position Angle**.

---

 **Note**

See PTZ camera user manual for details about setting position angle.

- 
6. Click **OK**.

## Set Auxiliary Linkage

Auxiliary Linkage is to add presets to the camera linked to the radar to help the radar accurately turn to the target with the assistance of presets. After adding presets, the camera will automatically turn to the presets if a target is detected, and in this way you can view the image of the target via the Client.

**Before You Start**

- Make sure you have calibrated the linked camera. For detailed information, see **One-Point Calibration** or **Multi-Point Calibration** .
- Make sure you have configured zones. For detailed information, see **Draw a Zone** .

**Steps**

1. Click **E-map**.
2. Click **Radar Settings** → **Smart Linkage Settings** → **Auxiliary Linkage** .

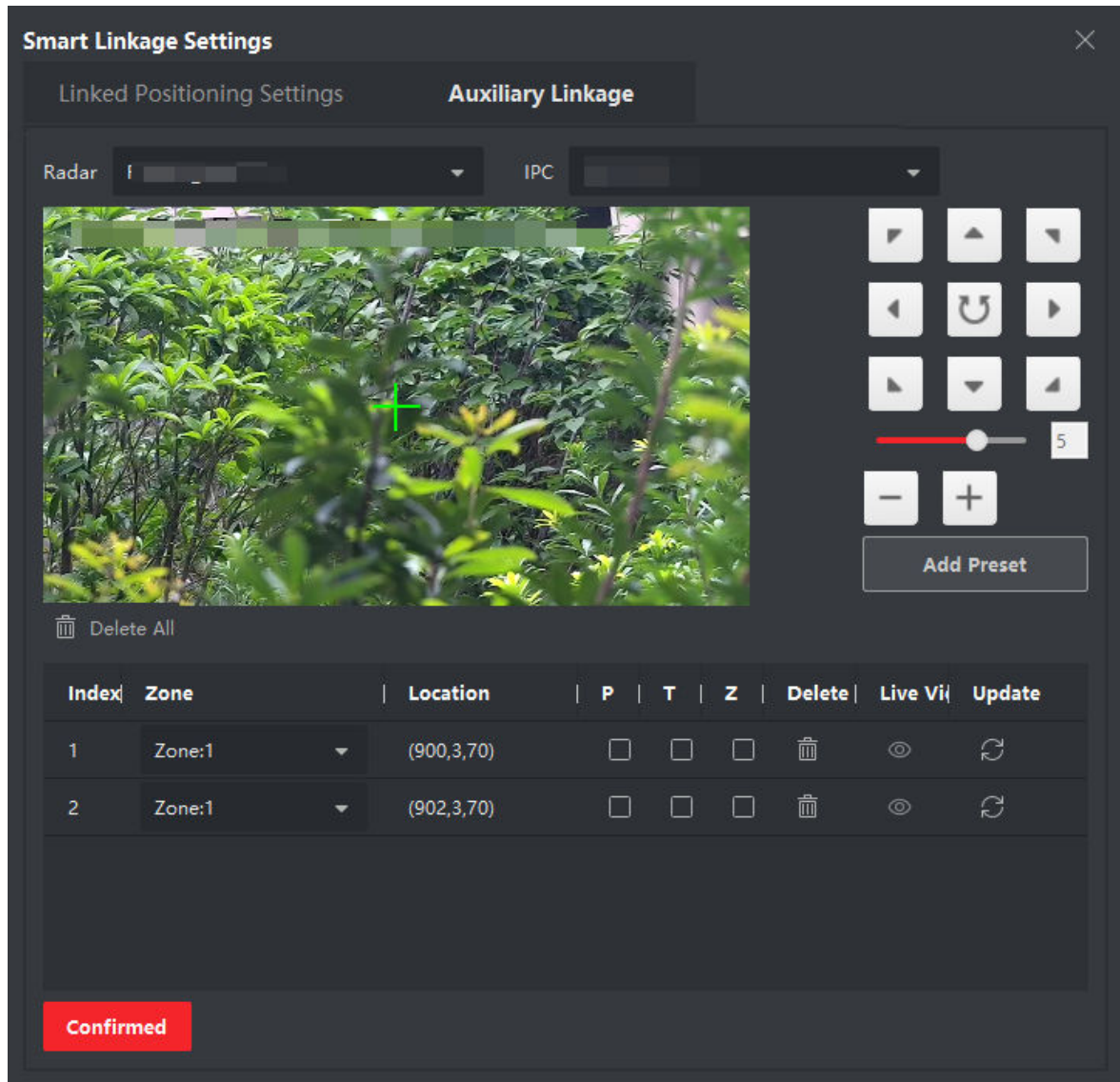

**Figure 9-24 Auxiliary Linkage**

3. Select a radar and a camera from the drop-down list.

---

## Note

Make sure you have set the **Linked Camera** on the Smart Linkage Settings page, and saved the settings.

---

4. Click **Add Preset**.
5. Select a zone in the list.
6. **Optional**: Edit preset.

Button	Description
<b>PTZ</b>	Check P/T/Z, the checked value of the camera will remain unchanged.
<b>Delete</b>	Delete the preset.
<b>Live View</b>	Use the camera to view the presets.
<b>Update</b>	Update the preset coordinate to the current camera coordinate.

---

## Note

The situation when you need to set PTZ is that if the calibrated camera cannot turn to the preset accurately, you can set P/T/Z to make it more accurate. You can check them all to fix the camera if the region is small or the terrain is not very undulating.

---

7. Use function buttons on the right to adjust the camera screen center position (cross icon position) to the watch point. You can click a position in the image and the position will become the center of the image.
8. Click **Confirmed**.

## Set Environment Learning

To improve the accuracy of radar detection, you need to make the radar complete the environment learning.

---

## Note

Make sure you have added the radar to the e-map.

---

Select a radar on the e-map in the client software, and click **Environment Learning** to start the environment learning.

---

## Note

- The time for the environment learning is 10 seconds by default.
  - Every time the radar starts to learn the environment, the previous learning data will be overwritten automatically.
  - You can log in to the radar's remote configuration page via a web browser to configure the environment learning parameters. For details, refer to the user manual of the device.
-

## Terrain Learning

By terrain learning, the radar can get the terrain of its detection area and make more accurate smart linkage.

### Before You Start

Make sure you have completed calibration. See [\*\*One-Point Calibration\*\*](#) and [\*\*Multi-Point Calibration\*\*](#) for details.

### Steps

---

#### Note

- This function should be supported by the device.
  - To use this function, a cooperation between two persons is needed. Person A enters the radar's detection area, while person B operates the PTZ camera linked with the radar and display person A in the live view of the PTZ camera on the Smart Linkage Settings panel.
- 

1. On the Smart Linkage Settings panel, click **Terrain Learning → Start Terrain Learning** .
2. In the radar's detection area, select person A's moving pattern.
3. Control the PTZ camera to keep person A in the center of the live view page by the buttons on the right.



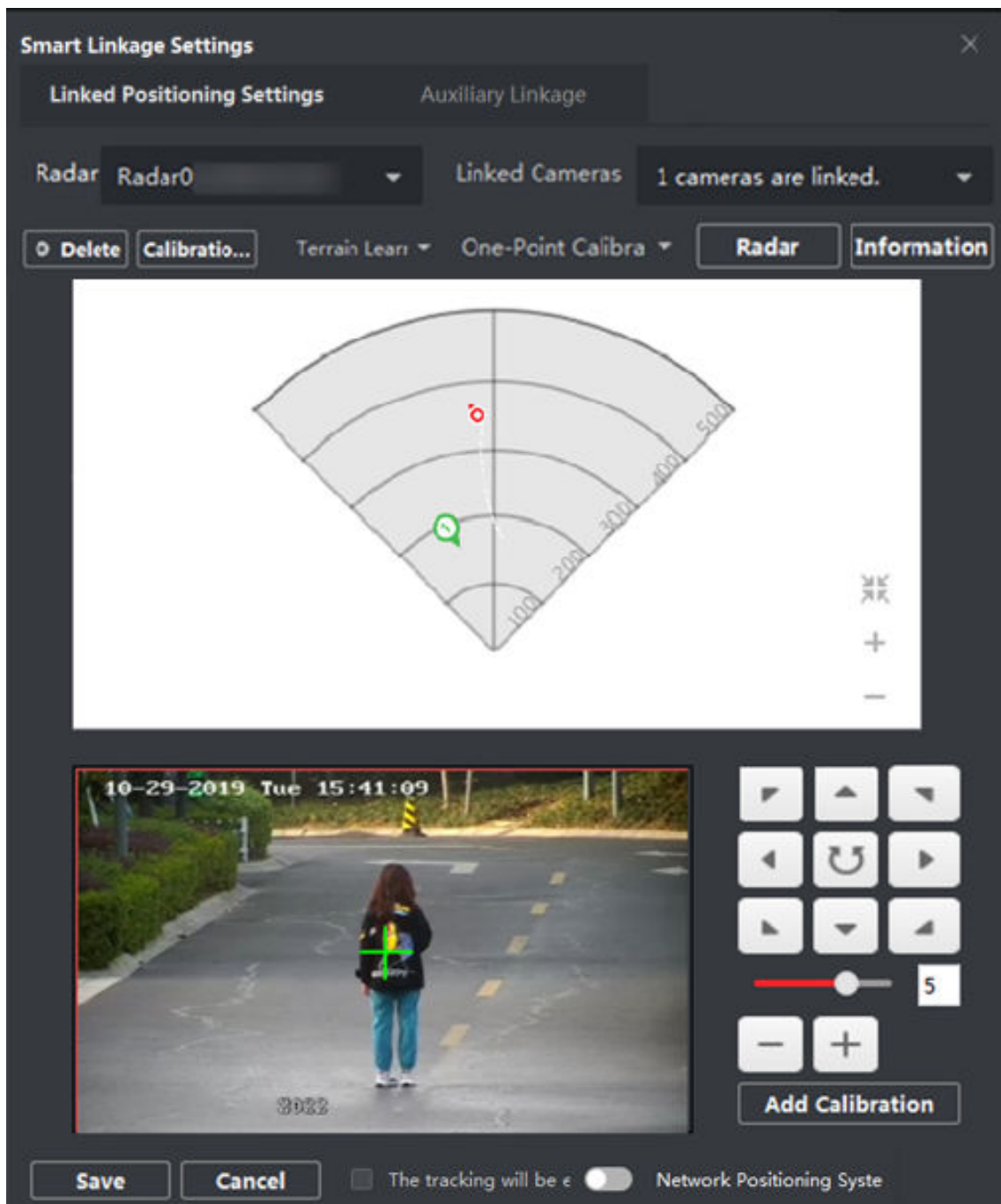

Figure 9-25 Terrain Learning

4. Click **Terrain Learning** → **Finish Terrain Learning** to end terrain learning.

 **Note**

Old terrain learning results will be overwritten by new results.

5. **Optional:** Click **Terrain Learning** → **Clear Terrain Learning** to clear existing terrain learning results.

## Calibration Compensation

Calibration Compensation makes calibration more accurate by adjusting Pan, Tilt, and Zoom of radar-linked PTZ camera.

### Before You Start

Make sure you have finished a calibration.

### Steps

1. On the Smart Linkage Settings page, click **Calibration Compensation** to open the Calibration Compensation window.
2. Select a camera from the Camera list.

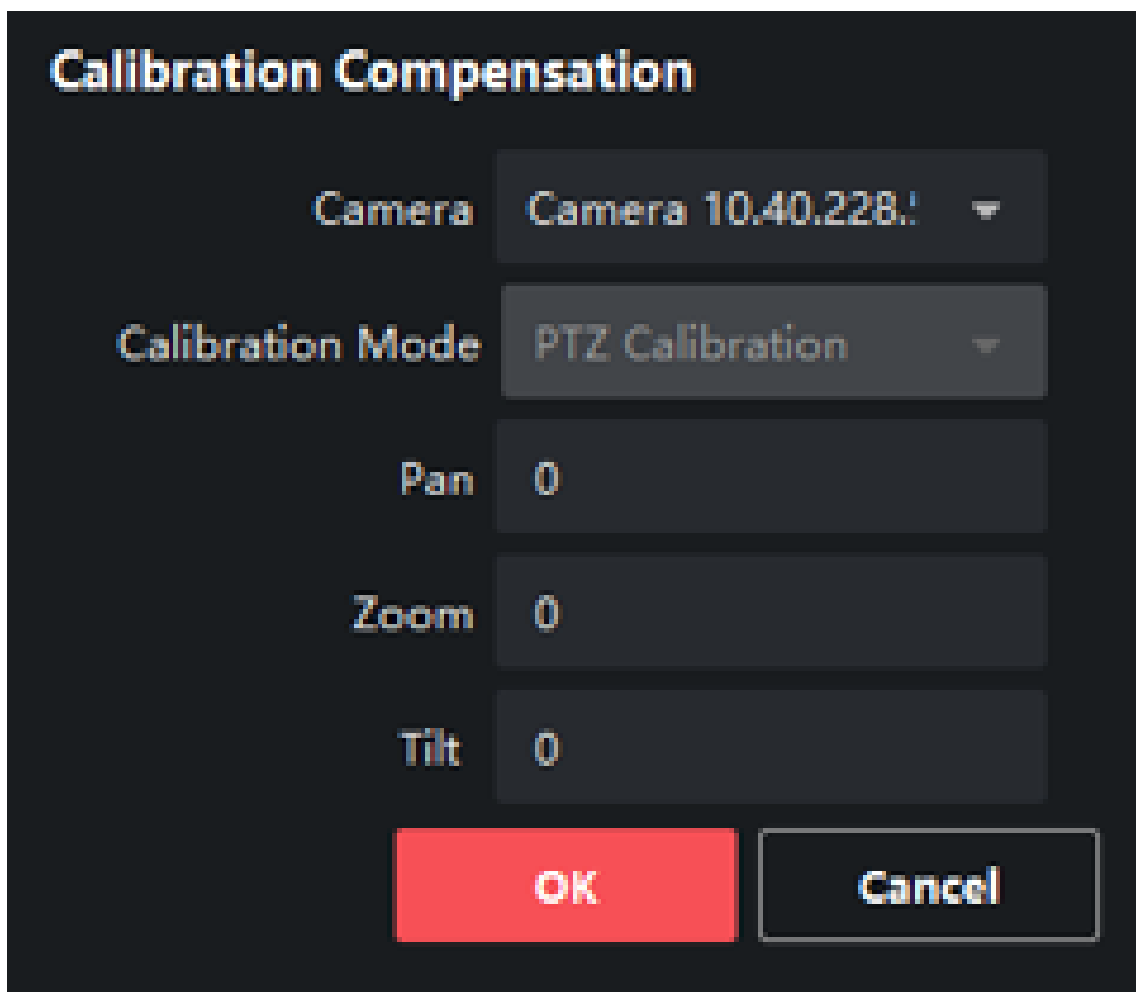

Figure 9-26 Calibration Compensation

3. Select a **Calibration Mode**.



## GPS Calibration

If you had conducted GPS calibration before, select this mode.

## PTZ Calibration

If you had conducted one-point calibration or multi-point calibration before, select this mode.

### 4. Enter the **Pan, Tilt, and Zoom**.

---



#### Note

The **Pan, Tilt, and Zoom** you entered here will be added to the former **Pan, Tilt, and Zoom**.

---

### 5. Click **OK**.

## Set Parking Points for Linked Camera

After enabling the radar parking mode, the radar will control the linked camera to return to the set parking point when no target appears within 10s in the radar detection area.

### Before You Start

- Add the radar to the map.
- Link the camera to the radar, and add the camera to the client.
- Calibrate the camera and enable camera master-slave tracking.
- You need to disarm the radar before the operation. Click **Finish** on the E-map page to exit the editing mode. Click the radar icon and select **Disarm** to disarm the radar.

### Steps

---



#### Note

This function is only applicable for cameras with PTZ control function.

---

1. Click **Edit** on the top right of the map to enter editing mode.
2. Click **Radar Settings** → **Set Parking Point** .
3. Select a radar from the drop-down list on the top.
4. Select a linked camera from the drop-down list.
5. Use buttons on the right to adjust the camera screen center position (cross icon position) to the watch point. You can click on the screen and the screen will automatically adjust to the clicked center. You can also click the image to make the position you clicked the center.



Adjust the rotation speed of the camera. 1 is the slowest and 7 is the fastest.

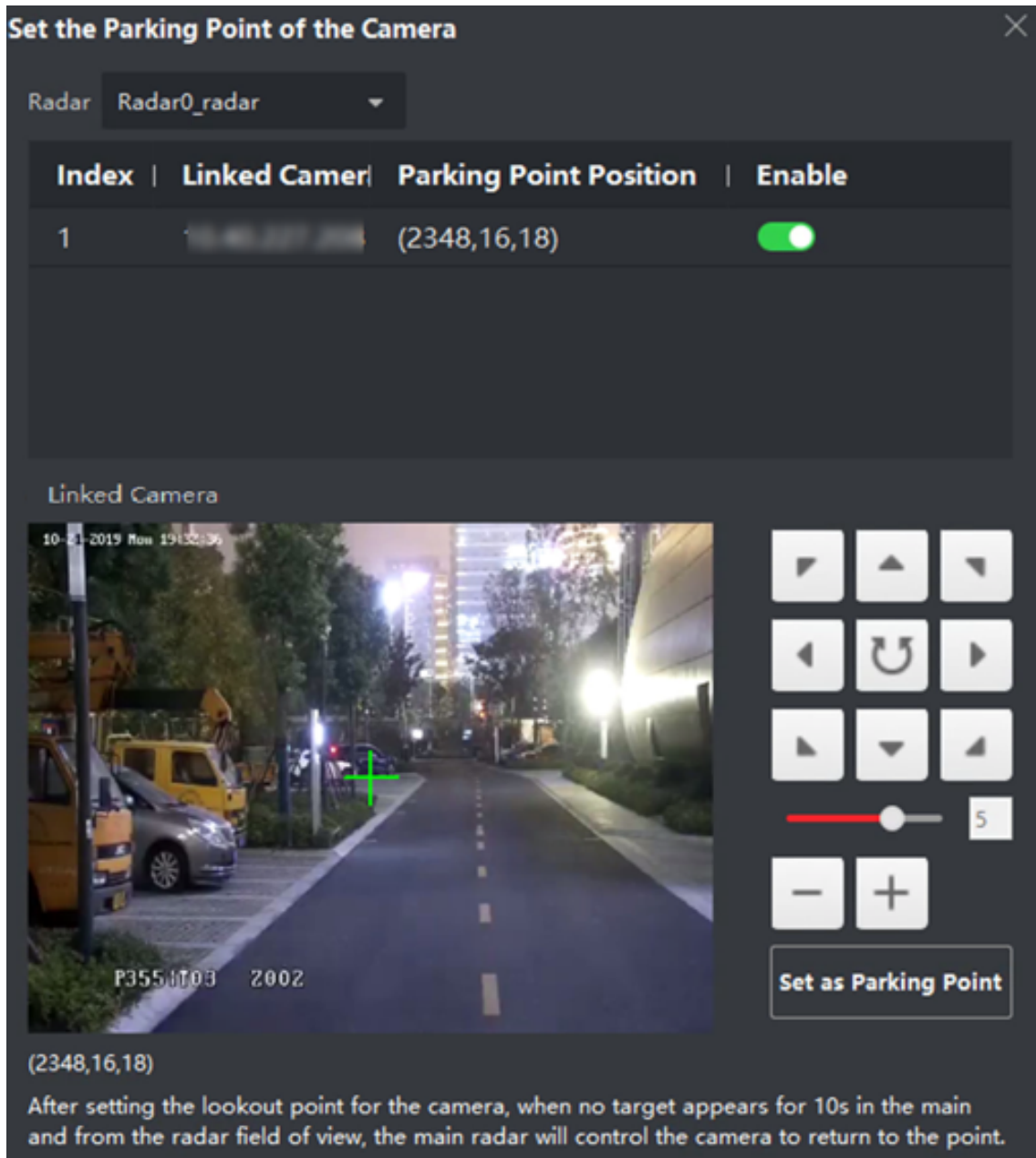

Figure 9-27 Set Parking Point

6. Click **Set as Parking Point**.

### Set Preset Point

You can set a preset point for a zone or a trigger line. When an alarm is triggered in the zone or trigger line, the camera will automatically turn to the corresponding preset point.

### Before You Start

- Add the radar to the map.
- Link the camera to the radar, and add the camera to the client.
- Zones and trigger lines are configured.
- You need to disarm the radar before the operation. Click **Finish** on the E-map page to exit the editing mode. Click the radar icon and select **Disarm** to disarm the radar.

### Steps

---



#### Note

This function is only applicable for cameras with PTZ control function.

---

1. Click **E-map** and click **Edit** to enter the editing mode.
2. Click **Radar Settings** → **Preset Point Settings** .

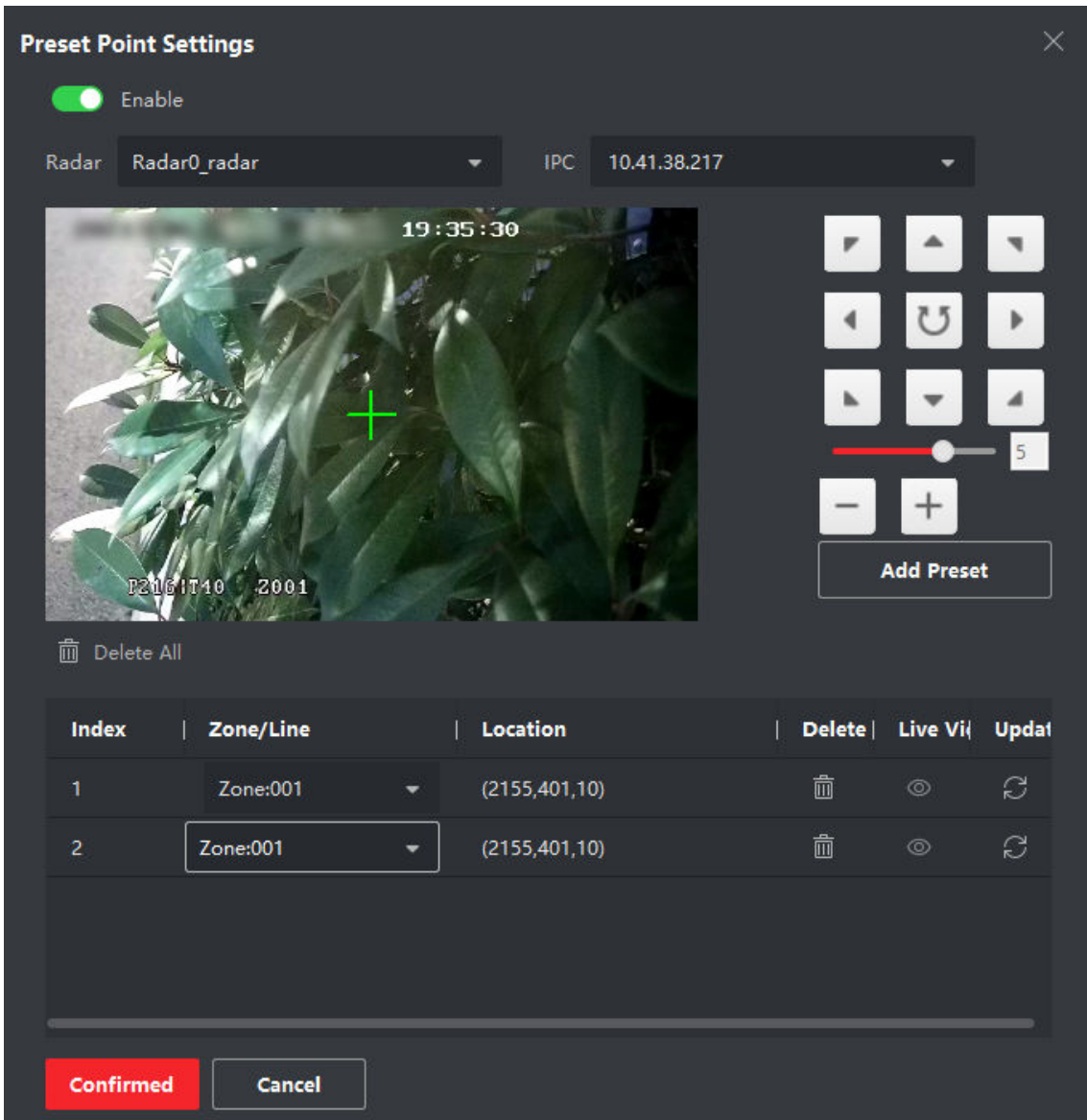

Figure 9-28 Preset Point Settings

3. Switch on **Enable**.
4. Select a radar and a camera from the drop-down list.
5. Use function buttons on the right to adjust the camera screen center (cross icon position) to the watch point.

**Note**

You can also click on the image and the clicked point will be the camera screen center.

Operation	Description
-----------	-------------



Adjust the camera direction. Hold to move the camera direction continuously.



Rotate the camera horizontally. Hold to continuously rotate the camera horizontally.



Adjust the rotation speed of the camera. 1 is the slowest and 7 is the fastest.



Zoom the screen.

6. Click **Add Preset**.
7. Select a zone or trigger line from the list.
8. **Optional**: Edit the preset point(s).

Button	Description
<b>Delete</b>	Delete the preset point.
<b>Live View</b>	Use the camera to view the preset point.
<b>Update</b>	Update the coordinate of the preset point according to the coordinate of the current camera.

9. Click **Confirmed**.

## Map Calibration

Map calibration is used to get the accurate scale of the map by the cooperation of three persons.

### Before You Start

Make sure you have added the radar (when adding the device, check **Import to Group**) to the client and the map, and have set a scale for the map.

### Steps

1. Click **Edit** to enter the editing mode.
2. Click **Radar Settings → Map Calibration**.
3. To perform this operation, an cooperation between three persons is needed. Person A and person B move into the radar's detection area. Person C selects their tracks by the client. A and B stop at the calibration points and the system will generate 2 markers at the terminal of tracks. Click **OK** on the pop-up window to confirm the terminal of the track or click **Delete** to select a new track.

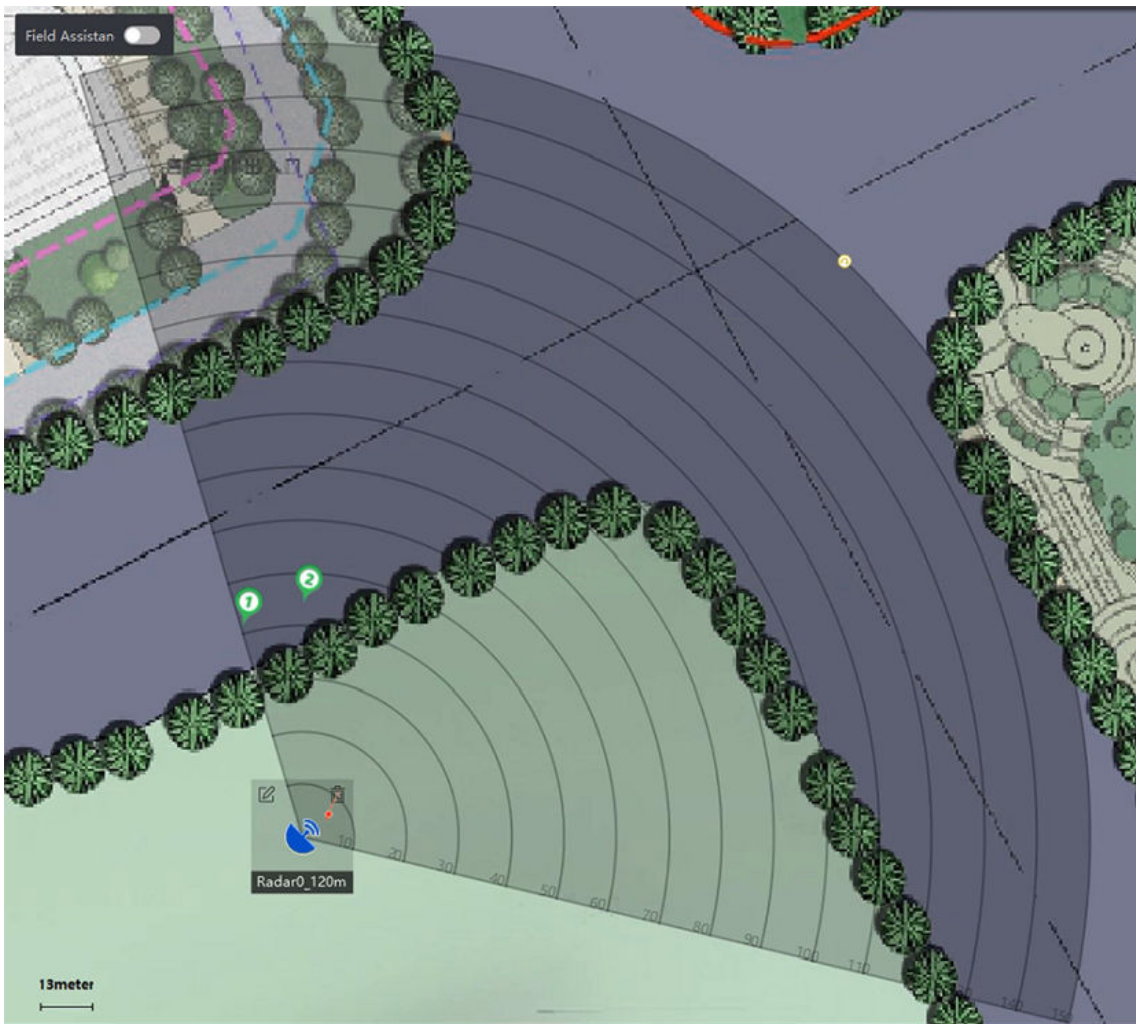

**Figure 9-29 Confirm Terminals**

4. Click on the map to confirm the actual locations of marker 1 and marker 2.



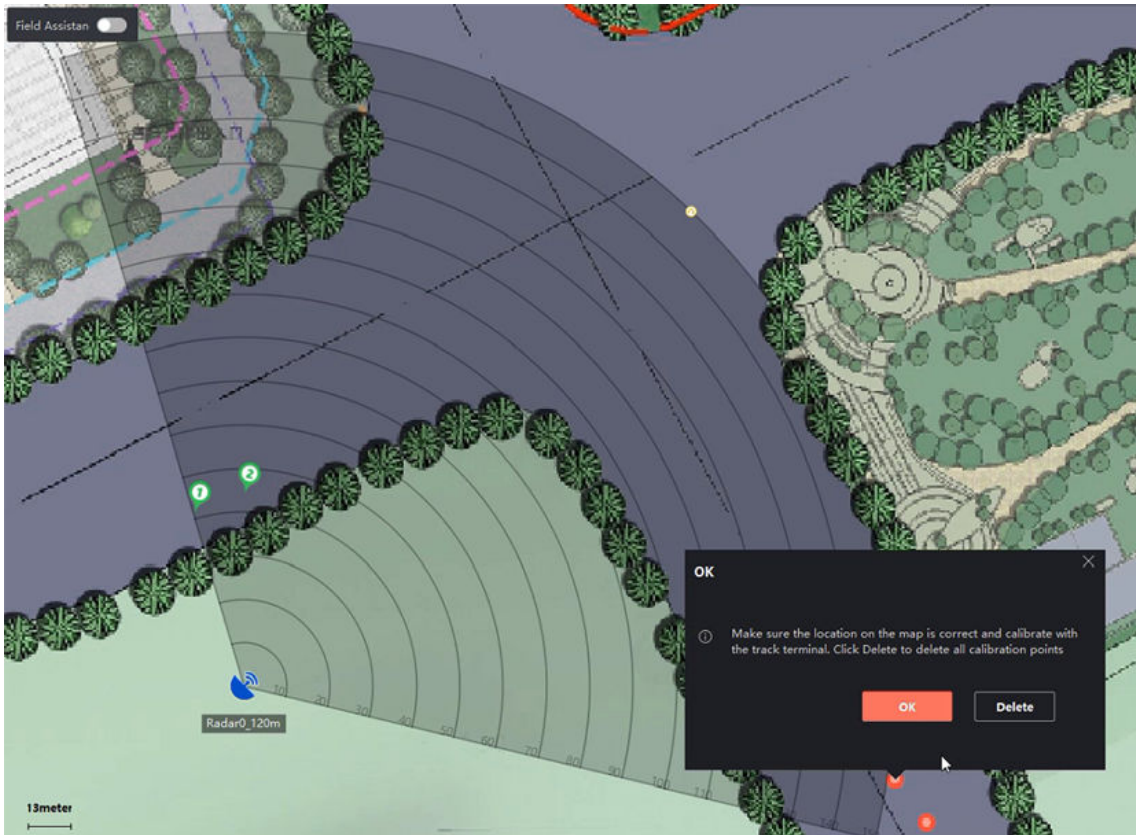

**Figure 9-30 Confirm Actual Locations**

5. A window pops up saying *Make sure the location on the map is correct and calibrate with the track terminal?* Click **Delete** to delete all calibration points. Click **OK** on pop-up window. The system will automatically match the markers to the actual locations.



**Figure 9-31 Finish Map Calibration**

## Other Functions

When using the radar, you can perform some auxiliary functions such as arming/disarming, refreshing radar parameters, displaying OSD and PTZ camera's FOV (field of view), and enabling alarm output to meet different needs.

---

### Note

Make sure you have exited the map editing mode before using the following functions.

---

### Environment Learning

Click **Environment Learning** to enable the environment learning mode for the radar. For details, refer to **Set Environment Learning** .

### Arm/Disarm All Radars

Click **Arm Radar** → **Arm All Radars/Disarm All Radars** to arm or disarm all radars on the map.

### Arm/Disarm Single Radar

After exiting the editing mode, click the radar's icon to show its operation menu.



## Arm a Radar

Arm the radar's detection area. A question will pop up saying *There are targets in the zone, enable mandatory arming?* if you arm the radar when a target exists in the warning zone. You can click **OK** to arm the radar mandatorily.



### Note

The radar cannot be edited if it is armed.

---

## Disarm a Radar

Disarm the radar's detection area.

## Event

Search alarms triggered by certain cameras during certain time range, and view the alarm related videos. See ***Preview Hot Spot*** for details.

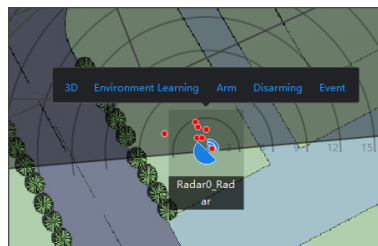

Figure 9-32 Radar's Function List

## Enable Alarm Output

An alarm output refers to sirens linked to a radar. It flashes or generates alarm sound when an alarm or pre-alarm is triggered if you enable it.

Operation: click **Radar Settings** → **Alarm Output** after entering editing mode. Select a relay, and switch on  in the Operation column; or click **Enable All** to enable all the relays in the list.

## Target Number Display

After exiting the editing mode, Move your cursor on the radar's icon to show the number of person, vehicle and other target.

## Display 3D Detection Area

Move your cursor on the radar's icon in the editing mode, click **3D** to enter the view page of detection area. You can click on different direction of the Radar's 3D view to adjust the display angle.



### Note

This function should be supported by the device.

---

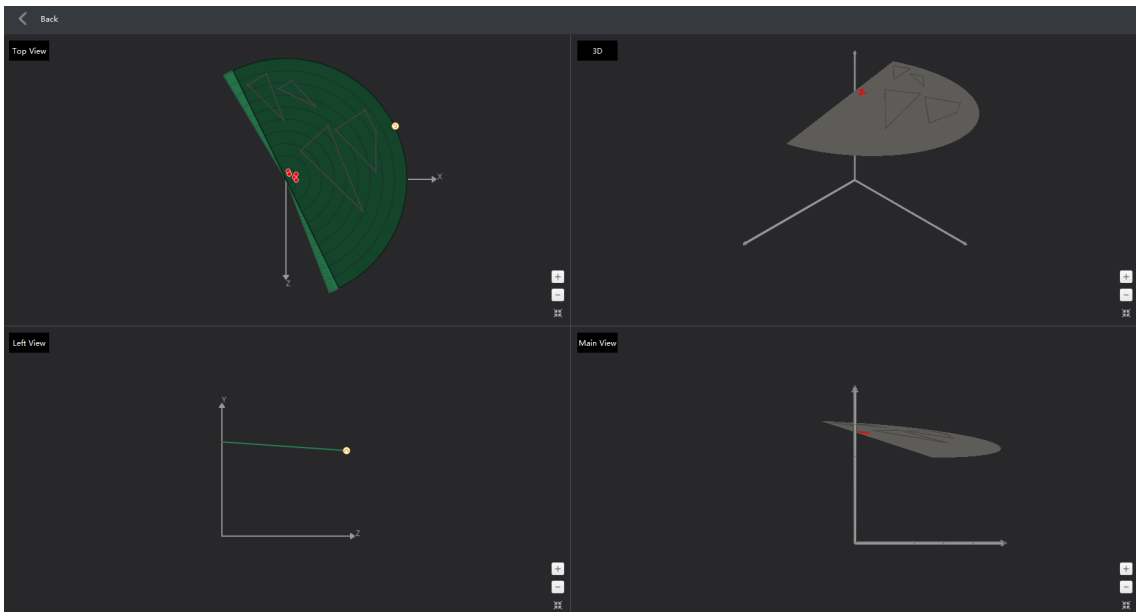

**Figure 9-33 3D Detection Area View**

## Display 3D Detection Area View

Move your cursor on the radar's icon in the non-editing mode, click **3D** to enter the view page of detection area, including 3D view, original point cloud diagram, laser beam diagram, and background outline.

---

### **Note**

- You can click different direction of the Radar's 3D view to adjust the display angle.
- On the original point cloud diagram, you can switch on **Environment Information** on the top-right corner to view the added point cloud filter zone. For details about drawing the point cloud filter zone, refer to [\*\*\*Add Point Cloud Filter Zone\*\*\*](#) .

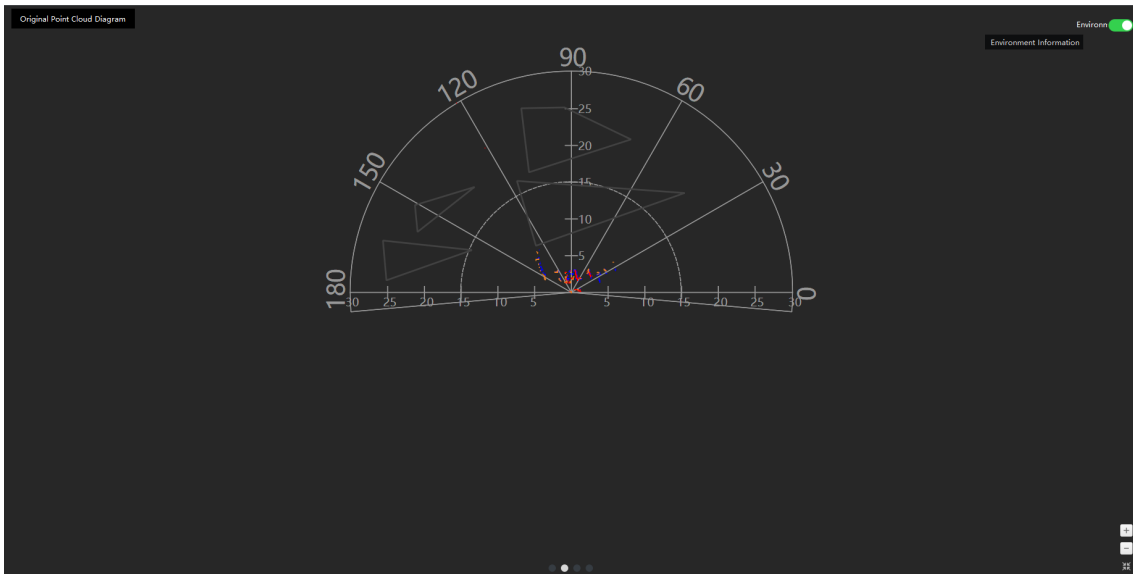

Figure 9-34 Original Point Cloud Diagram

---

## Pattern Playback

After exiting the editing mode, click the radar and then click **Event** to enter the Event Search window on the right. You can search for the event according to the conditions you set, including time period and the zone. The pattern playback video will be played in the middle of the page.

### Note

Make sure the PTZ camera has been linked to the radar.

---

## Display OSD

On the top of the map, click **Display** → **Display OSD** to display the detected target No., target's moving speed, distance and duration between the target and radar.

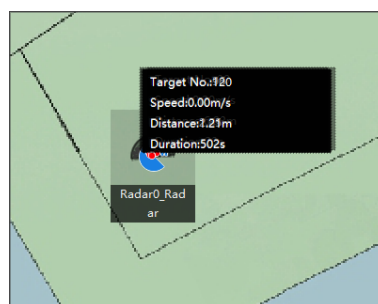

Figure 9-35 OSD on the Map

---

## Display PTZ Camera's FOV

On the top of the map, click **Radar Settings** → **Camera FOV** to display the linked PTZ camera's filed of view (FOV) and camera's IP address on the map.

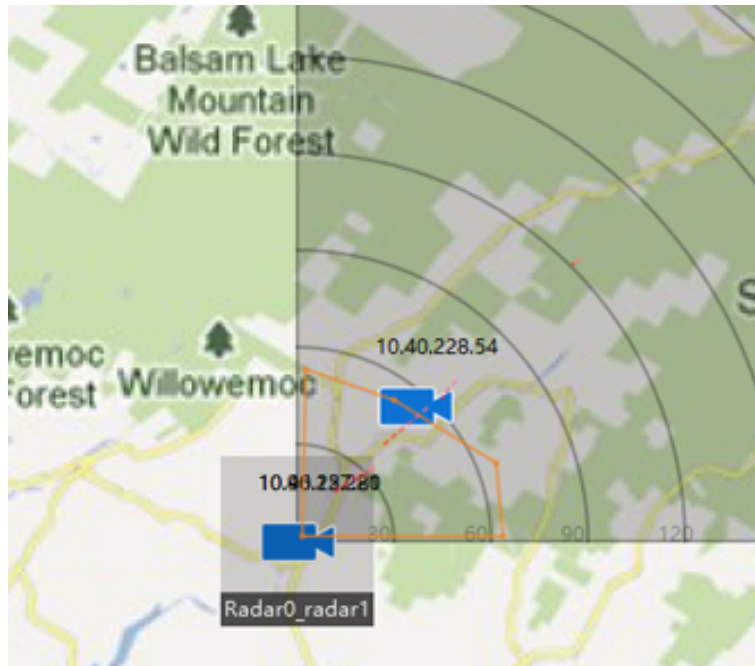

Figure 9-36 PTZ Camera's Field of View

## Refresh

Click **Radar Settings** → **Refresh** on the top of the map to refresh the radar's newest detection angle, detection distance, trigger lines, and arming status.

## 9.4.7 Edit Hot Spot

You can edit the information of the added hot spots on the map, including the name, the color, the icon, etc.

### Steps

1. Enter the E-map module.
2. Click **Edit** in the upper-right corner to enter the map editing mode.
3. Select the hot spot icon on the map and then click  to open the Edit Hot Spot window.
4. Edit the hot spot name in the text field, select the hot spot name's color and hot spot icon shown on the map.
5. Check **Apply to Other Camera Hot Spots/Apply to Other Alarm Input Hot Spots/Apply to Other Alarm Output Hot Spots/Apply to Other Zone Hot Spots** to apply the color and icon settings to other hot spots.

6. Click **OK**.

7. **Optional:** Select the hot spot icon and click  to delete the hot spot.

### 9.4.8 Preview Hot Spot

After adding hot spots (including camera, alarm input/output, zone, security radar, and zone) to the map, you can view the live view of the camera hot spot and the triggered alarm information of all the types of hot spots on the map.

#### Before You Start

Make sure you have added hot spots to the map. See [Manage Hot Spot](#) for details.

#### Steps

1. Enter the E-map module.



If you are in the editing map mode, click **Exit** on the upper-right corner to enter the map preview mode.

2. Click **Display** to show the hot spots on the map.



Hot spot type with  will be shown on the map.

3. Click a hot spot to perform the following operation(s).

**Hot Spot Type**

Operations

**Camera**

Live View: Click  to pop up the live view window of the camera.



- When an alarm is triggered during live view, the client will play a video file of 30 s first.
- You can capture, start recording and instant playback during live view.

**Alarm Output**

Click an alarm output, and select **Open/Close**.



The security control channels managed by the alarm output will also be opened/closed.

**Access Point**

View door status: the current door status of the access point is displayed on the icon. Click the icon to switch the door status.

**Open Door**

When the door is locked, unlock it and it will be open for once. After the open duration, the door will be closed and locked again automatically.

### **Close Door**

When the door is unlocked, lock it and it will be closed. The person who has the access authorization can access the door with credentials.

### **Remain Open**

The door will be unlocked (no matter closed or open). All the persons can access the door with no credentials required.

### **Remain Closed**

The door will be closed and locked. No person can access the door even if he/she has the authorized credentials, except the super users.

### **Security Radar**

Arm/Disarm zones in the monitoring field of the radar: After exiting editing, click the icon of a security radar, and then select **Arm/Disarm**; or click **Event** to search events triggered during certain time range.

---



### **Note**

- You can still arm the radar even if there is a target in the radar's detection area.
  - The warning zone and early warning zone will be armed after arming the radar, which means an alarm will be triggered and reported to the Event Center once a target enters the warning zone and early warning zone.
-

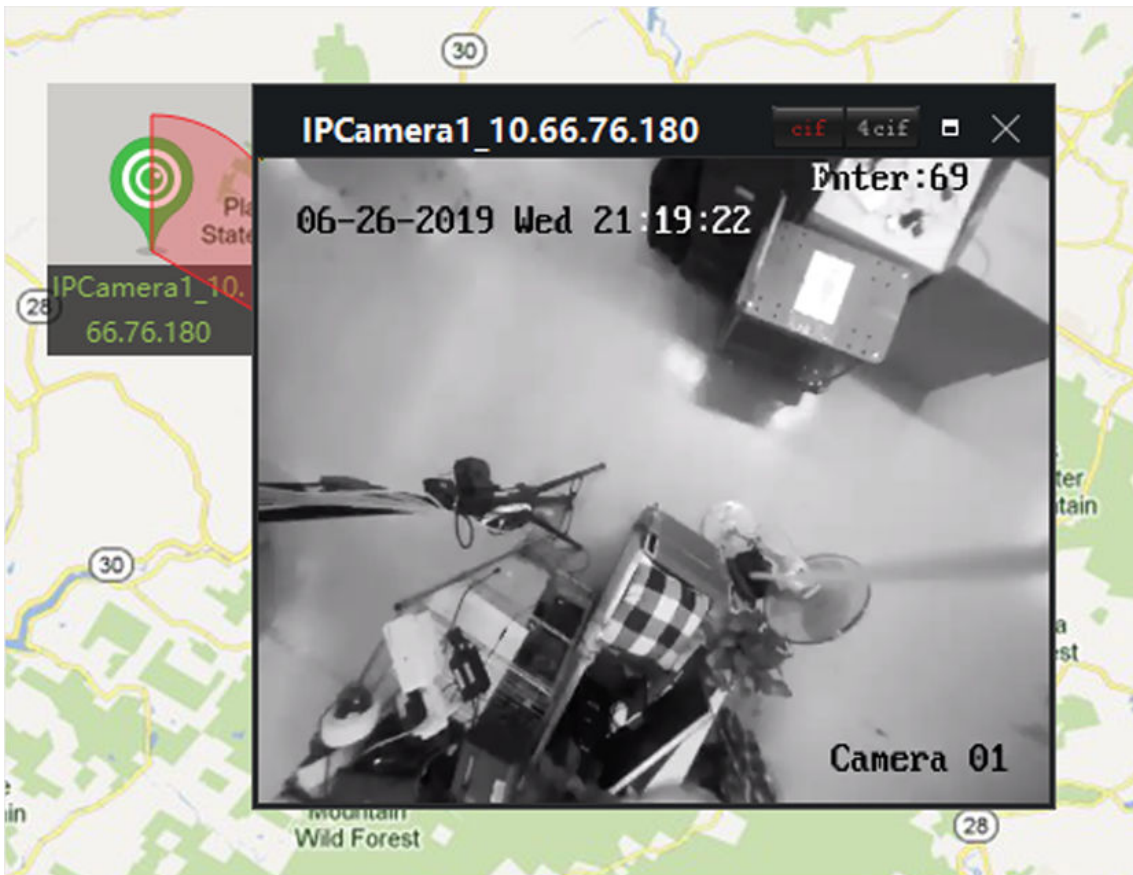

Figure 9-37 Live View of Camera on the Map

4. **Optional:** Perform the following operation(s).

**View Alarm Information**

Click the alarm number on a hot spot icon to open the alarm information page to view the alarm type and triggering time.

**Clear Alarm**

Click **Clear Alarm** on the top of the map to mark all the alarms of the hot spot as read.

**View Multiple Cameras' Live View on the Map**

- a. Click **Live View** to show 4 small windows on the bottom of the client.
- b. Drag a camera from the device list to a window to start the live view.

---

 **Note**

Up to 4 cameras' live view is supported at the same time.

---

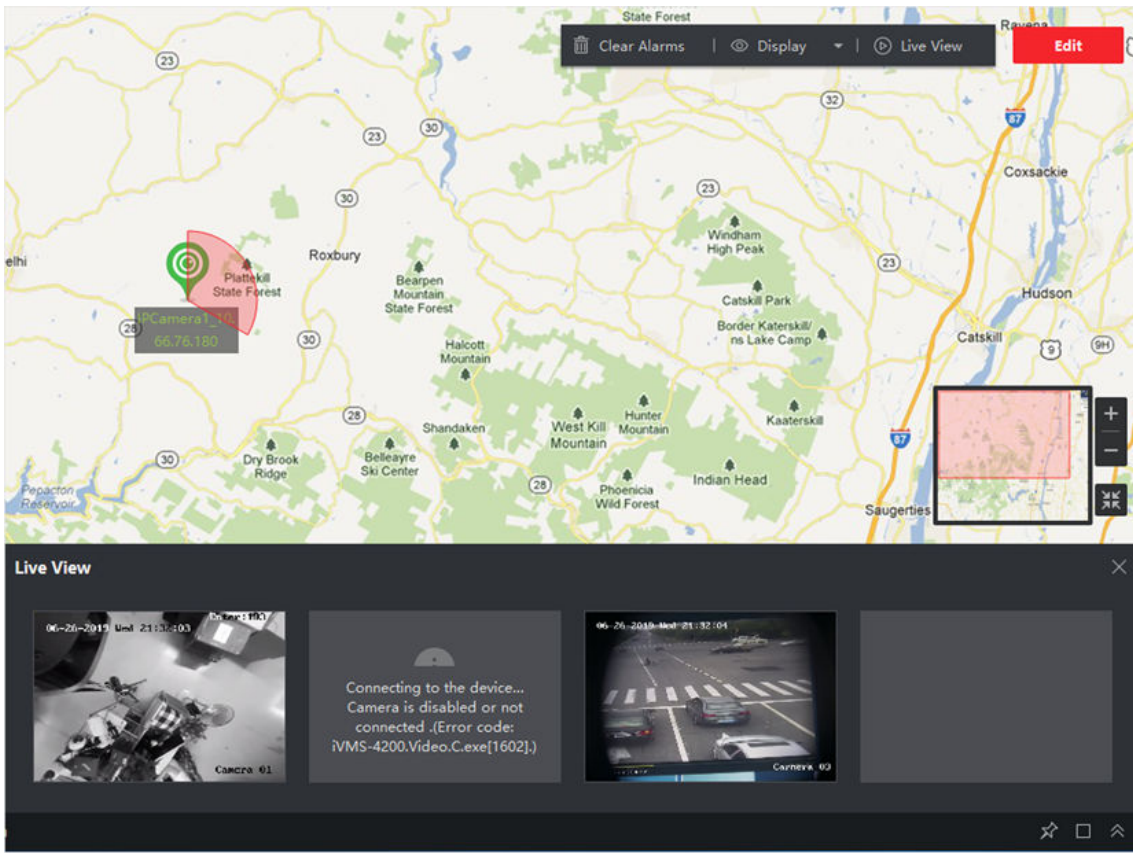

Figure 9-38 Preview Camera Hot Spot

## 9.5 Manage Hot Region

The hot region function links a map to another map. When you add a map to another map as a hot region, an icon of the link to the added map is shown on the main map. The added map is called child map while the map to which you add the hot region is the parent map.

After linking a child map to a parent map, a hot region icon will display on the parent map. You can click it to enter the child map to view the resources on the child map for convenience.

With the function of hot region, e-maps can be organized into hierarchies to navigate from large perspectives to detailed perspectives, e.g., from floor level to room level.

### 9.5.1 Add Hot Region

You can add a map to another map as a hot region and an icon of the link to the added map is shown on the main map. The added map is called child map while the map to which you add the hot region is the parent map.



## Before You Start

At least two maps should be added. Refer to **Add Map** for details about adding maps.

## Steps

---



A map can only be added as the hot region for once.

---

1. Enter the E-map page.
2. Click **Edit** on the upper-right corner to enter the map editing mode.
3. Select an added map as the parent map.
4. Click **Add Hot Region** to open the Add Hot Region window.
5. Select the child map.
6. **Optional:** Edit the hot region name, and select the hot region color and icon by double-clicking the corresponding field.
7. Click **OK**.

The child map icons are added on the parent map as the hot regions.

## 9.5.2 Edit Hot Region

You can edit the information of the hot regions on the parent map, including name, color, icon, etc.

### Steps

1. Enter the E-map module.
2. Click **Edit** on the upper-right corner to enter the map editing mode.
3. Select a hot region icon on the parent map and click  to open the Edit Hot Region window.
4. Edit the hot region name in the text field, select the hot region name's color and hot region icon.
5. Check **Apply to Other Hot Regions** to apply the color and icon settings to other hot regions.
6. Click **OK**.

## 9.5.3 Preview Hot Region

After adding a hot region, you can click the hot region icon on the parent map to enter the child map. You can view the resources and alarms on the child map.

### Steps

1. Enter the E-map page.
- 



If you are in the editing map mode, click **Exit** on the upper-right corner to enter the map preview mode.

---

2. Click the hot region icon on the parent map to enter the linked child map.
-

You can view the resources on the child map. If there is any alarm triggered on the child map, you can view the alarm details.

- 3. Optional:** Click **Back to Parent Map** on the upper-left corner to go back to the parent map.
- 4. Optional:** Click **Clear Alarm Info.** on the upper-right corner to clear the alarm information triggered by the resources on the current map.

### 9.6 View Person's Moving Pattern

With the help of facial recognition devices, you can view the target person's moving pattern on the map, which is generated by several cameras' locations. E-map allows you to search and view the moving pattern of an individual (such as a suspect, a missing child, etc.) on the map to help finding him/her.

#### Before You Start

Make sure you have added a map for a group and added the cameras in the group to the map. See [Add Map](#) and [Add Camera as Hot Spot](#) for details.

#### Steps

1. Enter the E-map module.
2. Click a group name in the resource list on the left column.  
The group's map and resources on the map appear in the display area.
- 3. Optional:** Click **Add Map** to add a map for the group and add cameras in the group to the map.
4. Click **Moving Pattern** on the top of the map to open the Search Moving Pattern page.
5. Click  to set a time period for searching moving pattern.
6. Check face picture analysis device in the list.

---

#### Note

The picture you upload in Step 7 will be compared with pictures stored in the checked devices.

- 7. Click Select Picture** to select a face picture to upload or drag a picture to the picture area.

---

#### Note

You can upload a picture containing multiple face pictures from which you need to select one for comparison.

- 8. Drag the slider or enter a number to select a similarity.**

---



#### Note

The client will search face pictures stored in the selected face picture analysis devices whose similarity with the uploaded picture is higher than the configured similarity, and then display the moving pattern of the matched person on the map.

- 9. Click Search.**

Moving pattern of the person who is similar to the uploaded picture is displayed on the map, the cameras captured pictures will be numbered showing the person's arriving order, and the capture records will be displayed on the left with the captured picture thumbnail displayed also.

**10. Optional:** Perform the following operation(s) after searching moving pattern.

Operation	Description
<b>Filter Capture Records</b>	Click  and check <b>Show Last Record</b> to show the last record of every camera through the moving pattern.
<b>View Person Related Videos and Pictures</b>	Click a captured picture thumbnail to open the Capture Details window and you can view the detailed information of the picture you clicked. All pictures of the person captured by the camera will be displayed on the right. Select a captured picture to show its related video of 10 seconds on the left, including the 5 seconds before the capturing time and the 5 seconds after the capturing time. Click  to start displaying the video.
<b>Disable Pattern</b>	Click  on the top of the record list or <b>Disable Pattern</b> to exit moving pattern mode.

## Chapter 10 Statistics

Reports, created for a specified period, are essential documents, which are used to check whether a business runs smoothly and effectively. In this software, reports can be generated daily, weekly, monthly, annually, and by custom time period. You can use reports as basis in creating decisions, addressing problems, checking tendency and comparison, etc.

### 10.1 People Counting Report

People counting statistics is to calculate the number of line crossing people in a specific area and a certain time period by the people counting camera(s) or behavior analysis server(s), which can help the storekeeper to analyze the customers flow and number in different time, and the storekeeper can flexibly do some business adjustment according to the report.

#### 10.1.1 People Counting Report by Encoding Device

People counting report by encoding device displays people counting data collected by encoding devices. You can search the people counting data in different dimensions.

##### Before You Start

Add an encoding device with people counting function to the software and properly configure the corresponding area and people counting rule. Refer to **Add Device** for details about adding people counting device.

##### Steps

1. Click **Report** → **People Counting** to enter People Counting page.
2. Select **Encoding Device** as the **Device Type**.
3. Select daily report, weekly report, monthly report, or annual report as the report type.

##### Daily Report

Daily report shows data on a daily basis. The system will calculate the number of people in each hour of one day.

##### Weekly Report, Monthly Report and Annual Report

As compared to daily report, weekly report, monthly report and annual report can be less-time consuming, since they are not to be submitted every day. The system will calculate the number of people in each day of one week, in each day of one month, in each month of one year.

##### Custom Report

Users can customize the days in the report to analyze the number of people in each day or month of the custom time interval.

---

 **Note**

You can select no more than 31 days on the calendar.

- 
4. Select the statistics time type and click  to set the time.

### One Period

Generate the statistics in one time period.

### Multiple Periods

Generate the statistics in two time periods, which can help you to compare the people flow and number in two time periods.

For example, if you set the report type as month report, and set the March and April as the statistic time, the people counting results in March and April will be displayed in a same chart with different color, and you can compare the data in different day of each month.

5. Select **Statistics Type**.

### Display by Device

Display the report by device.

For example, if you select one NVR (with 4 people counting cameras), the report will display the total number of people summed by the 4 people counting cameras.

### Display by Camera

Display the report by camera.

For example, if you select one NVR (with 4 people counting cameras), the report will display the each camera's statistics respectively, namely display the statistics in 4/8 colors (each one or two colors representing one camera).

### Display by Grouping Statistics

Display the report by grouping statistics.

For example, if you select one device group (the group is created on the Client), the report will display the total number of people summed by the total people counting cameras in the group.

---

 **Note**

- For details of device group, refer to [\*\*\*Group Resources\*\*\*](#) .
- This function should be supported by the device.

- 
6. Select filtering mode.

### Channel

Display people counting data collected by channels of an encoding device.

### Region

Display number of people in selected regions of a camera.

## Note

You need to configure regions for the camera beforehand. See user manual of the device for details.

7. Select camera(s) or region(s) from the **Camera** list.
8. Set the content to be displayed.

### Direction

Calculate the number of people in different directions, such as enter, exit, or enter and exit.

#### Enter

The people entered will be counted.

#### Exit

The people exited will be counted.

#### Enter and Exit

Both people entered and exited will be counted.

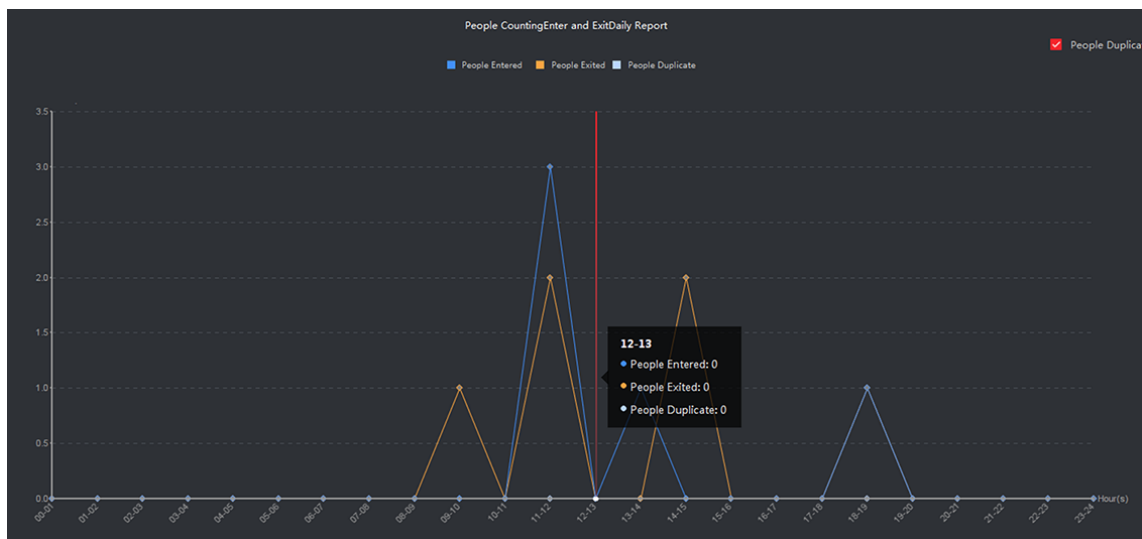
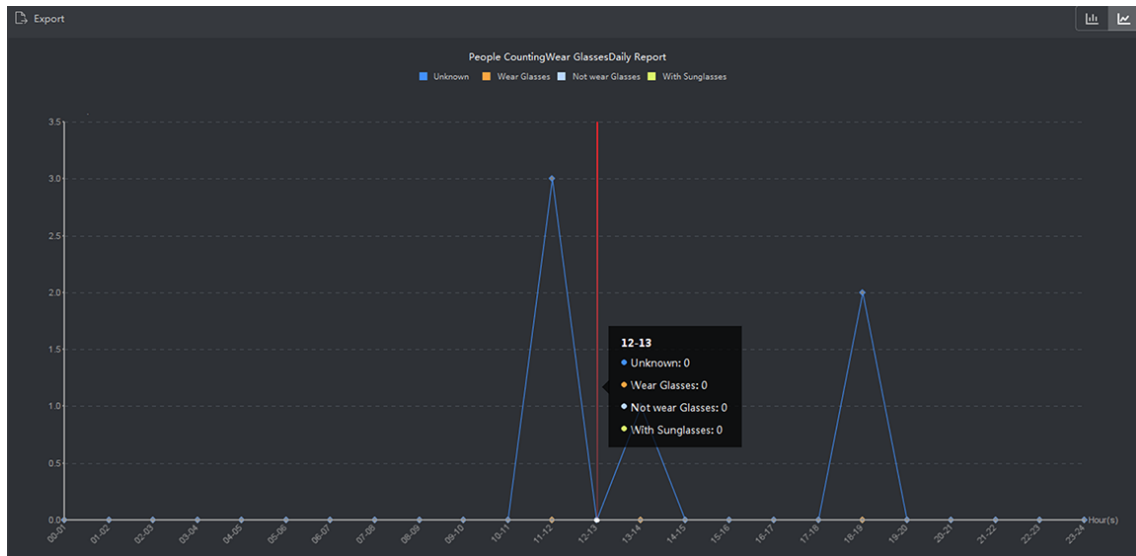

Figure 10-1 People Counting by Direction

### Facial Features

Generate the report based on the facial feature, such as **Gender, Age Group, Age Group**.

For example, if you select **Age Group** as the facial feature, the client will calculate the number of people in different age group.



**Figure 10-2 People Counting by Facial Features**

**9. Optional:** Check **Children Only** to generate report of recognized children.

**Note**

- The client counts detected people shorter than a predefined height which can be configured on device's remote configuration page. See the device user manual for details about configuring height threshold.
- This function needs to be supported by the device.

**10.** Click **Search** to get the people counting statistics and detailed data for each hour, day, or month.

By default, the statistics are shown in histogram form.

**11. Optional:** For the report by direction, you can check **People Duplicate** on the right-upper corner of the report page to display the number of duplicate people.

**Note**

The number of duplicate people is calculated by the device. If the same face is recognized more than once, he/she will be calculated as duplicate person.

For example, if a cashier enter or exit the supermarket more than once, he/she will be calculated as duplicate person. In this way, the supermarket can get the actual number of people shopping.

**12. Optional:** Perform the following operations after search.

**Switch to Line Chart** Click  to switch it to line chart.

**Note**

By default, the statistics are shown in bar chart.

**Switch to Bar Chart** Click  to switch it to bar chart.

**Save to Local PC** Click **Export** to save the detailed data of people counting to your PC.

### 10.1.2 View People Counting Report by DeepinMind Server

People counting data by DeepinMind server are data counted based on predefined calculation rules. Data not conformed to the calculation rules will be omitted in the people counting report. This gives you more accurate people counting data.

#### Before You Start

Add a DeepinMind server to the software and properly configure a calculation rule. See [Add Device](#) for details about adding a DeepinMind server. See the device user manual about configuring calculation rule.

#### Steps

1. Click **Report** → **People Counting** .
2. Select **DeepinMind Server** as the device type.
3. Select hourly report, daily report, monthly report, or annual report as the report type.

#### Hourly Report

Hourly Report can be used for analyzing people counting data generated during peak time.

#### Daily Report

Daily report shows data on a daily basis. The system will calculate the number of people in each hour of one day.

#### Monthly Report and Annual Report

Compared with daily report, monthly report and annual report can be less time consuming, since they are not submitted every day. The system will calculate the number of people in each day of one month and in each month of one year.

4. Click  to select time.
5. Select a calculation rule.
6. Select the content to be displayed.

#### Direction

Calculate the number of people moving in different directions, including enter, exit, and enter & exit.

#### Enter

The number of people entered will be displayed.

#### Exit

The number of people exited will be displayed.

#### Enter and Exit

The number of people entered and exited will be displayed.



7. Click **Search** to get the people counting data of each minute, hour, day, or month.

 **Note**

By default, the report will be shown in a line chart.

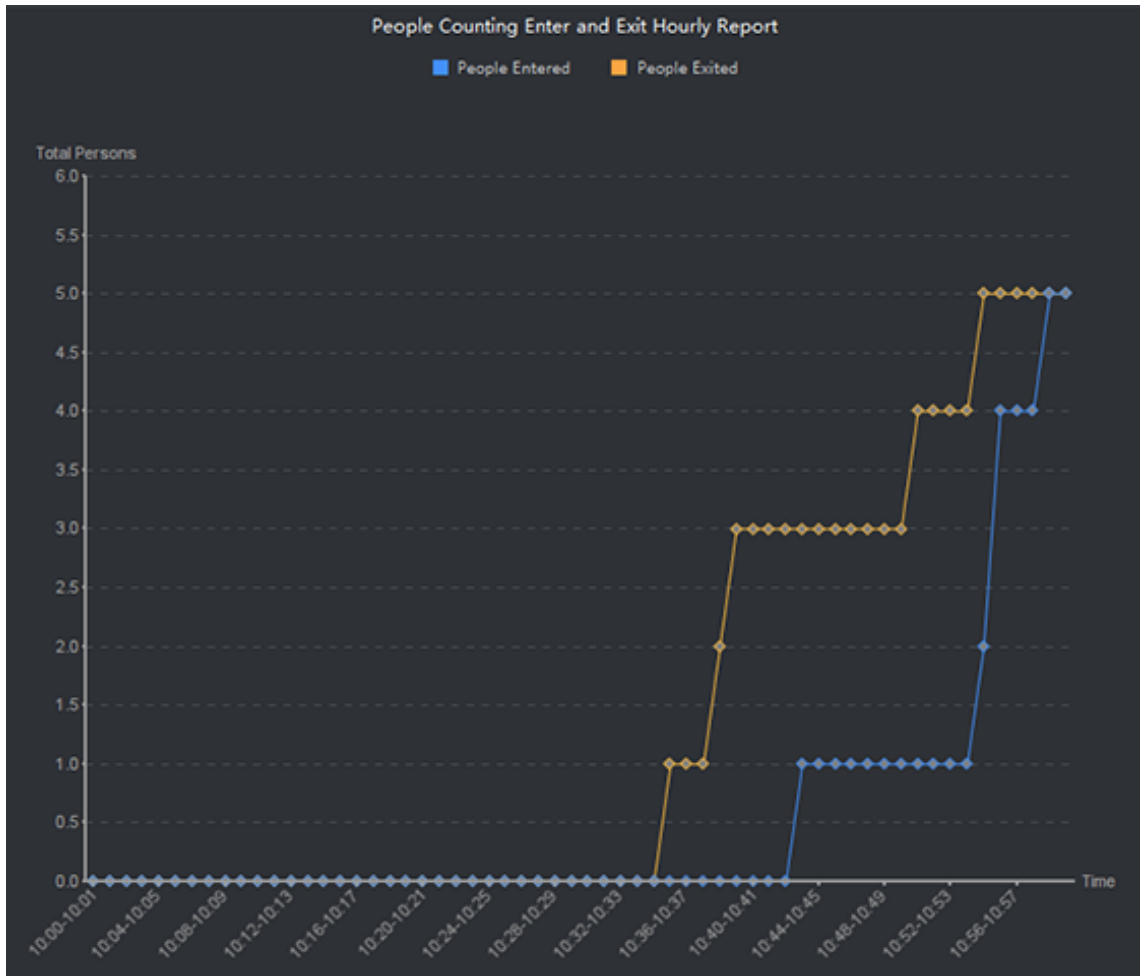

Figure 10-3 People Counting Report by DeepinMind Server

8. **Optional:** Click **Export** to save the report to your PC.

## 10.2 View People Counting in Intersections Report

Intersection analysis is used to monitor people flow and number in an intersection-like scene. The arrows in the image refer to different directions. By selecting one direction (e.g. A) as the entrance, the other directions will be set as the exits by default, so that multiple paths are generated (e.g., A to A, A to B, A to C, and A to D). You can view the people counting who passed by each path, respectively, which can help the shopkeeper to analyze the people flow in different door. The statistics result can show in daily, weekly, monthly, and annual report.

**Before You Start**

Make sure a fisheye camera which supports intersection analysis function has been configured properly and be added to the software. Refer to **Add Device** for details about adding the device.

**Steps**

**Note**

Up to 10 intersections can be analyzed.

1. Click **Report** → **Intersection Analysis** to enter the intersection analysis module.
2. Select daily report, weekly report, monthly report, or annual report as the report type.

**Daily Report**

Daily report shows data on a daily basis. The system will calculate the number of people in intersection report in a each hour of one day.

**Weekly Report, Monthly Report and Annual Report**

As compared to daily report, weekly report, monthly report and annual report can be less-time consuming, since they are not to be submitted every day. The system will calculate the number of people in intersection report in each day of one week, in each day of one month, in each month of one year.

3. Set the start time for the report.
4. Select the camera for generating the report.
5. Select one direction as the entrance from the drop-down list in the **Flow in** filed.
6. Click **Search** to get the statistics result.

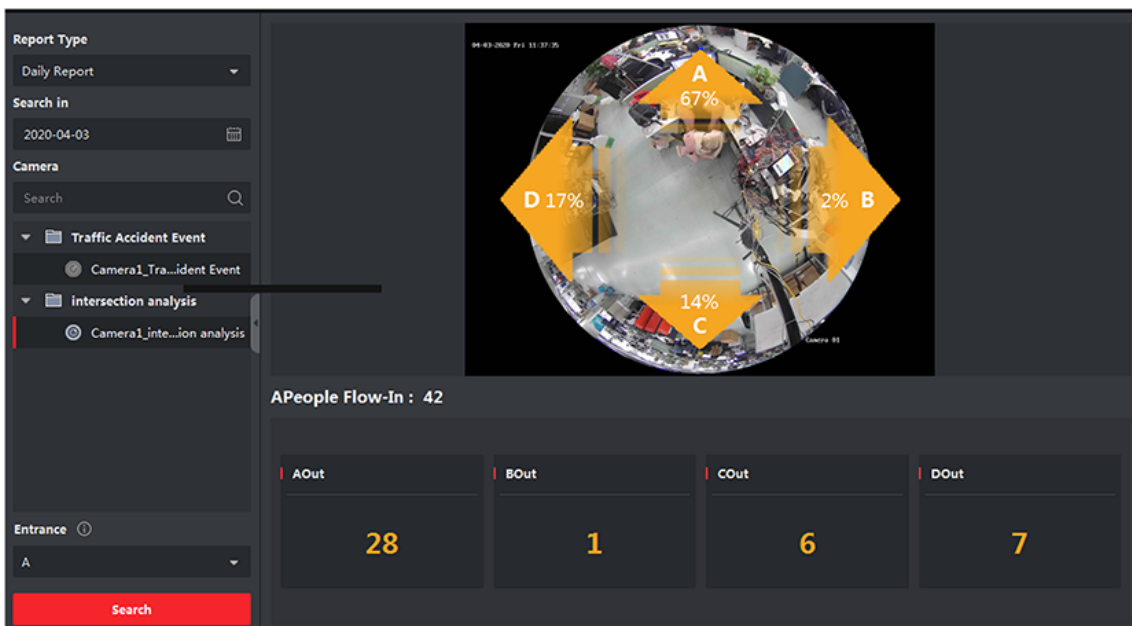

**Figure 10-4 Results**

The people number for each path will show on the right.

## 10.3 Queue Management

Queue management supports data analysis and report output from multiple dimensions.

### Commonly Used Data Analysis

- To see queuing-up people number of a certain waiting time level in a queue/region, use queuing-up time analysis, check a target region and set a waiting time level.
- To compare queuing-up people number of a certain waiting time level in multiple queues/regions, use queuing-up time analysis, check target regions and set a waiting time level.
- To compare queuing-up people number of different waiting time levels in multiple queues/regions, use queuing-up time analysis, check target regions and set waiting time levels.
- To see the time and duration that a queue stays a certain length in a queue/region, use queue status analysis, check a target region and set a queue length level.
- To compare the time and duration that a queue stays a certain length in multiple queues/regions, use queue status analysis, check target regions and set a queue length level.
- To compare the time and duration that a queue stays at different length in multiple queues/regions, use queue status analysis, check target regions and set queue length levels.

### 10.3.1 Queuing-Up Time Analysis

Queuing-Up Time Analysis calculates people number of different waiting time levels. Regional comparison and multiple waiting time level comparison are supported.

### Compare Queuing-up People Amount for Different Regions

With cameras for queuing-up people amount counting, you can search the queuing-up people amount during time period of certain length in different regions, helping the storekeeper to find areas where customers tend to go. For example, the regions with larger people amount are more popular than the regions with lower people amount, so that you can put goods in these regions to sell more of them.

#### Before You Start

- Add the device to the software and properly configure the corresponding settings. See **Add Device** for details about adding the device.
- Make sure you have configured no more than 3 regions in the detection area of a camera on device remote configuration page. See device user manual for details about configuring regions.

#### Steps



This function should be supported by the connected device.

---

1. Click **Report** → **Queue Management** → **People Amount in Region** .

2. Select **Daily Report/Weekly Report/Monthly Report/Custom Report** as the report type.

### **Daily Report**

Daily report shows data on a daily basis. The system will calculate the queuing-up duration for different regions in a each hour of one day.

### **Weekly Report, Monthly Report**

As compared to daily report, weekly report and monthly report can be less-time consuming, since they are not to be submitted every day. The system will calculate the queuing-up duration for different regions in each day of one week, in each day of one month.

### **Custom Report**

Users can customize the days in the report to analyze the number of people on each day or month of the custom time interval.



### **Note**

You can select no more than 31 days on the calendar.

---

3. Click  to set time period for searching.
4. Select cameras and no more than 3 regions for every camera in the **Region** list.
5. Select **Regional Comparison** as the statistics type.
6. Select a waiting time level based on which the report is generated.
7. Click **Search** to generate the statistics result.

The line chart of the calculated people amount in the specified waiting time will show on the result area. The lines with different colors indicate the people from the selected regions.

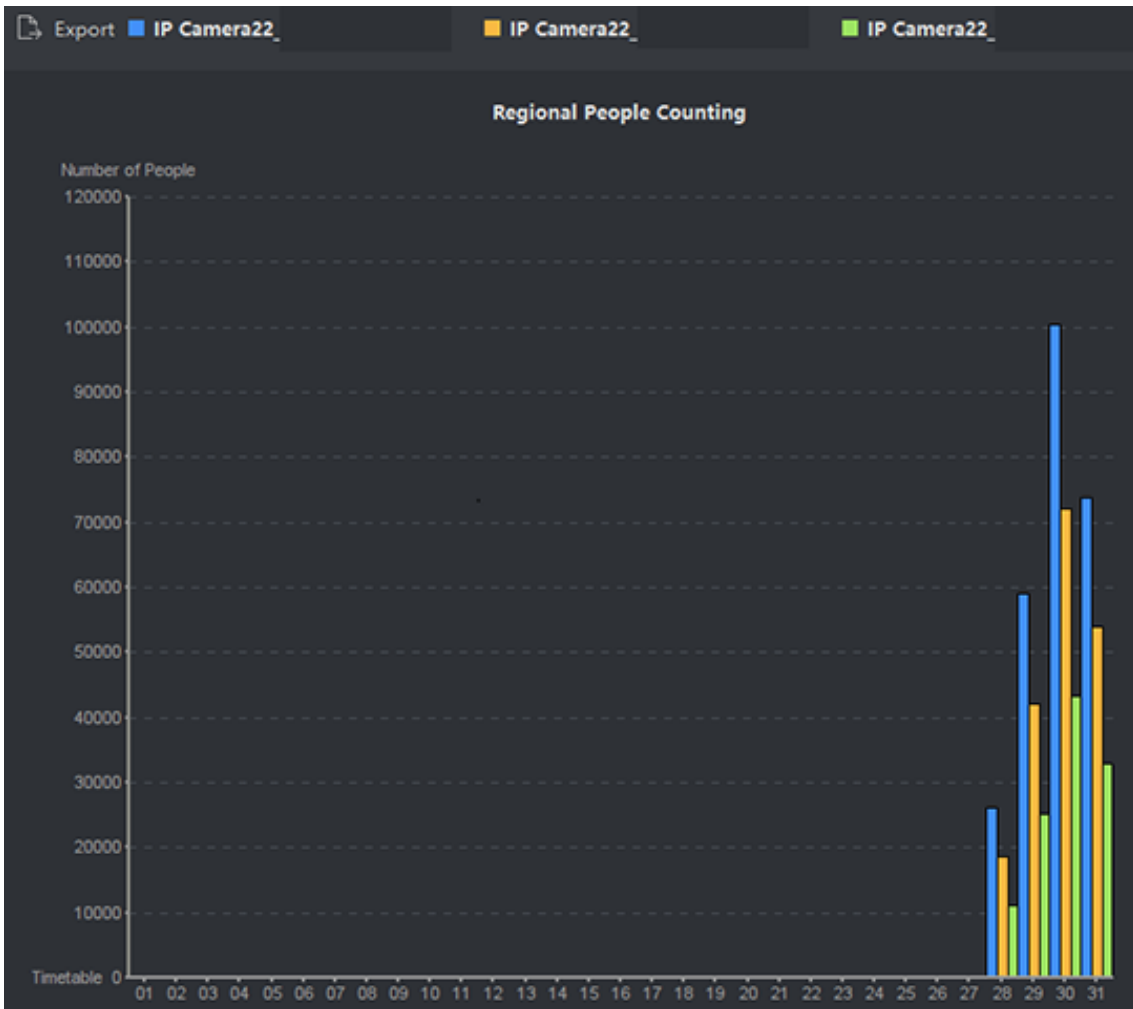

Figure 10-5 Result

8. Optional: Click **Export** to export the data in Excel file.

### Compare Queuing-up People Amount for Different Waiting Time Levels

With cameras for queuing-up people amount counting, you can search the queuing-up people amount during time periods of different length in a certain region, helping analyzing perception of crowding in different regions to make it easy to know when and how to change service window amount, staff amount, and whether to set a guider for people, etc.

#### Before You Start

- Add the device to the software and properly configure the corresponding settings. See **Add Device** for details about adding the device.
- Make sure you have configured no more than 3 regions in the detection area of a camera on device remote configuration page. See device user manual for details about configuring regions.

## Steps

---

### Note

This function should be supported by the connected device.

---

1. Click **Report** → **Queue Management** → **Regional People Counting** .
2. Select **Daily Report/Weekly Report/Monthly Report/Custom Report** as the report type.

#### **Daily Report**

Daily report shows data on a daily basis. The system will calculate the queuing-up duration for different regions in a each hour of one day.

#### **Weekly Report, Monthly Report**

As compared to daily report, weekly report and monthly report can be less-time consuming, since they are not to be submitted every day. The system will calculate the queuing-up duration for different regions in each day of one week, in each day of one month.

#### **Custom Report**

Users can customize the days in the report to analyze the number of people on each day or month of the custom time interval.

---

### Note

You can select no more than 31 days on the calendar.

---

3. Click  to set time period for searching.
4. Select cameras and no more than 3 regions in the **Region** list.
5. Select **Multi-Level Comparison** as the statistics type.
6. Select the waiting time level and enter the seconds for calculating people amount waiting for the specified time period.
7. Click **Search** to generate the statistics result.

The line chart of the calculated people amount in the same region will show on the result area. The lines with different colors match the waiting time levels.

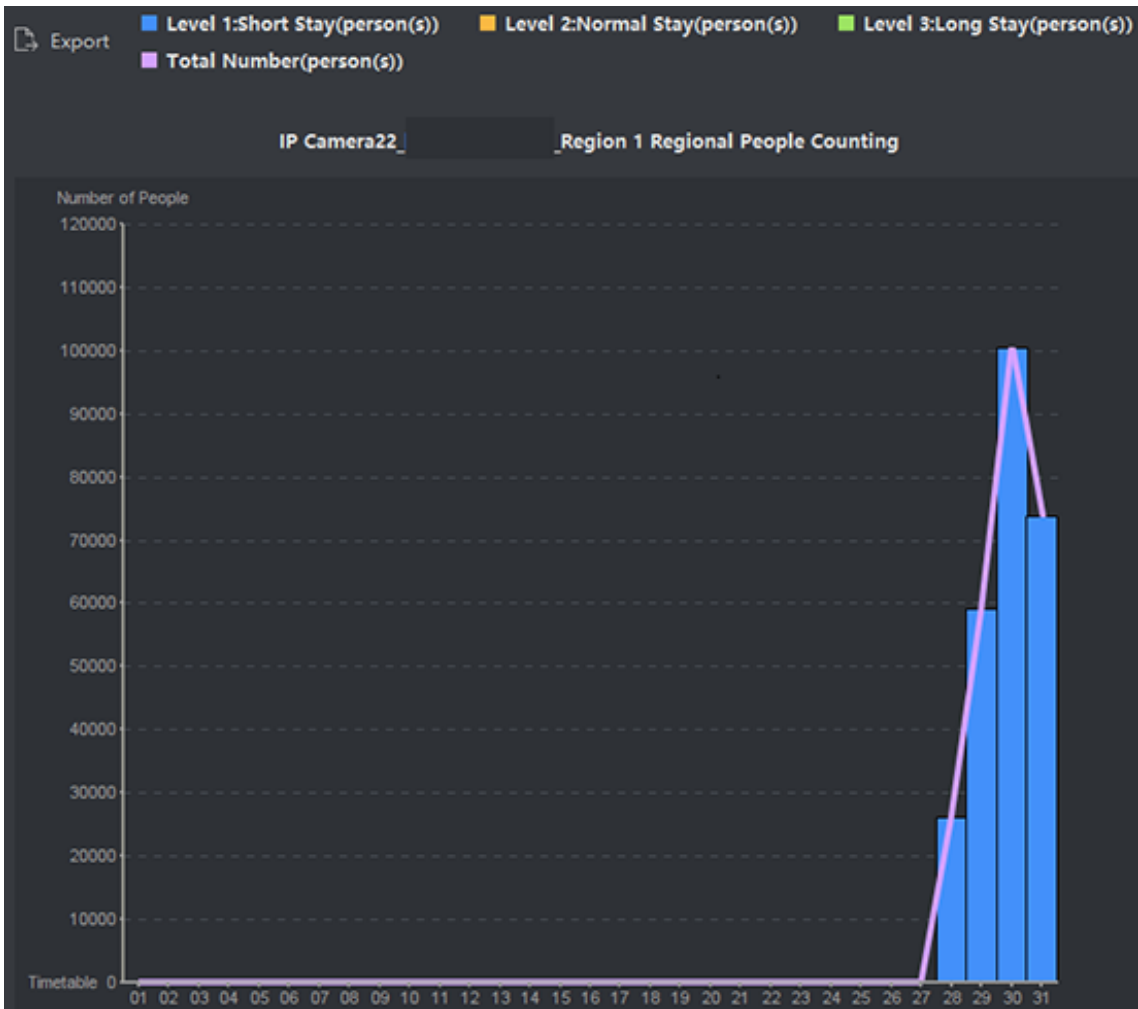

Figure 10-6 Result

8. Optional: Click **Export** to export the data in Excel file.

### 10.3.2 Queue Status Analysis

Queue Status Analysis calculates the time and duration that a queue stays with a certain length. Regional comparison and multiple queue length level comparison are supported.

#### Compare Queuing-up Duration for Different Regions

With cameras for queuing-up duration counting, you can search and compare the queuing-up durations in different regions during the same time period, helping analyzing perception of crowding in different regions to make it easy to know when and how to change service window amount, staff amount, and whether to set a guider for people, etc.

## Before You Start

- Add the device to the software and properly configure the corresponding settings. See **Add Device** for details about adding the device.
- Make sure you have configured no more than 3 regions in the detection area of a camera on device remote configuration page. See device user manual for details about configuring regions.

## Steps

---

### Note

This function should be supported by the connected device.

---

1. Click **Report** → **Queue Management** → **Waiting Duration** .
2. Select **Daily Report/Weekly Report/Monthly Report/Custom Report** as the report type.

### Daily Report

Daily report shows data on a daily basis. The system will calculate the queuing-up duration for different regions in a each hour of one day.

### Weekly Report, Monthly Report

As compared to daily report, weekly report and monthly report can be less-time consuming, since they are not to be submitted every day. The system will calculate the queuing-up duration for different regions in each day of one week, in each day of one month.

### Custom Report

Users can customize the days in the report to analyze the queuing-up duration on each day or month of the custom time interval.

---

### Note

You can select no more than 31 days on the calendar.

---

3. Click  to set time period for searching.
4. Select cameras and no more than 3 regions for every camera in the **Region** list.
5. Select **Regional Comparison** as the statistics type.
6. Set the length of queue based on which the report is generated.
7. Click **Search** to generate the statistics result.

The line chart of the calculated duration for staying the specified queue length will show on the result area. The lines with different colors match the selected regions.



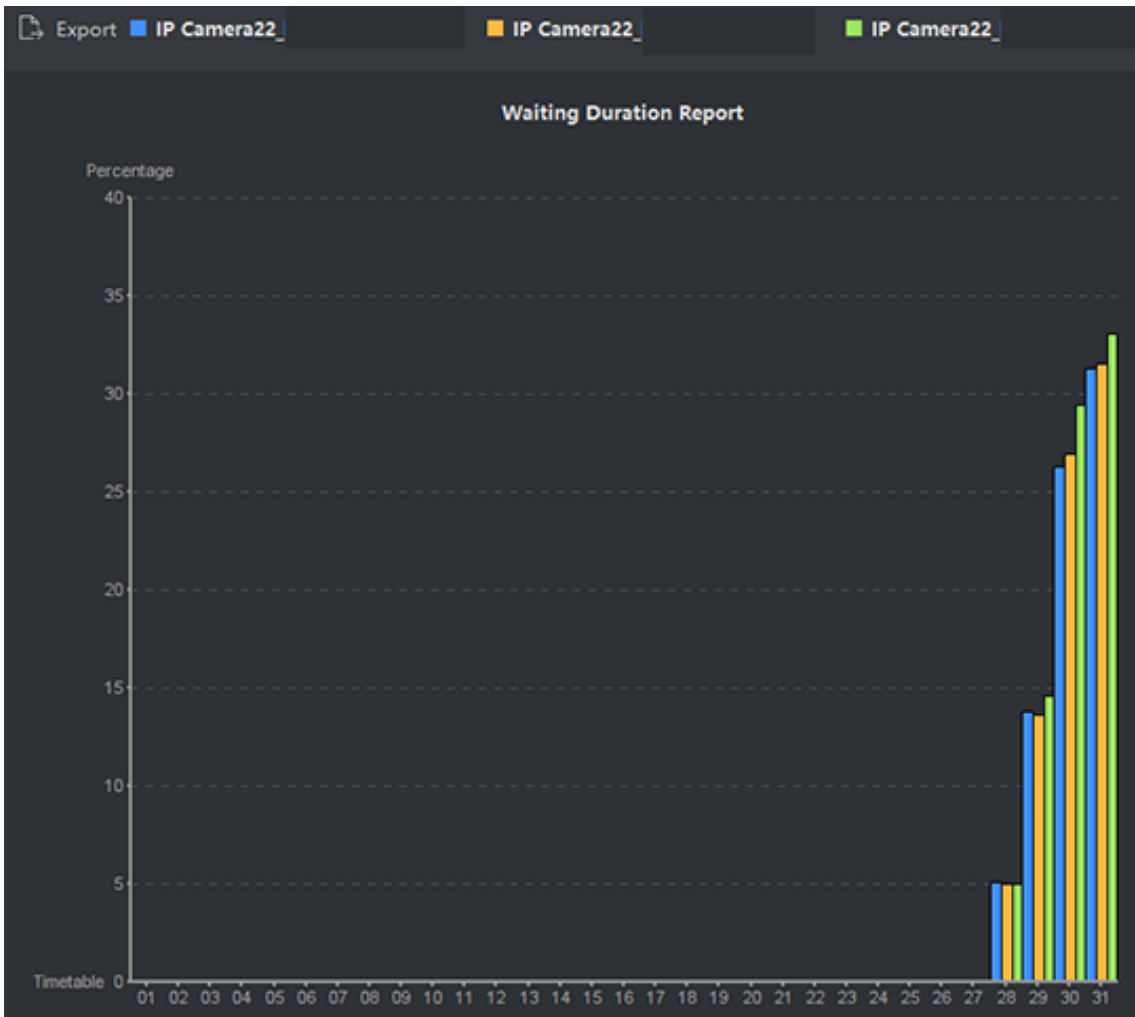

Figure 10-7 Result

8. **Optional:** Click **Export** to export the data in Excel file.

### Compare Queuing-up Duration for Different Queue Length Levels

With cameras for queuing-up duration counting, you can search and compare the queuing-up durations of queues of different length during the same time period, helping analyzing perception of crowding in different regions to make it easy to know when and how to change service window amount, staff amount, and whether to set a guider for people, etc.

#### Before You Start

Add the device to the software and properly configure the corresponding settings. See [Add Device](#) for details about adding the device.

## Steps

---

### Note

This function should be supported by the connected device.

---

1. Click **Report** → **Queue Management** → **Waiting Duration** .
2. Select **Daily Report/Weekly Report/Monthly Report/Custom Report** as the report type.

#### **Daily Report**

Daily report shows data on a daily basis. The system will calculate the queuing-up duration for different regions in a each hour of one day.

#### **Weekly Report, Monthly Report**

As compared to daily report, weekly report and monthly report can be less-time consuming, since they are not to be submitted every day. The system will calculate the queuing-up duration for different regions in each day of one week, in each day of one month.

#### **Custom Report**

Users can customize the days in the report to analyze the queuing-up duration on each day or month of the custom time interval.

---

### Note

You can select no more than 31 days on the calendar.

---

3. Click  to set time period for searching.
4. Select cameras and no more than 3 regions in the **Region** list.
5. Select **Multi-Level Comparison** as the statistics type.
6. Set the length of queue based on which the report is generated.
7. Click **Search** to generate the statistics result.

The line chart of the calculated duration in the same region will show on the result area. The lines with different colors match the queue length levels.

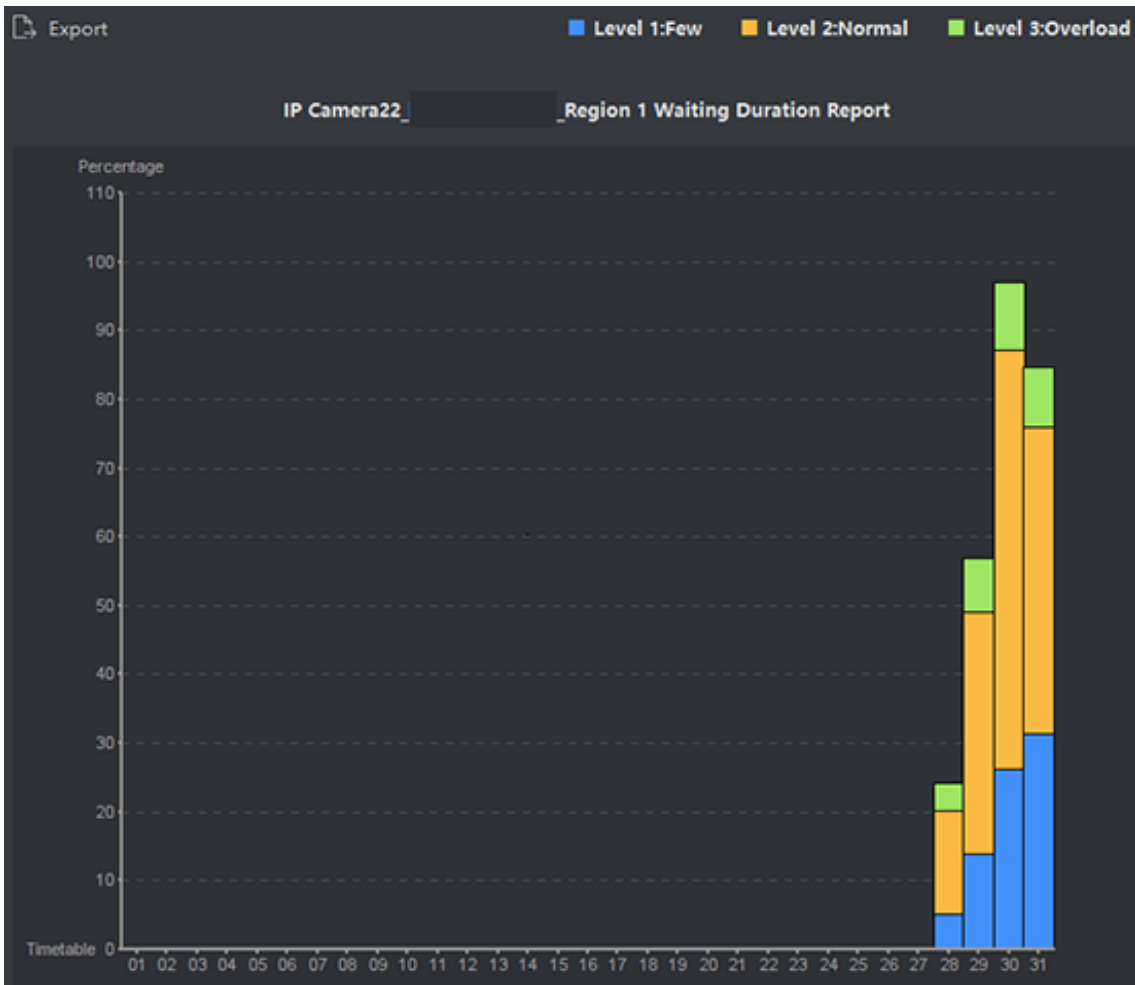

Figure 10-8 Result

8. **Optional:** Click **Export** to export the data in Excel file.

## 10.4 Heat Map Report

Heat map is a graphical representation of data represented by colors and the heat map data can be displayed in line chart. You can use the heat map function of the camera to analyze the visit times and dwell time of customers in a configured area, which can help the storekeeper analyze the customers' interested area and make the arrangement of goods.

### Before You Start

Add a heat map network camera to the software and properly configure the corresponding area. The added camera should have been configured with heat map rule. See **Add Device** for details about adding heat map network camera.

## Steps

1. Click **Report** → **Heat Map** to enter the heat map page.
2. Select **Daily Report/Weekly Report/Monthly Report/Annual Report/Custom Report** as the report type.

### Daily Report

Daily report shows data on a daily basis. The system will calculate the data of heat map in a each hour of one day.

### Weekly Report, Monthly Report and Annual Report

As compared to daily report, weekly report, monthly report and annual report can be less-time consuming, since they are not to be submitted every day. The system will calculate the data of heat map in each day of one week, in each day of one month, in each month of one year.

### Custom Report

You can customize the days in the report to analyze the dwell time or crowd trend on each day or month of the custom time interval.



### Note

The time period in the custom report should be no more than 31 days.

- 
3. Select **By Dwell Time** or **By Crowd Trend** as the statistics type.

### By Dwell Time

The system calculates the heat map value (the ordinate value in the line chart or the color in pictures) according to the people's dwell time.

### By Crowd Trend

The system calculates the heat map value (the ordinate value in the line chart or the color in pictures) according to the number of detected people.

4. Set the time period for searching.
5. Select a heat map camera in the camera list.
6. Click **Generate Heat Map** to show the heat map of the camera.

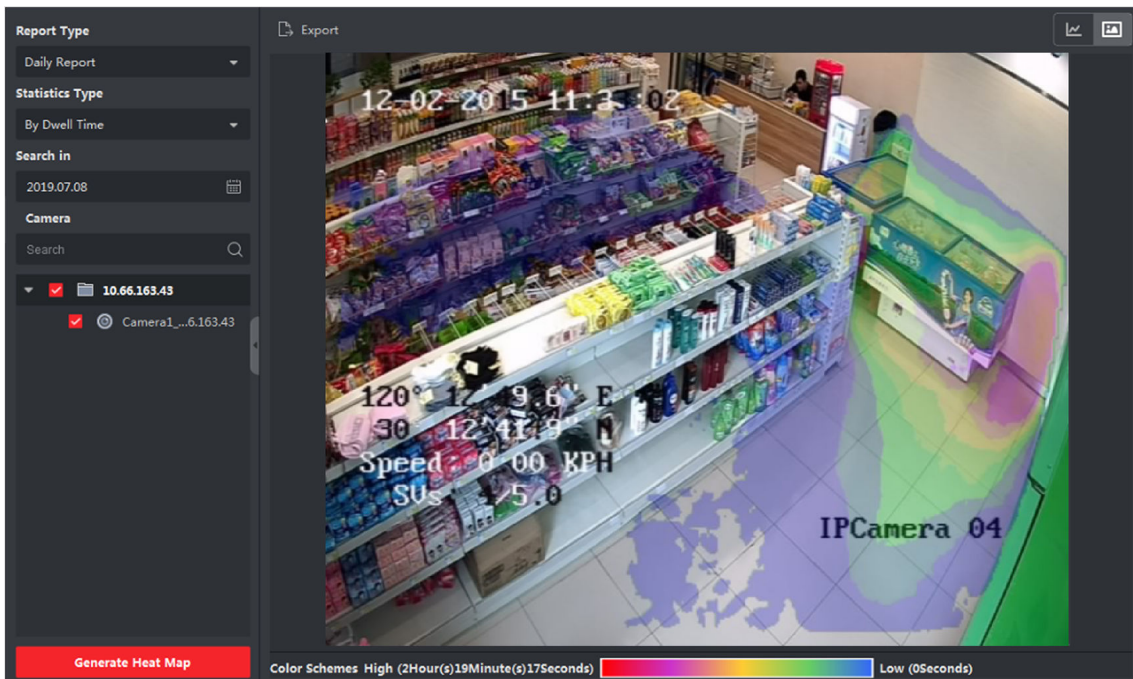



Figure 10-9 Results

**7. Optional:** After generating heat map report, you can perform the following operations.

- Display in Line Chart** Click  to display the statistics in line chart.
- Display in Picture Mode** Click  to display the statistics in picture mode.  
The red color block (255, 0, 0) indicates the most welcome area, and blue color block (0, 0, 255) indicates the less-popular area.
- Save Statistics Data** Click **Export** to save the detailed data of heat map to your PC.

## 10.5 Report of Skin-Surface Temperature Statistics

The system can calculate the total number of people, the number of people whose skin-surface temperature is abnormal and the number of people who do not wear mask. The system provides the statistics report per day, per week and per month, to help you judge the trend of the number of people whose skin-surface temperature is abnormal and the number of people who do not wear mask.

### Before You Start

Add the devices which support skin-temperature measurement, such as the intelligent device with face skin-temperature measurement function.

### Steps

1. Select **Report** → **Skin-Surface Temperature**.

2. Select the report type by the drop-down list, including **Daily Report**, **Weekly Report**, **Monthly Report** or **Annual Report**.
3. Click  to select the time range.
4. Select a camera, device or group.
5. Click **Search**.

Display the report in histogram on the right area.

 **Note**

The **All**、**Abnormal**、**No Mask** and **Normal Skin-Surface Temperature** is displayed on the upper area of the report, you can select the detection attribute(s) to be displayed.

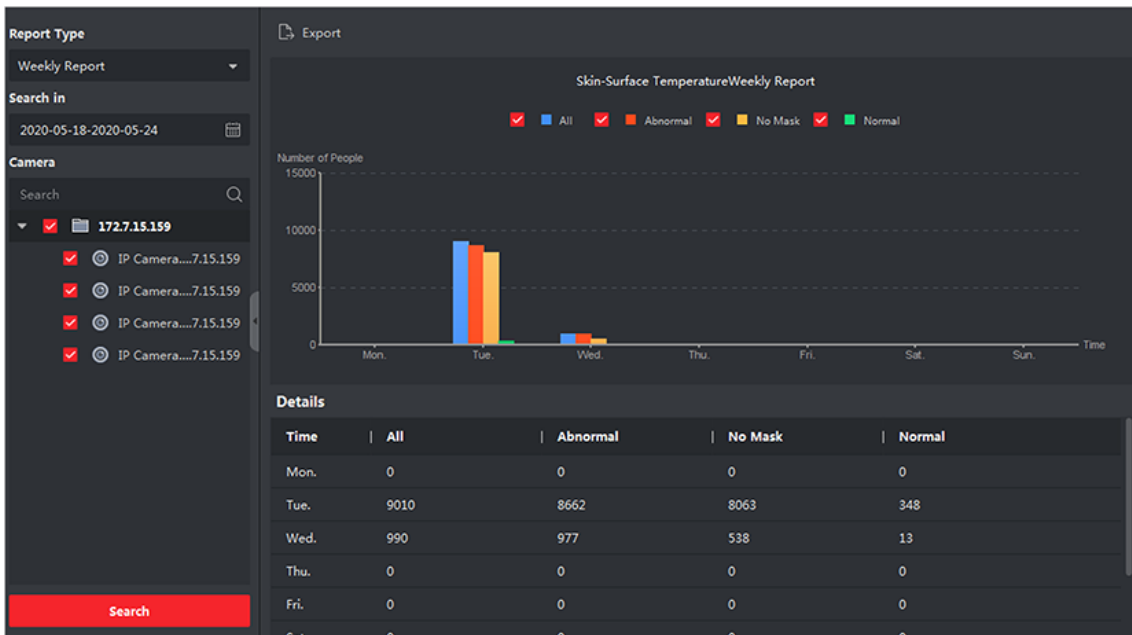

**Figure 10-10 Report of Skin-Surface Temperature Statistics**

6. **Optional:** Click **Export** to save the data in local by CSV format.

## 10.6 Real-Time Density and People Counting

Real-time density and people counting supports generating people density analysis report and real-time people counting report.

### Before You Start

Add a DeepinMind server to the software and properly configure a calculation rule. See [Add Device](#) for details about adding a DeepinMind server. See the device user manual about configuring calculation rule.

### Steps

1. Click **Report** → **Real-Time Density and People Counting** .

2. Select hourly report, daily report, monthly report, or annual report as the report type.

### **Hourly Report**

Hourly Report can be used for analyzing data generated during peak time.

### **Daily Report**

Daily report shows data on a daily basis. The system will calculate the number of people in each hour of one day.

### **Monthly Report and Annual Report**

Compared with daily report, monthly report and annual report can be less time consuming, since they are not submitted every day. The system will calculate the number of people in each day of one month and in each month of one year.

3. Click  to select time.
4. Select event type.

### **People Density Analysis**

The density of people in an area at different times.

### **Real-Time People Counting**

The numbers of people in an area at different times.

5. Select a calculation rule.
6. Click **Search**.



### **Note**

By default, the report will be shown in a line chart.

---

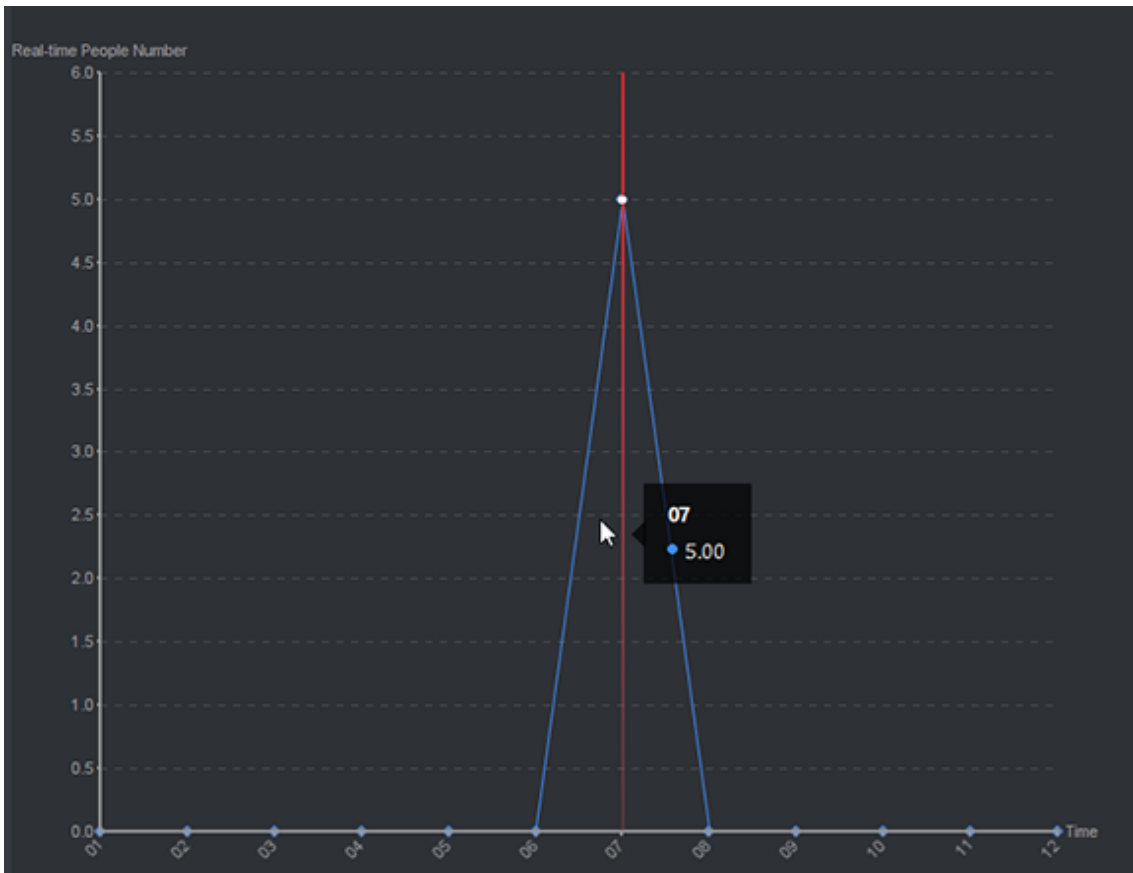

**Figure 10-11 People Density Analysis Report**

**7. Optional:** Click **Export** to save the report to your PC.

## 10.7 Temperature Map

A temperature map displays the temperature trend of a region during a certain day. If you have configured temperature monitoring regions, you can generate temperature map of specific regions to see the overview of each region's temperature trend.

### Before You Start

- Make sure you have drawn regions for temperature map on the device configuration page. See user manual of the device for details.
- Make sure you have added at least one device for temperature map to the client. See **Add Device** for details.

### Steps



**Note**

This function should be supported by device.

---



1. Click **Report** → **Temperature Map** .
2. Select a date from the calendar.
3. In the Camera list, select a camera.

## **Note**

You can enter a keyword in the searching field to search a camera.

4. Select a unit.
5. Select a preset.



**Figure 10-12 Temperature Map**

6. On the right panel, check region(s) for generating the report.

## **Note**

No more than 8 regions can be checked.

7. Click **Search**.

The temperature map will be displayed in a line chart with each line representing a region.

8. **Optional:** Select another unit to display the temperature map in another unit.

## Chapter 11 Data Retrieval

In the Data Retrieval module, you can search the face pictures captured by the face recognition camera, search the human body pictures captured by DeepinMind device, view behavior analysis related pictures and videos, search the vehicle pictures captured by DeepinMind device, search the frequently appeared person pictures captured by DeepinMind device, and search the not wearing hard hat pictures.

### 11.1 Face Picture Retrieval

When the connected device (e.g. NVR or HDVR) supports face search, you can search the related picture and play the picture related video file.

#### 11.1.1 Search Face by Uploaded Picture

You can upload a face picture from your PC and compare the uploaded picture with the captured face pictures.

##### Before You Start

Add the device to the software and properly configure the corresponding settings. Refer to **Add Device** for details about adding the device.

##### Steps

---

##### Note

This function should be supported by the connected device.

---

1. Click **Data Retrieval** → **Face Picture Retrieval** to enter the face picture retrieval page.
  2. Click  to set the start time and end time for searching the captured face pictures or video files.
  3. Select device(s) in the camera panel.
  4. Select **Picture** from the drop-down list.
  5. Select a face picture for search.
    - 1) Click **Select Picture** to upload the pictures from your PC.
    - 2) Select a detected face from uploaded picture for matching the captured face pictures.
- 

##### Note

- The resolution of the picture should be smaller than 4096×4080.
  - Only JPG and JPEG formats are supported.
- 

6. Set the similarity level.
-

## Example

If you set the similarity as 40, the captured pictures have no less than 40% similarity with the uploaded face picture will list.

7. Set the maximum number of displayed results.

8. Click **Search** to start searching.

The search results of the pictures are displayed on the right.

9. Export the pictures and save them in your PC.

## Export Picture

Select the pictures to be exported and save them in local PC.

## Export Current Page

Export all the pictures in the current page.

## Export Segment

You can download the pictures by packages. Each package contains up to 1,000 pictures.

10. Select a searched face picture to show the captured picture and person information.



Figure 11-1 Result

11. **Optional:** After searching, you can do one or more the following operations.

## View Details

View the captured face picture, and the person information (similarity, gender, temperature status, captured time, etc.) on the page.







You can also click  to show the large picture, and click  to restore.

## Play Related Videos

Click  to play the picture's related video file (5s before and 5s after the capture) in the view window on the bottom right.

---

## Note

- You can click  to show the large video, and click  to restore.
  - You can click  to adjust the play speed of the playback, click  to play back the video files frame by frame, click  to enable audio, double-click the playback window to maximize the window.
  - You can click  to view the captured picture.
- 

### **Export Single Record**

In the enlarged picture page, click  and then click **Export Picture**, **Export Video File** or **Export Details** to export the picture, video file, or capture details of single record to local PC.

### **Add Picture to Face Picture Library**

Click  to add the captured picture to the face picture library.

---

## Note

You can select the face picture library and enter the person information for the captured picture, such as person name, mobile phone, gender, etc.

---

## **12. Optional:** Perform secondary search based on the search result.

- 1) In the person information page, click .

All the faces in this picture will be analyzed and displayed.

- 2) In the pop-up window, move the red frame to select a face you want to do secondary search.
- 

## Note

If there are multiple faces in the picture, the window will pop up for selecting.

If there is only one face in the picture, skip this step.

---

- 3) Click **OK**.

The client will search and compare the faces in the captured pictures based on the face picture you selected.

## **11.1.2 Search Face by Event Type**

You can search the device's captured face pictures by filtering different event types.

### **Before You Start**

Add the device to the software and properly configure the corresponding settings. Refer to **Add Device** for details about adding the device.

### **Steps**

---

## Note

This function should be supported by the connected device.

---

1. Click **Data Retrieval** → **Face Search** to enter the face picture retrieval page.
  2. Click  to set the start time and end time for searching the captured face pictures or video files.
-

3. Select device(s) in the camera panel.
4. Select **Event Type** from drop-down list to search by event type.
5. Select event type.

### **No Limit**

Search all captured face pictures.

### **Matched Face**

Search the captured pictures the face in which matched with the face in face library.

### **Mismatched Face**

Search the captured pictures the face in which mismatched with the face in face library.

### **Stranger Detection Alarm**

Search the pictures captured when the stranger detection alarm is triggered.

6. Set the maximum number of displayed results.
7. Click **Search** to start searching.

The search results of the pictures are displayed on the right.

8. Export the pictures and save them in your PC.

### **Export Picture**

Select the pictures to be exported and save them in local PC.

### **Export Current Page**

Export all the pictures in the current page.

### **Export Segment**

You can download the pictures by packages. Each package contains up to 1,000 pictures.

9. Select a searched face picture to show the captured picture and person information.

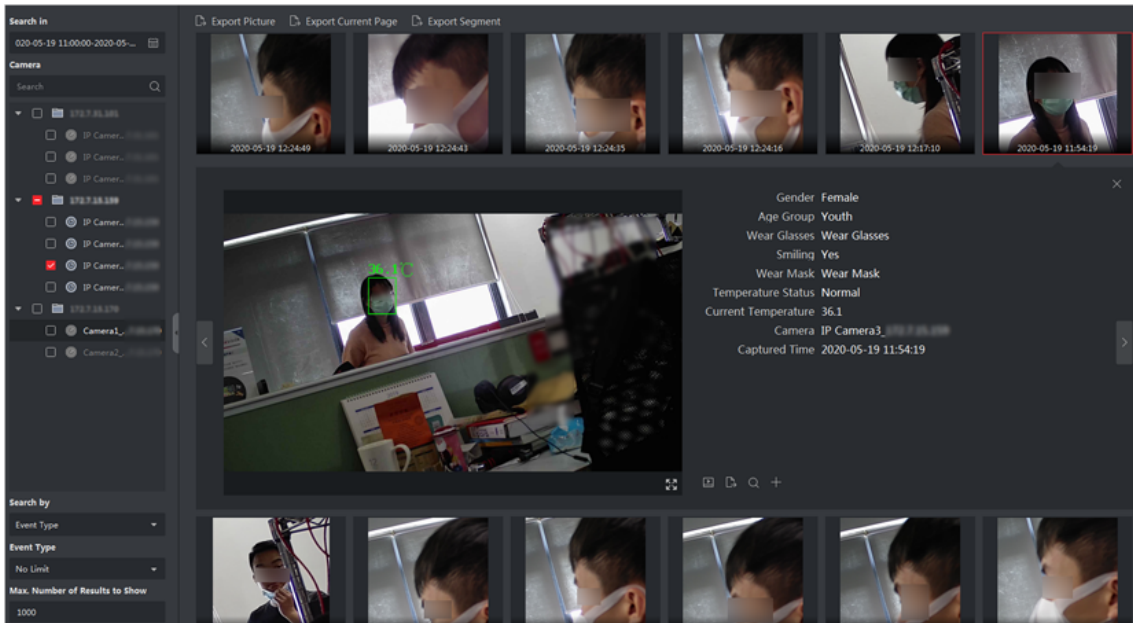

**Figure 11-2 Result**

**10. Optional:** After searching, you can do one or more the following operations.

**View Details**

View the captured face picture, and the person information (similarity, gender, temperature status, captured time, etc.) on the page.

You can also click to show the large picture, and click to restore.

**Play Related Videos**

Click to play the picture's related video file (5s before and 5s after the capture) in the view window on the bottom right.

**Note**

- You can click to show the large video, and click to restore.
- You can click to adjust the play speed of the playback, click to play back the video files frame by frame, click to enable audio, double-click the playback window to maximize the window.
- You can click to view the captured picture.

**Export Single Record**

In the enlarged picture page, click and then click **Export Picture**, **Export Video File** or **Export Details** to export the picture, video file, or capture details of single record to local PC.

**Add Picture to Face Picture Library**

Click to add the captured picture to the face picture library.

**Note**

You can select the face picture library and enter the person information for the captured picture, such as person name, mobile phone, gender, etc.

**11. Optional:** Perform secondary search based on the search result.

1) In the person information page, click .

All the faces in this picture will be analyzed and displayed.

2) In the pop-up window, move the red frame to select a face you want to do secondary search.

---

### **Note**

If there are multiple faces in the picture, the window will pop up for selecting.

If there is only one face in the picture, skip this step.

---

3) Click **OK**.

The client will search and compare the faces in the captured pictures based on the face picture you selected.

### 11.1.3 Search Face by Person Name

You can search the device's captured face pictures by person name.

#### **Before You Start**

Add the device to the software and properly configure the corresponding settings. Refer to **Add Device** for details about adding the device.

#### **Steps**

---

### **Note**

This function should be supported by the connected device.

---

1. Click **Data Retrieval** → **Face Search** to enter the face picture retrieval page.
2. Select device(s) in the camera panel.
3. Select **Name** from the drop-down list to search by person name.
4. Click  to set the start time and end time for searching the captured face pictures or video files.
5. Enter a keyword for the person name.
6. Set the maximum number of displayed results.
7. Click **Search** to start searching.

All the persons whose name match the search condition (fuzzy match is supported) will be displayed.

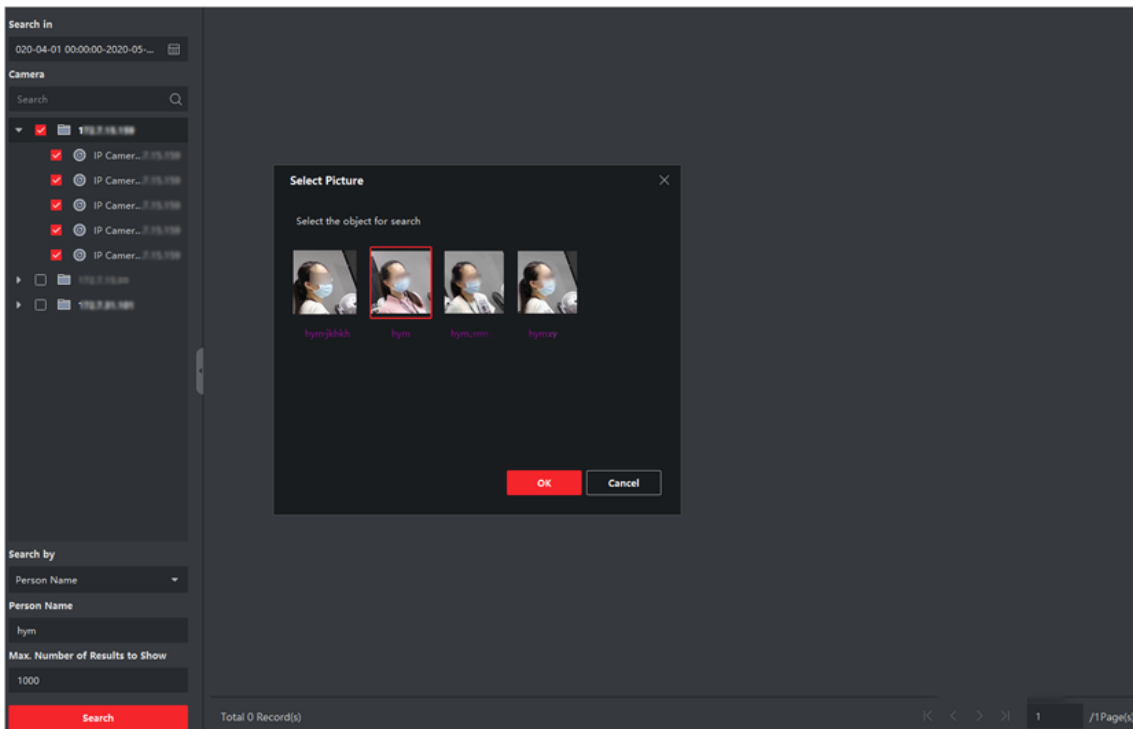

**Figure 11-3 Results**

8. Select one picture to search, and then click **Confirm**.

The search results of the pictures are displayed on the right.

9. Export the pictures and save them in your PC.

### **Export Picture**

Select the pictures to be exported and save them in local PC.

### **Export Current Page**

Export all the pictures in the current page.

### **Export Segment**

You can download the pictures by packages. Each package contains up to 1,000 pictures.

10. Select a searched face picture to show the captured picture and person information.



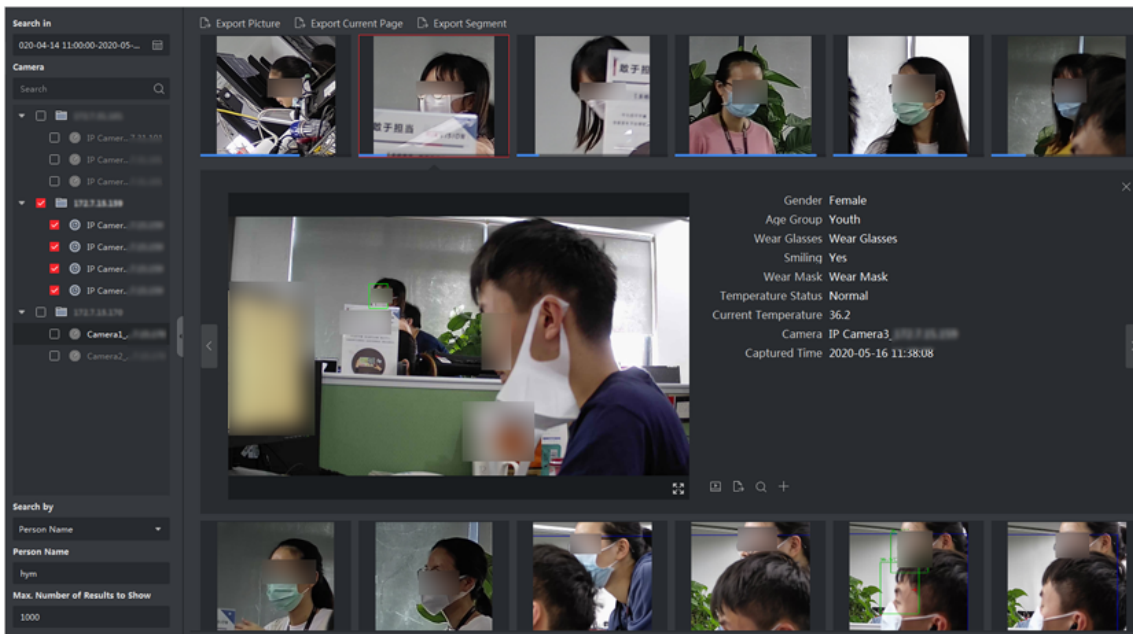

**Figure 11-4 Results**

**11. Optional:** After searching, you can do one or more the following operations.

**View Details**

View the captured face picture, and the person information (similarity, gender, temperature status, captured time, etc.) on the page. You can also click to show the large picture, and click to restore.

**Play Related Videos**

Click to play the picture's related video file (5s before and 5s after the capture) in the view window on the bottom right.

**Note**

- You can click to show the large video, and click to restore.
- You can click to adjust the play speed of the playback, click to play back the video files frame by frame, click to enable audio, double-click the playback window to maximize the window.
- You can click to view the captured picture.

**Export Single Record**

In the enlarged picture page, click and then click **Export Picture**, **Export Video File** or **Export Details** to export the picture, video file, or capture details of single record to local PC.

**Add Picture to Face Picture Library**

Click to add the captured picture to the face picture library.

**Note**

You can select the face picture library and enter the person information for the captured picture, such as person name, mobile phone, gender, etc.

**12. Optional:** Perform secondary search based on the search result.

1) In the person information page, click .

All the faces in this picture will be analyzed and displayed.

2) In the pop-up window, move the red frame to select a face you want to do secondary search.

---

 **Note**

If there are multiple faces in the picture, the window will pop up for selecting.

If there is only one face in the picture, skip this step.

---

3) Click **OK**.

The client will search and compare the faces in the captured pictures based on the face picture you selected.

### 11.1.4 Search Face by Facial Features

The client supports searching detected face pictures by facial features such as gender, glasses wearing, etc.

#### Steps

1. Click **Data Retrieval** → **Face Picture Retrieval** .

2. Select a time period for searching.

3. Select a camera in the camera list.

4. Select **Facial Features** as the searching type.

5. Configure facial features to be searched, including age group, gender, wear glasses, smiling and wear mask.

6. Enter the maximum number of results to show.

7. Click **Search**.

The searched face pictures are displayed on the right.

8. Export the pictures and save them in your PC.

#### Export Picture

Select the pictures to be exported and save them in local PC.

#### Export Current Page

Export all the pictures in the current page.

#### Export Segment

You can download the pictures by packages. Each package contains up to 1,000 pictures.

**9. Optional:** Select a searched face picture to show the captured picture and person information.

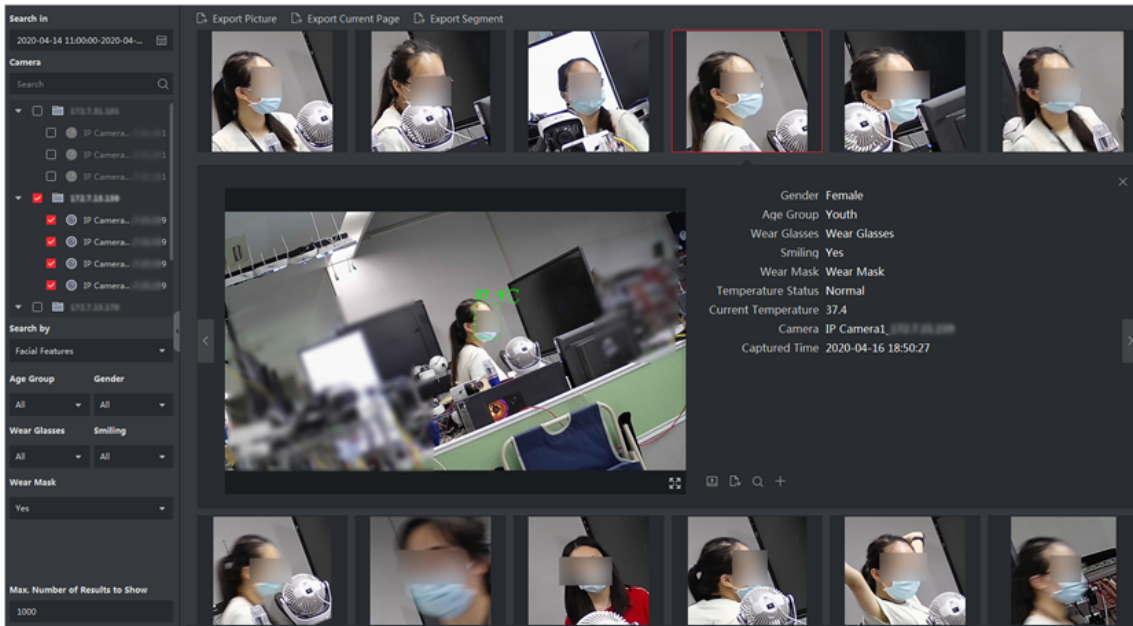

**Figure 11-5 Result**

**10. Optional:** After searching, you can do one or more the following operations.

**View Details**

View the captured face picture, and the person information (similarity, gender, temperature status, captured time, etc.) on the page.

You can also click to show the large picture, and click to restore.

**Play Related Videos**

Click to play the picture's related video file (5s before and 5s after the capture) in the view window on the bottom right.

**Note**

- You can click to show the large video, and click to restore.
- You can click to adjust the play speed of the playback, click to play back the video files frame by frame, click to enable audio, double-click the playback window to maximize the window.
- You can click to view the captured picture.

**Export Single Record**

In the enlarged picture page, click and then click **Export Picture**, **Export Video File** or **Export Details** to export the picture, video file, or capture details of single record to local PC.

**Add Picture to Face Picture Library**

Click to add the captured picture to the face picture library.

**Note**

You can select the face picture library and enter the person information for the captured picture, such as person name, mobile phone, gender, etc.

**11. Optional:** Perform secondary search based on the search result.

1) In the person information page, click .

All the faces in this picture will be analyzed and displayed.

2) In the pop-up window, move the red frame to select a face you want to do secondary search.

---

### **Note**

If there are multiple faces in the picture, the window will pop up for selecting.

If there is only one face in the picture, skip this step.

---

3) Click **OK**.

The client will search and compare the faces in the captured pictures based on the face picture you selected.

## 11.2 Human Body Retrieval

For the DeepinMind device, you can search the captured human body pictures by setting search conditions including uploading a picture from local PC and setting features, and view related videos of the picture.

### 11.2.1 Search Human Body by Uploaded Picture

For the DeepinMind device, you can upload a human body picture from local PC and compare the uploaded picture with the device's captured human body pictures, or search all the human body pictures captured by the specific camera(s) during a specific time.

#### **Before You Start**

Add the device to the software and properly configure the corresponding settings. Refer to **Add Device** for details about adding the device.

#### **Steps**

---

### **Note**

This function should be supported by the connected device.

---

1. Click **Data Retrieval** → **Human Body Retrieval** to enter the human body retrieval page.
2. Click  to set the start time and end time for searching the captured human body pictures or video files.
3. Select device(s) in the camera panel.
4. Select the search condition in the Search by field.

#### **Picture**

Upload a picture to compare the uploaded picture with the device's captured human body pictures. All the human bodies in this picture will be analyzed and displayed.

- a. Click **Select Picture** to select a picture for comparison from the computer.

## Note

- The picture should be smaller than 4 MB.
- The resolution of the picture should be smaller than 4096\*4080.
- Only JPG and JPEG formats are supported.

- b. Set the similarity level. For example, if you set the similarity as 40, the captured pictures have no less than 40% similarity with the uploaded human body picture will list.

## All

Search all the pictures captured by the selected camera(s) during the time duration.

5. Set the maximum number of displayed results.

## Note

If the number of pictures captured by the selected cameras(s) during the selected time duration exceeds the number of maximum number to be displayed, only the lasted pictures will be displayed.

For example, if the number of pictures captured by the selected cameras during the selected time duration is 2000, and the maximum number to be displayed is 1000, only the lasted 1000 pictures will be displayed.

6. Click **Search** to start searching.

The search results of the pictures are displayed in list.

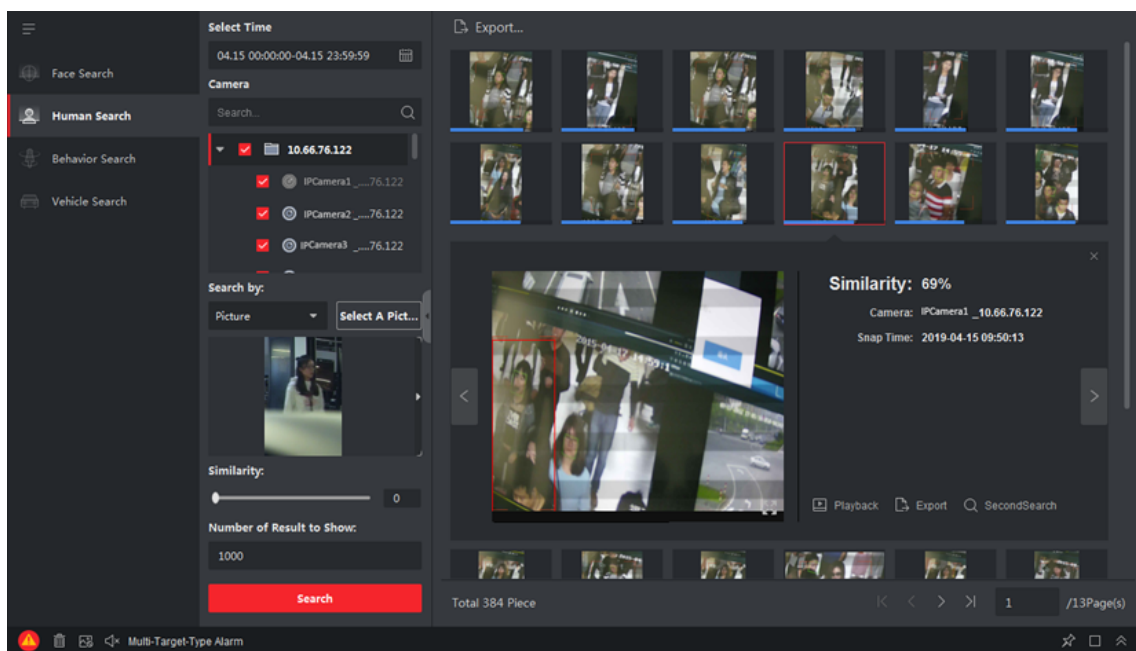

**Figure 11-6 Search Result**

7. **Optional:** Perform secondary search based on the search result



- 1) Move to the searched picture and click 

All the human bodies in this picture will be analyzed and displayed.

- 2) Select a human body you want to do secondary search.
- 3) Set the similarity and time period.
- 4) Click **Search**.

The client will search and compare the human bodies in the captured pictures based on the human body picture you selected.





**8. Optional:** After searching human body, you can do one or more the following operations.

**View Details** Click on a picture from the list to view details. You can also click  to show the large picture, and click  to restore.

**Play Related Videos** Click **Playback** to play the picture's related video file (5s before and 5s after the capture) in the view window on the bottom right.

---

 **Note**

- You can click  to show the large video, and click  to restore.
  - You can click  to adjust the play speed of the playback, click  to play back the video files frame by frame, click  to enable audio, double-click the playback window to maximize the window.
- 

**Export Single Record** In the enlarged picture page, click  and then click **Export Picture**, **Export Video File** or **Export Details** to export the picture, video file, and capture details of single record to local PC.

## 11.2.2 Search Human Body by Personnel Features

You can search the device's captured human body pictures by setting the personnel features as the search conditions, such as age group, gender, clothes, etc.

### Before You Start

Add the device to the software and properly configure the corresponding settings. Refer to **Add Device** for details about adding the device.

### Steps

---

 **Note**

This function should be supported by the connected device.

---

1. Click **Data Retrieval** → **Human Body Retrieval** to enter the human body retrieval page.
2. Click  to set the start time and end time for searching the captured human body pictures or video files.
3. Select device(s) in the camera panel.
4. Select **Features** as the search mode.
5. Set the person features such as age group, gender, top's color, wearing glasses or not, etc.
6. Select the event type of the human body pictures you want to search.
7. Set the maximum number of displayed results.

8. Click **Search** to start searching.

The search results of the pictures are displayed in list.

9. **Optional:** Perform secondary search based on the search result

1) Move to the searched picture and click .

All the human bodies in this picture will be analyzed and displayed.



2) Select a human body you want to do secondary search.

3) Set the similarity and time period.

4) Click **Search**.





The client will search and compare the human bodies in the captured pictures based on the human body picture you selected.

10. **Optional:** After searching, you can do one or more the following operations.

**View Details** Click on a picture from the list to view details. You can also click  to show the large picture, and click  to restore.

**Play Related Videos** Click  to play the picture's related video file in the view window on the bottom right.



- You can click  to show the large video, and click  to restore.
  - You can click  to adjust the play speed of the playback, click  to play back the video files frame by frame, click  to enable the audio, double-click the playback window to maximize the window.
- 

**Export Single Record** In the enlarged picture page, click  and then click **Export Picture**, **Export Video File** or **Export Details** to export the picture, video file, or capture details of single record to local PC.

### 11.3 View Behavior Analysis Related Pictures and Videos

After adding the device that supports behavior analysis, you can search the related events such as line crossing, people gathering and loitering in the client. You can view the event details including the captured pictures and related videos.

#### Before You Start

Add the device that supports behavior analysis to the client and properly configure the corresponding settings. See [Add Device](#) for details about adding the device.

#### Steps

1. Click **Data Retrieval** → **Behavior Analysis** to enter the behavior analysis page.
2. Click  to set the start time and end time for search.
3. Select the search type as camera, task or rule from the drop-down list.

**Camera**



Search and display behavior analysis related information detected by the camera.

### Task

Search and display the results according to the tasks you have added for the behavior analysis server.

### Rule

Search and display the results according to the rules you have configured for a task of the behavior analysis server.

---

### Note

Searching by task and rule should be supported by the device. You should have added tasks to the behavior analysis server and configure related rules for the tasks. For each task, you can configure multiple rules such as line crossing and region entrance.

---

#### 4. Select a search method.

- When selecting **Camera** as the search type, select a camera from the camera list.
  - When selecting **Task** as the search type, select a task or a behavior analysis server from the task list.
  - When selecting **Rule** as the search type, select a rule from the rule list.
- 

### Note

You can enter a key word in the search box (supports fuzzy search) to quickly find the target camera, task, or rule.

---

#### 5. **Optional:** Check **False Alarm Deduction** to remove the false alarms from the results.

### Example

The camera might sometimes take tree-shaking as a motion detection alarm or take an animal as a person triggering line crossing alarm probably for high sensitivity, which will be taken as false alarms by an NVR or DVR.

#### 6. **Optional:** Select one or more event types from the drop-down list for search.

---

### Note

You can skip this step if you select **Rule** in step 3.

---

#### 7. Click **Search** to start searching.

The captured pictures which meet the search conditions are displayed on the right panel. Up to 30 pictures can be displayed on one page.

#### 8. **Optional:** For the searched pictures, you can perform the following operations.

### **Export Picture**

You can export one or more searched pictures.

- Click **Export Picture**.
  - Check one or more picture(s), or check **Select All** on the page below.
  - Click **Export** to export the selected picture(s) to local PC.
-



**View Capture Details** Click a picture to view its capture details such as captured time and camera name.

---







You can click  to view an enlarged picture.

---

**Play Related Video** Click **Playback** to play the picture's related video file (5s before and 5s after the capture) in the view window.

---



- You can click  to view the video in a larger window.
  - You can click  to adjust the play speed of the playback, click  to play back the video file frame by frame, and click  to enable audio.
- 

## 11.4 Vehicle Retrieval

For devices that support vehicle retrieval, you can search the related vehicle pictures and videos by setting the search conditions such as plate number and captured time.

### Before You Start

Add the device that supports vehicle retrieval to the client and properly configure the corresponding settings. See [Add Device](#) for details about adding the device.

### Steps

1. Click **Data Retrieval** → **Vehicle Retrieval** to enter the vehicle retrieval page.
2. Click  to set the start time and end time for search.
3. Select the search type.

#### Vehicle

Search and display the captured vehicle pictures by entering the vehicles' license plate number.

#### Mix-traffic Detection

Search and display the mix-traffic detection related pictures of the specific vehicle by entering the vehicle's license plate number.

---



The camera should support mix-traffic detection.

---

#### Traffic Violations

Search and display the traffic violation related pictures of the specific vehicle by entering the vehicle's license plate number.

---

 **Note**

The camera should support traffic violation.

- 
4. Select a device from the camera list.

---

 **Note**

You can enter a key word (supports fuzzy search) in the search box to quickly search the target device.

- 
5. **Optional:** Check **Vehicle Features** and select the related vehicle features such as brand and color from drop-down list to search vehicles with specific features.

---

 **Note**

This function should be supported by the device. For different devices, you can search different vehicle features.

- 
6. **Optional:** Enter the license plate number (support fuzzy search) for search.

7. **Optional:** Set the maximum number of searched results to be displayed.

8. Click **Search** to start searching.

The captured pictures which meet the search conditions are displayed on the right panel. Up to 30 pictures can be displayed on one page.

9. **Optional:** Perform the following operations if needed.

**Export  
Picture**

You can export one or more searched pictures.

- a. Click **Export Picture**.
- b. Check one or more picture(s), or check **Select All** on the page below.
- c. Click **Export** to export the selected picture(s) to local PC.

**View  
Capture  
Details**

Click a picture to view its capture details such as captured time and camera name.

---

 **Note**

You can click  to view an enlarged picture.





---

**Play  
Related  
Video**

Click **Playback** to play the picture's related video file (5s before and 5s after the capture) in the view window.

---

 **Note**

- You can click  to view the video in a larger window.
- You can click  to adjust the play speed of the playback, click  to play back the video file frame by frame, and click  to enable audio.

---

**Export  
Single  
Record**

In the enlarged picture page, click  and then click **Export Picture**, **Export Video File** or **Export Details** to export the picture, video file, and capture details of single record to local PC.

## 11.5 Hard Hat Retrieval

After adding the hard hat detection device to the client, when the device detects a person who doesn't wear a hard hat, it will trigger an event and capture some pictures to notify the managers. You can search the alarm pictures in which the detected person doesn't wear a hard hat. By this way, you can remind the builders to wear hard hats, and thus to improve builders' safety awareness.

### Before You Start

Add the device(s) with hard hat detection function to the client. See [Add Device](#) for details about adding the device.

### Steps

1. Click **Data Retrieval** → **Hard Hat Search** to enter the hard hat search page.
2. Click  to set the start time and end time for search.
3. Select the camera for search.

---

#### Note

You can enter a key word (support fuzzy search) in the search box to quickly search the target camera(s).

- 
4. **Optional:** Select the hard hat detection status.
  5. **Optional:** Select the face picture comparison result.

---

#### Note

When selecting the results of succeeded face picture comparison, you can search by the person name or the face picture library.

- 
6. **Optional:** Set the maximum number of searched results to be displayed.
  7. Click **Search**.

The captured pictures which meet the search conditions are displayed on the right panel. Up to 30 pictures can be displayed on one page.

8. **Optional:** Perform the following operations if needed.

- |                       |   |
|-----------------------|---|
| <b>Export Picture</b> | You can export one or more searched pictures. <ol style="list-style-type: none"><li>a. Click <b>Export Picture</b>.</li><li>b. Select one or more picture(s), or check <b>Select All</b> on the page below.</li><li>c. Click <b>Export</b> on the page below to export the selected picture(s).</li></ol> |
|-----------------------|---|

- |                             |  |
|-----------------------------|--|
| <b>View Capture Details</b> | Click a picture to view its capture details such as captured time and camera name. |
|-----------------------------|--|

---

#### Note

You can click  to view an enlarged picture.





---

## Play Related Video

Click **Playback** to play the picture's related video file (5s before and 5s after the capture) in the view window on the bottom right.

---



- You can click  to view the video in a larger window.
  - You can click  to adjust the play speed of the playback, click  to play back the video file frame by frame, and click  to enable audio.
- 

## 11.6 People Frequency Search

People frequency refers to the appearance frequency of a person happened in the detection area during a certain period of time. Frequently appeared person refers to a person whose appearance frequency exceeds the predefined threshold, while rarely appeared person refers to a person whose appearance frequency is lower than the predefined threshold. The client supports searching frequently appeared people to protect places requiring high security and rarely appeared people who may be in trouble if they rarely appear during a certain time period.

### 11.6.1 Search Frequently Appeared Person

The person's captured face picture can be compared with the face pictures in the face picture library. If mismatched, he/she will be judged as frequently appeared person, and trigger an event to notify the security person. For example, in some high-safety demanded scene (e.g. bank), if a stranger appears frequently, the event can be triggered to notify the security personnel or related person. If matched, he/she will be judged as a person in allowlist and will not trigger frequently appeared person alarm. You can search the event information in a certain time, such as the captured pictures, captured time, and you can view the detailed pictures and play back the related video.

#### Before You Start

Make sure the frequently appeared person alarm has been configured on the device.

#### Steps

1. Click **Data Retrieval** → **People Frequency Search** → **Frequently Appeared Person** .
2. Set the start time and end time for searching.
3. Select the device(s) for searching.
4. Click **Search**.

The frequently appeared person alarm related pictures will be displayed on the right panel.

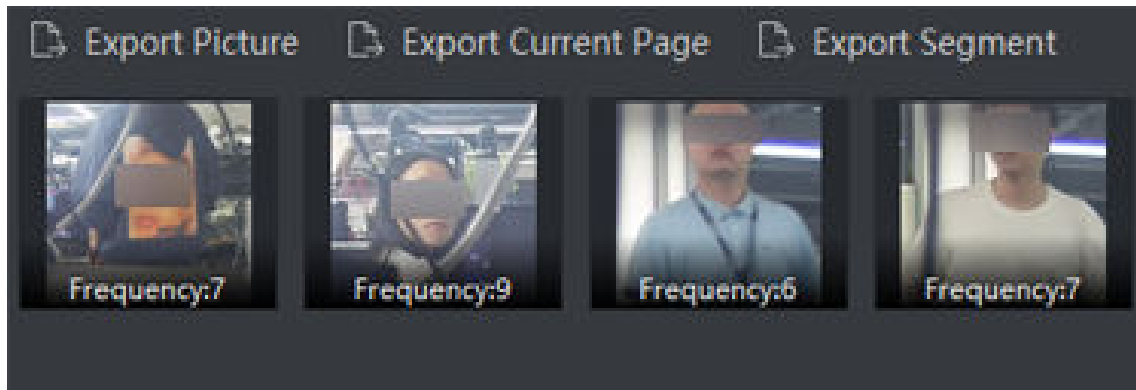

**Figure 11-8 Results**

5. **Optional:** Click the picture to view the whole captured picture, the captured time, etc.
6. **Optional:** Export the picture(s) to the local PC.
  - Click **Export Picture**, and then select the picture to be exported, and then click **Export**.
  - Click **Export Current Page** to export all the pictures and information on the current page.
  - Click **Export Segment** to download the pictures and capturing information by packages. Each package contains up to 1,000 pictures.
7. **Optional:** Perform the following operations if needed.

<b>Add to Face Picture Library</b>	Click <b>Add to face picture library</b> to add current face picture to the library .
<b>View Detailed Information</b>	Click <b>View</b> to view the historical captured pictures of this person, the captured time.
<b>Playback</b>	Click <b>Playback</b> to play back the video of 5-seconds before and after the capturing time.
<b>Export</b>	Click the picture to be exported, and then click <b>Export</b> to export this picture.

### 11.6.2 Search Rarely Appeared Person

The device will send rarely appeared person report to the client regularly giving information including who did not appear for enough times so that security persons will know on time and go to check the person. This function is often used for seniors living alone and prisoners. If they have not appear for a period of time, security persons need to find them and confirm they are not in trouble or escaped.

#### Before You Start

- Make sure the frequently appeared person alarm has been configured on the device.
- Make sure you have configured detecting time, statistic period, frequency threshold, and face picture library on the device remote configuration page.

**Steps**

1. Click **Data Retrieval** → **People Frequency Search** → **Rarely Appeared Person** .
2. Set the start time and end time for searching.
3. Select the device(s) for searching.
4. Click **Search**.

The rarely appeared person reports will be displayed on the right panel.

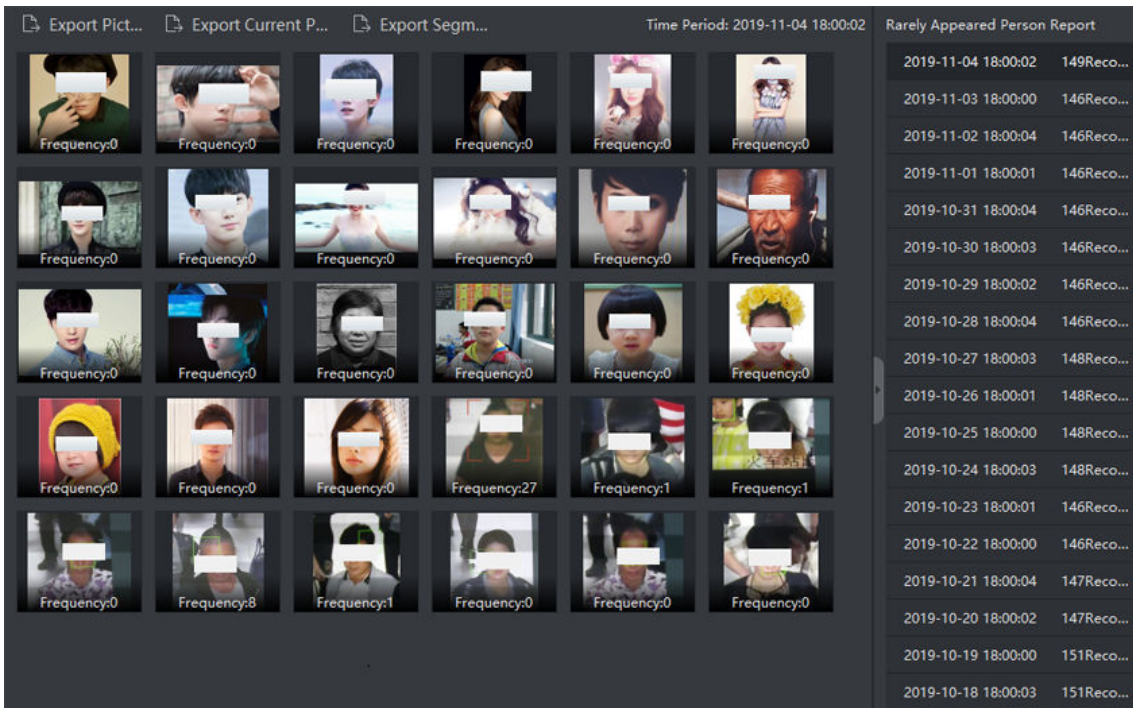

**Figure 11-9 Result**

5. Double-click a report to show the rarely appeared persons.
6. **Optional:** Click the picture to view the captured picture's details.
7. **Optional:** Export the picture(s) to the local PC.
  - Click **Export Picture**, and then select the picture to be exported, and then click **Export**.
  - Click **Export Current Page** to export all the pictures and information on the current page.
  - Click **Export Segment** to download the pictures and capturing information by packages. Each package contains up to 1,000 pictures.

**11.7 AI Dashboard Retrieval**

You can search result for video and captured picture task and imported picture task, to view the detailed information of the task.

## Note

The video analysis task is only configured on web client, while picture analysis task can be configured on web client or control client.

### 11.7.1 Search Analysis Result for Video and Captured Picture Task

You can search result for video and captured picture analysis task, to view the related video and pictures.

#### Before You Start

Add the device that support AI Dashboard Platform to the platform.

#### Steps

1. Enter **Data Retrieval** module.
2. Select **AI Dashboard Retrieval**.
3. Click  to set the time range for task searching.
4. Select **Video & Capture Analysis Task** as task type.
5. Select **Task** or **Camera** as the major type.
6. Select a task or camera.
7. Select one or multiple algorithms or device engines.
8. Click **Search**, and the task list will be displayed on the right area.

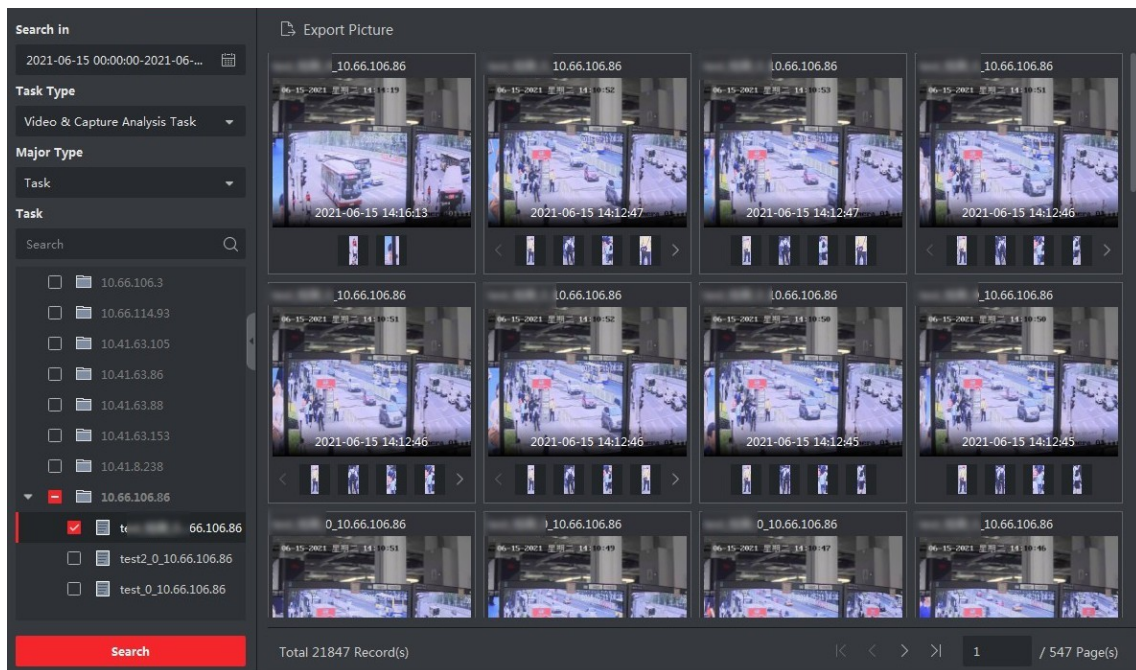

Figure 11-10 Search Analysis Result for Video and Captured Picture Task



## Note

If the device has been configured combined rule alarm, the combined rule will displayed on the result.

---

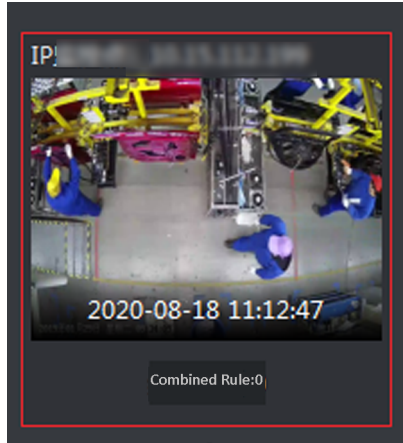

**Figure 11-11 Combine Rule Alarm**



**9. Optional:** Perform the following operations according to actual requirement.

- |                       |   |
|-----------------------|---|
| <b>Export Picture</b> | Select the picture or information record on the right area and then click <b>Export Picture</b> to save the picture to the designed path. |
| <b>View Details</b>   | Select one picture or information record and then click it to view the alarm information or video footage.                                |
- 

## Note

The video is recorded 5 seconds before or after the capture time. Supports playing, pausing, single frame playing and volume adjusting.

---

- |                     |  |
|---------------------|--|
| <b>Display Mode</b> | Click  or  to display the task by thumbnails or by list. |
|---------------------|--|

## 11.7.2 Search Analysis Result for Imported Picture Task

You can search result for imported picture analysis task, to view the related picture files and picture information.

### Before You Start

Add the device that support AI Dashboard Platform to the platform.

### Steps



1. Enter **Data Retrieval** module.
2. Select **AI Dashboard Retrieval**.



3. Click  to set the time range for task searching.
4. Select **Picture Importing Analysis Task** as task type.
5. Select **Task** or **Camera** as the major type.
6. Select a task or camera.
7. Select one or multiple algorithms or device engines.
8. Click **Search**.

The task list is displayed on the right area.

9. **Optional:** Perform the following operations according to actual requirement.

- Export Picture**      Select the picture or information record on the right area and then click **Export Picture** to save the picture to the designed path.
- View Picture Details**      Select one picture or information record, click it to amplify the picture or tag information (such as vehicle).
- Display Mode**      Click  or  to display the task by thumbnails or by list.

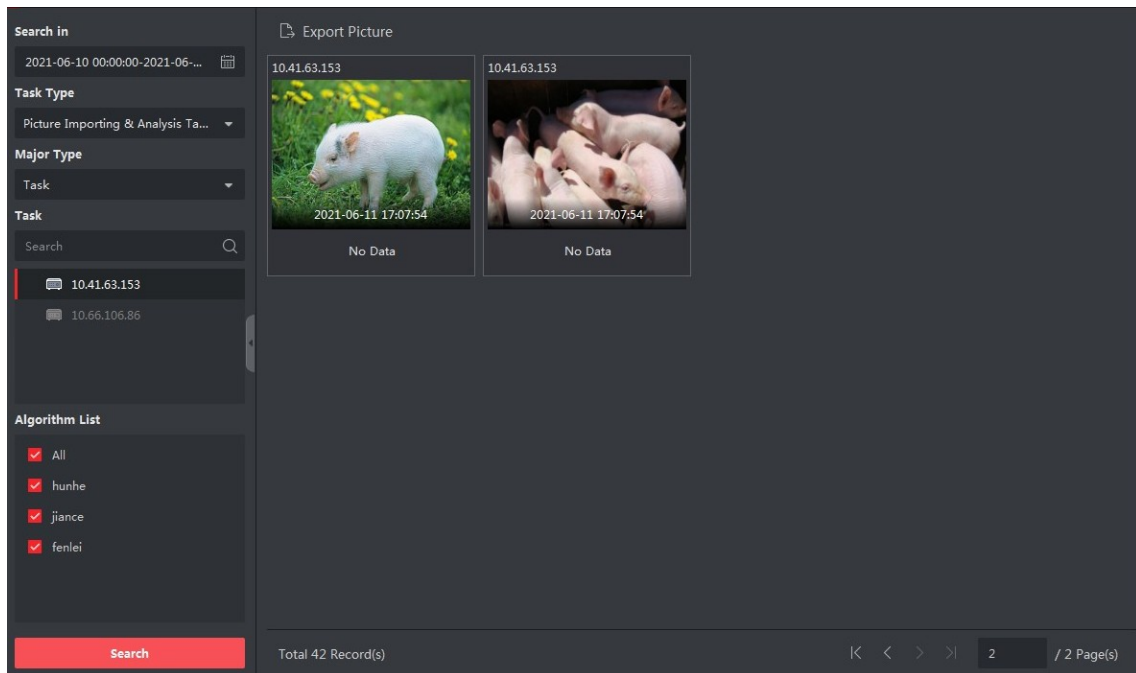

Figure 11-12 Search Analysis Result for Imported Picture Task

## 11.8 Facial Recognition Check-in

For the device that supports facial recognition, the person can check in on the device by facial recognition. By comparing the recognized face with the face picture library, if matched, the system will record it as a successful face comparison record. If the successful face comparison record is

during the check-in period, it will be regarded as a check-in record. Further more, the attendance records can also be calculated based on the successful face comparison records.

According to your requirement, you can search facial recognition check-in records or facial recognition attendance records.

### 11.8.1 Search Facial Recognition Check-in Records

You can search for the check-in records of the persons who checked in by facial recognition during the specified period and export the data to the local PC.

#### Before You Start

Add the device to the software and properly configure the corresponding settings. See [Add Device](#) for details about adding the device.

#### Steps

---



This function should be supported by the connected device.

---

1. Enter **Data Retrieval** → **Face Recognition Check-in** → **Check-In Search** .
2. Click  to set the start time and end time for searching.

#### Example

If you need to search the check-in records in march, you can set the time as 2020-03-01--2020-03-31.

3. Set the **Check-In Period**.
4. Check cameras used for face recognition check-in.
5. Check one or multiple face picture libraries to search the persons attendance in the selected library.
6. Enter the maximum number of the results to show.
7. Click **Search** to start searching.

The searched results show the attendance records including the face picture, face library, name, and check-in counts.

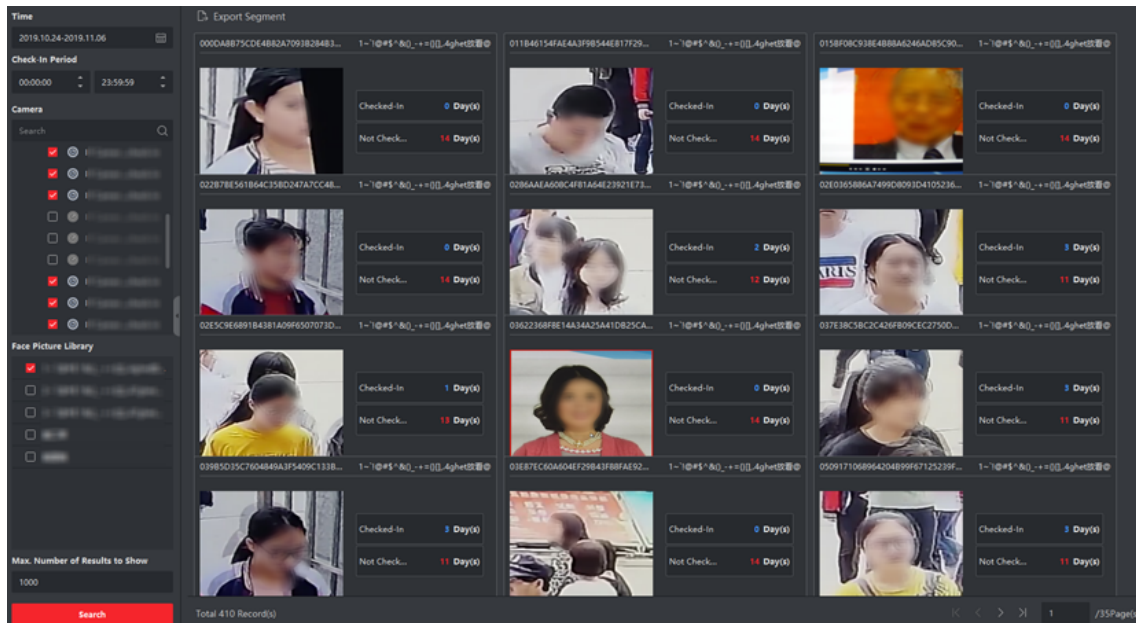

Figure 11-13 Result

8. **Optional:** Click **Export All** in the upper right corner to export the data to local PC.

### 11.8.2 Search Facial Recognition Attendance Records

You can search the attendance records of the persons who checked in by facial recognition. You can search the daily, monthly, yearly attendance records of the persons who checked in successfully on the face picture library to help you know the attendance status (normal, late, leave early or absent) of the staffs. Attendance status is the result calculated by comparing the check-in period on the search condition with the successful face comparison records (earliest and latest). You can export the attendance records to view the attendance data of the staffs.

#### Before You Start

Add the device to the software and properly configure the corresponding settings. See [Add Device](#) for details about adding the device.

#### Steps

1. Select **Data Retrieval** → **Facial Recognition Check-in** → **Attendance Search** .
2. Set time range of records for searching.

#### Example

If you need to search the attendance records of march, you can set the time as 2020-03-01 - 2020-03-31.

3. Set the **Check-In Period**.

## Example

If the **Check-in Period** is set as 08:00 - 17:00, the check-in earlier than 08:00 and check-out later than 17:00 will be regarded as normal attendance.

4. Select **Attendance Period** according to the work day.

## Example

If the weekend is for rest, you can select Monday, Tuesday, Wednesday, Thursday and Friday as **Attendance Period**.

5. Select the camera for facial recognition check-in.



## Note

You can only select the camera(s) in the same NVR.

6. Select the **Face Picture Library**.

After selecting the face picture library, only the attendance records of the persons in the library will be searched. You configure the face picture library on the remote configure page of device, or log into the device to configure.

7. Set the Max. Number of Results to show.
8. Click **Search**.

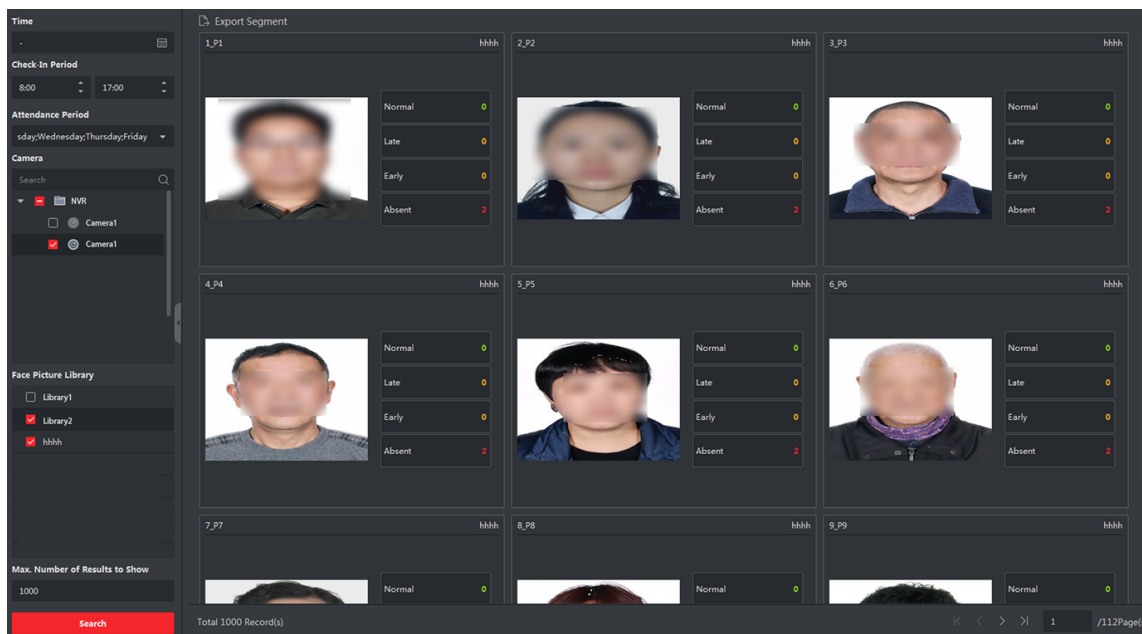

Figure 11-14 Face Recognition Attendance Search

## Normal

The earliest check-in record (the earliest facial recognition comparison successful record) should not be later than the check-in start time, while the latest check-out record (the latest facial recognition comparison successful record) should not be earlier than the check-in end time.

For example, if the **Check-in Period** is set as 08:00 - 17:00, the check-in earlier than 08:00 and check-out later than 17:00 will be regarded as normal attendance.

### Late

The check-in record (the earliest facial recognition comparison successful record) is later than the check-in start time.

If you set the **Check-in Period** as 08:00- 17:00, the check-in between 08:00-17:00 and check-out later than 17:00 will be regarded as late.

### Leave Early

The check-out record (the latest facial recognition comparison successful record) is earlier than the check-in end time.

If you set the **Check-in Period** as 08:00- 17:00, the check-in earlier than 08:00 and check-out between 08:00- 17:00 will be regarded as late.

### Absent

If no facial recognition comparison successful record is found during the check-in period, the attendance record will be regarded as absent.

The searched results show the attendance records including face picture, face library, name and check-in counts.

**9. Optional:** Click **Export by Segment**, to export the attendance records to the local PC.

## 11.9 Community Inspection

For the added device that supports community inspection, you can search the captured pictures and the related video file for community related events, including fire engine access detection, elevator detection, and urban management event.

### 11.9.1 Detect Fire Engine Access

When the added device detects a place (such as the stairway and passage) where the fire engine access is occupied, an event will be triggered, and the device will capture pictures and videos. You can search and view the device's captured pictures and related videos via the client. This can help to remove the objects that occupy the fire engine access and perform rescue operations when a fire happens.

#### Before You Start

You should have added the device to the client and properly configure the corresponding settings. See **Add Device** for details about adding the device.

#### Steps

1. Click **Data Retrieval** → **Fire Engine Access Detection** to enter the fire engine access detection page.
2. Click  to set the start time and end time for search.

3. Select a camera in the camera list.

---

## Note

You can enter a key word (supports fuzzy search) in the search box to quickly find the target camera(s).

4. **Optional:** Set the maximum number of searched results to be displayed.

5. Click **Search** to start searching.

The captured pictures which meet the search conditions are displayed on the right panel. Up to 30 pictures can be displayed on one page.

6. **Optional:** For the searched pictures, you can perform the following operations.

<b>Export Picture</b>	You can export one or more searched pictures. <ol style="list-style-type: none"><li>a. Click <b>Export Picture</b>.</li><li>b. Check one or more picture(s), or check <b>Select All</b> on the page below.</li><li>c. Click <b>Export</b> to export the selected picture(s) to local PC.</li></ol>
<b>View Capture Details</b>	Click a picture to view its capture details such as captured time and camera name.

---

## Note





You can click  to view an enlarged picture.

---

<b>Play Related Video</b>	Click <b>Playback</b> to play the picture's related video file (5s before and 5s after the capture) in the view window.
---------------------------	---

---

## Note

- You can click  to view the video in a larger window.
- You can click  to adjust the play speed of the playback, click  to play back the video file frame by frame, and click  to enable audio.

## 11.9.2 Detect Elevator

When the added device detects an electric moped entering the elevator, an event will be triggered, and the device will capture pictures and videos. You can view the device's captured pictures and the related video in the client. This can help to ease the loading burden of elevators.

### Before You Start

You should have added the device to the client and properly configure the corresponding settings. See [Add Device](#) for details about adding the device.

### Steps

1. Click **Data Retrieval** → **Elevator Detection** to enter the elevator detection page.
2. Click  to set the start time and end time for search.
3. Select a camera in the camera list.

---

## Note

You can enter a key word (supports fuzzy search) in the search box to quickly find the target camera(s).

---

4. **Optional:** Set the maximum number of searched results to be displayed.

5. Click **Search** to start searching.

The captured pictures which meet the search conditions are displayed on the right panel. Up to 30 pictures can be displayed on one page.

6. **Optional:** For the searched pictures, you can perform the following operations.

**Export** You can export one or more searched pictures.

**Picture**

- a. Click **Export Picture**.
- b. Check one or more picture(s), or check **Select All** on the page below.
- c. Click **Export** to export the selected picture(s) to local PC.

**View**

**Capture**

**Details**

Click a picture to view its capture details such as captured time and camera name.

---

## Note

You can click  to view an enlarged picture.

---

**Play**





**Related**

**Video**

Click **Playback** to play the picture's related video file (5s before and 5s after the capture) in the view window.

---

## Note

- You can click  to view the video in a larger window.
  - You can click  to adjust the play speed of the playback, click  to play back the video file frame by frame, and click  to enable audio.
- 

## 11.9.3 Retrieve Urban Management Event

After adding the device that supports urban management analysis, you can search the related events such as unregistered street vendor and packed package in the client. The event details include the captured picture and related video file. It is an intelligent way to help the urban management department to manage environment and improve the overall living quality of the city.

### Before You Start

You should have added the device to the client and properly configure the corresponding settings. See **Add Device** for details about adding the device.

### Steps

1. Click **Data Retrieval** → **Urban Management Event Retrieval** to enter urban management event retrieval page.
2. Click  to set the start time and end time for search.

### 3. Select a camera in the camera list.

---

#### **Note**

You can enter a key word (supports fuzzy search) in the search box to quickly find the target camera(s).

---

### 4. Select an event type such as unregistered street vendor and packed package from the drop-down list for search.

### 5. **Optional:** Set the maximum number of searched results to be displayed.

### 6. Click **Search** to start searching.

The captured pictures which meet the search conditions are displayed on the right panel. Up to 30 pictures can be displayed on one page.

### 7. **Optional:** For the searched pictures, you can perform the following operations.

**Export** You can export one or more searched pictures.

#### **Picture**

- a. Click **Export Picture**.
- b. Check one or more picture(s), or check **Select All** on the page below.
- c. Click **Export** to export the selected picture(s) to local PC.

#### **View**

#### **Capture**

#### **Details**

Click a picture to view its capture details such as captured time and camera name.

---

#### **Note**

You can click  to view an enlarged picture.

#### **Play**





#### **Related**

#### **Video**

Click **Playback** to play the picture's related video file (5s before and 5s after the capture) in the view window on the bottom right.

---

#### **Note**

- You can click  to view the video in a larger window.
- You can click  to adjust the play speed of the playback, click  to play back the video file frame by frame, and click  to enable audio.



## Chapter 12 AI Dashboard

The client provides AI Dashboard module through which you can experience the advanced functions of the devices with AI features, such as face comparison and linked capture of fixed camera and panoramic camera, traffic accident alarm, AI open platform to access to third-party applications.

### 12.1 Face Application

For some devices, such as DeepinMind NVRs, DeepinView cameras, and dual-lens camera, Face Application function provides showing face comparison alarm for the persons in the blocklist, VIP or regular costumers during live view. If the detected face pictures are matched with the persons in the blocklist or VIP face picture library, the security center will receive relative alarms to take appropriate actions quickly and effectively. It can also help you to evaluate the regular costumers, which is widely used in the hospital, supermarket, shopping mall and so on.

#### 12.1.1 Set List Types for Face Picture Libraries

You can configure list type for each face picture library of the device(s), so that the software can check whether the persons detected during live view are in the blocklist, very important person, or the regular costumers.

Click **AI Dashboard** → **Face Application** , and then click  in the upper-right corner to select the list type for each face picture library on the devices.

##### **Blocklist**

If the alarm type is set to **Blocklist**, AI dashboard will show the blocklist alarm once the captured pictures are matched with the ones in the face picture library.

##### **VIP**

If the face picture library is set to **VIP** , AI dashboard will show the VIP alarm once the captured pictures are matched with the ones in the face picture library.

##### **Normal**

The face pictures libraries which belong to neither blocklist nor the VIP can be set to **Normal**. AI dashboard will not show any alarms when the captured face pictures are matched with the ones in the face picture library.



##### **Note**

This function should be supported by the device and the face picture library need be configured in the device firstly.

---

### 12.1.2 Set Cameras for Showing AI Information

You can specify the displaying camera(s) or other cameras in the camera list to show AI information during live view. For example, if you select a camera (not in live view in the displaying window) for showing VIP information, this camera will perform static detection in the background and show the AI information about VIP.

Click **AI Dashboard** → **Face Application** , and then click  in the upper-right corner to select cameras for showing the AI information in real-time.

Select the alarm type to be displayed for different cameras: Blocklist Alarm, VIP Alarm or Regular Customer Alarm.

#### All Cameras in Live View

If check **All Cameras in Live View**, only the AI information of the camera(s) in live view in the displaying window can be shown.

#### Custom Cameras

If check **Custom Cameras** and select the desired cameras, the AI information of the selected camera(s) can be shown, whether the cameras are in live view or not.

### 12.1.3 Show AI Information

After setting the cameras for showing AI information and list type for face picture libraries, you can view the AI information.

Click **AI Dashboard** → **Face Application** , and then select the camera(s) from the camera list to start live view and show AI information.

---

#### Note

This function should be supported by the device.

---

#### Camera List

The camera list on the left panel shows all the resources added to the client software, and you can select the appropriate window division and desired camera(s) to show AI information.

---

#### Note



The channels for live view at the same time are limited by the performance of the PC running the client.

---

Right-click the camera in the camera list, you can switch stream type between main stream and sub-stream.

#### Display Intelligent Information on Live View

You can view the real-time video of the selected camera(s).

Click  in the global toolbar of the live view area and select the window to enable the desired intelligent display. For example, if the blacklist alarm is enabled for all live view windows, the recognized targets will be marked dynamically on the images of all windows. You can also click  at the bottom of each window to enable the intelligent display for the camera in this window.

## Face Comparison

If you set **Face Comparison** switch to ON, when detecting blacklist person, VIP, or regular customer, the related alarm notification with corresponding colors will list on the right panel. You can view the alarm time, camera, and other details of the alarm.

## Historical Captured Picture

You can view the historical captured pictures at the bottom of the page.

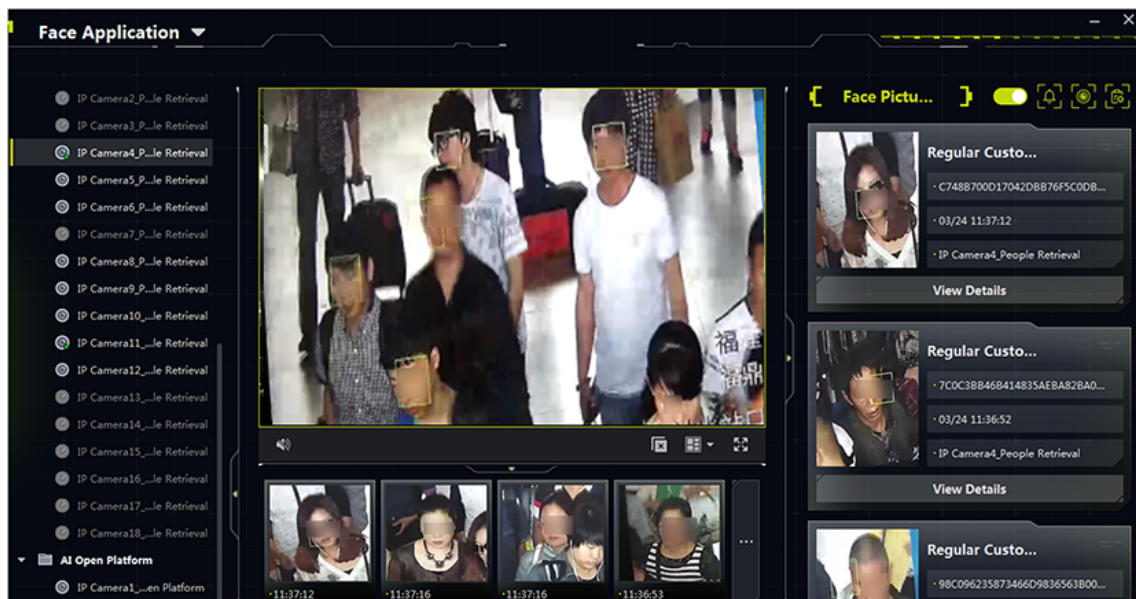



Figure 12-1 Show AI Information

## Enable Alarm Triggered Pop-up Window

Click  to enable alarm triggered pop-up window, and after that, a window will be pop up when the blacklist alarm is triggered, including the captured pictures and alarm details information.

## 12.2 Multi-Target-Type Detection

Multi-Target-Type Detection refers to a function that recognizing and capturing multiple types of detection targets including faces, human bodies, motor vehicles, and non-motor vehicles. When the device detects targets, you can view live view, captured pictures, and target features. Alarms can be triggered for high similarity between captured face/human body picture and the one in picture library, or high/low appearing frequency of a person/vehicle, or an appearance of a vehicle

in the blocklist, etc. It is often used in places such as crossroad and train station where there are large amount of people and vehicles showing and places requiring strong security.

### 12.2.1 Set Target Detection Parameters

The client supports customizing the display layout of detected targets and their details, selecting which feature to display with the detected targets, and selecting cameras of which alarms will be displayed.

#### Set Display Mode

You can customize the display layout and select information to display according to your needs.

##### Steps

1. Click **AI Dashboard** → **Multi-Target-Type Detection** .
2. Click  on the upper-right corner to open the Configure window.
3. Click **Basic Settings** tab.
4. Select a live view mode.
  - Select **Single Channel** to display one live view window.
  - Select **Dual Channels** to display two live view windows.
  - Select **Channel 4** to display four live view windows.
5. Check information to be displayed in the corresponding positions.



##### Note

- The **Face Arming** function should be supported by the device.
  - Up to 2 items can be selected to be displayed on the bottom of the page.
- 

The checked information will be displayed in the following window.

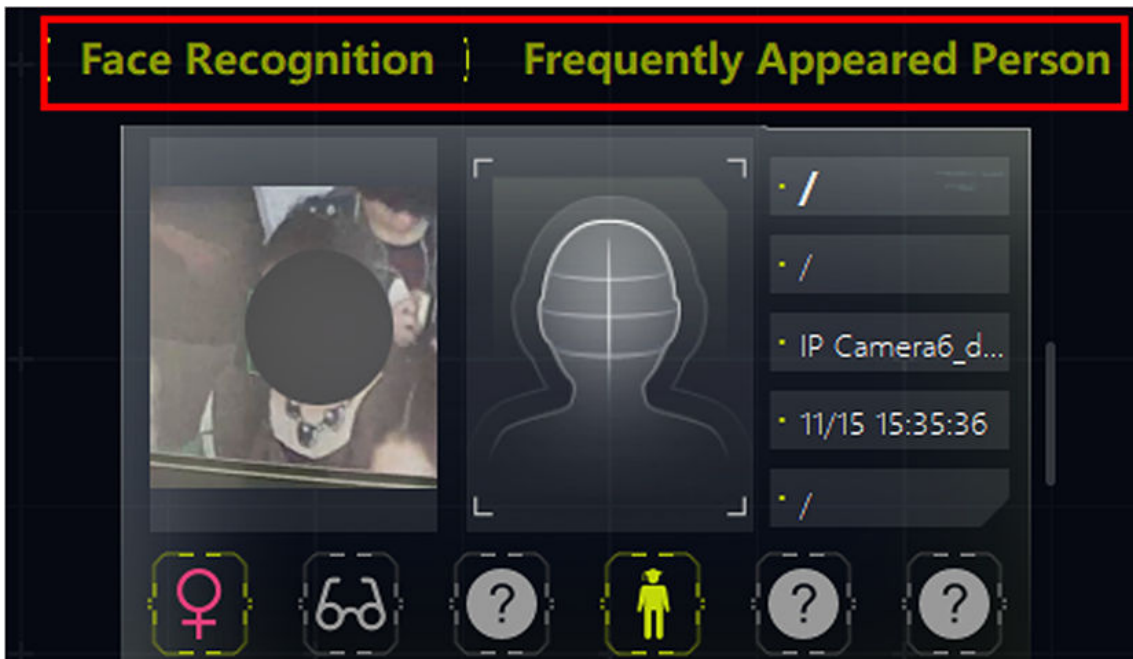

Figure 12-2 Display on Right

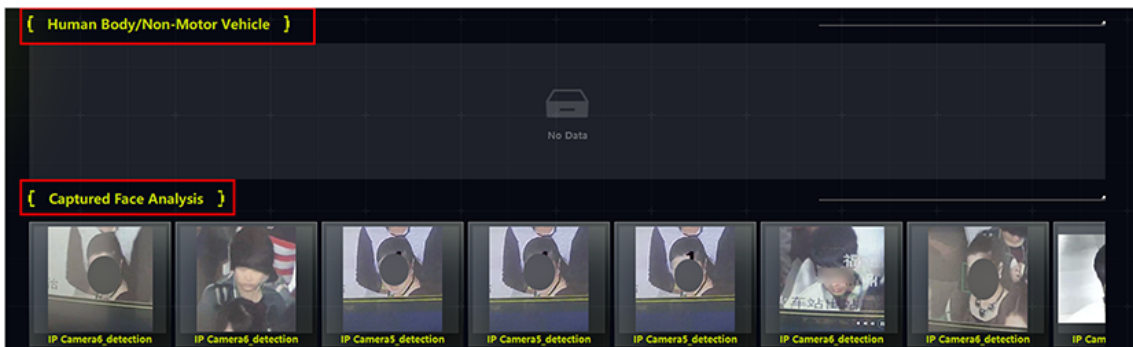

Figure 12-3 Display on Bottom

6. **Optional:** Enable **Save Picture** so that all the captured pictures will be saved in a specified folder and then click the saving path to change it.
7. Click **Save** to save the settings.

### Set Capture Parameters

For captured pictures, the device will analyze the features of the captured targets. You can select features to be displayed according to your needs. Take face detection as an example, you can select features such as age, gender, wear glasses to display with the picture.

#### Steps

1. Click **AI Dashboard** → **Multi-Target-Type Detection** .

2. Click  on the upper-right corner to open the Configure window.
3. Click **Capture Parameters** tab.
4. Enable **Display Features**.
5. Enable **Features in Face Detection/Features in Motor Vehicle Detection/Features in Human Body Detection/Features in Non Motor Vehicle Detection** and check corresponding features.

 **Note**

No more than 6 features of each function can be selected.

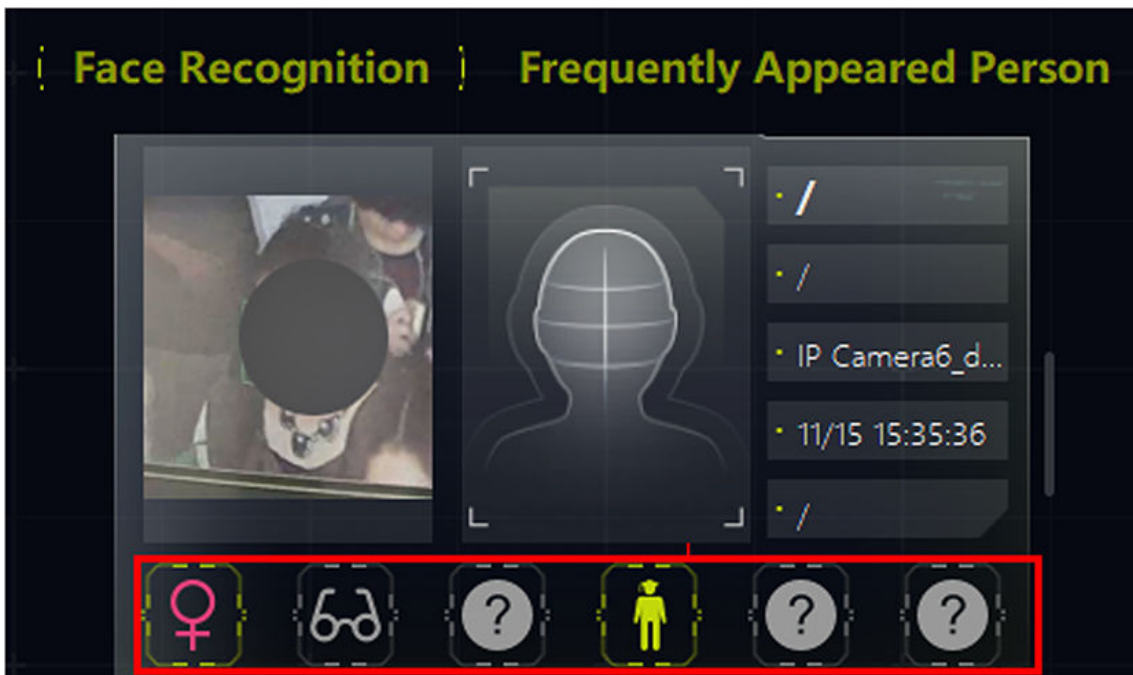

Figure 12-4 Displayed Features

6. Click **Save** to save the settings.

### Set Cameras Receiving Alarm

For cameras configured with detection alarm, you can select cameras to display their alarms on the right panel with detailed alarm information provided.

#### Before You Start

Make sure you have configured alarms for the cameras whose alarms you select to display.

#### Steps

1. Click **AI Dashboard** → **Multi-Target-Type Detection** .
2. Click  on the upper-right corner to open the Configure window.
3. Click **Receiving Alarm Settings** tab.
4. Check cameras whose alarms will be displayed on the right panel.



## Note

Alarms of checked cameras will be displayed on the right panel with detailed alarm information.

5. Click **Save** to save the settings.

## 12.2.2 Display Multi-Target-Type Detection

Multi-Target-Type Detection supports displaying detected information (including live view of capture cameras, captured pictures, target details, target amount, and alarm details) after configuring corresponding parameters.

## Note

This function needs to be supported by device.

## Live View

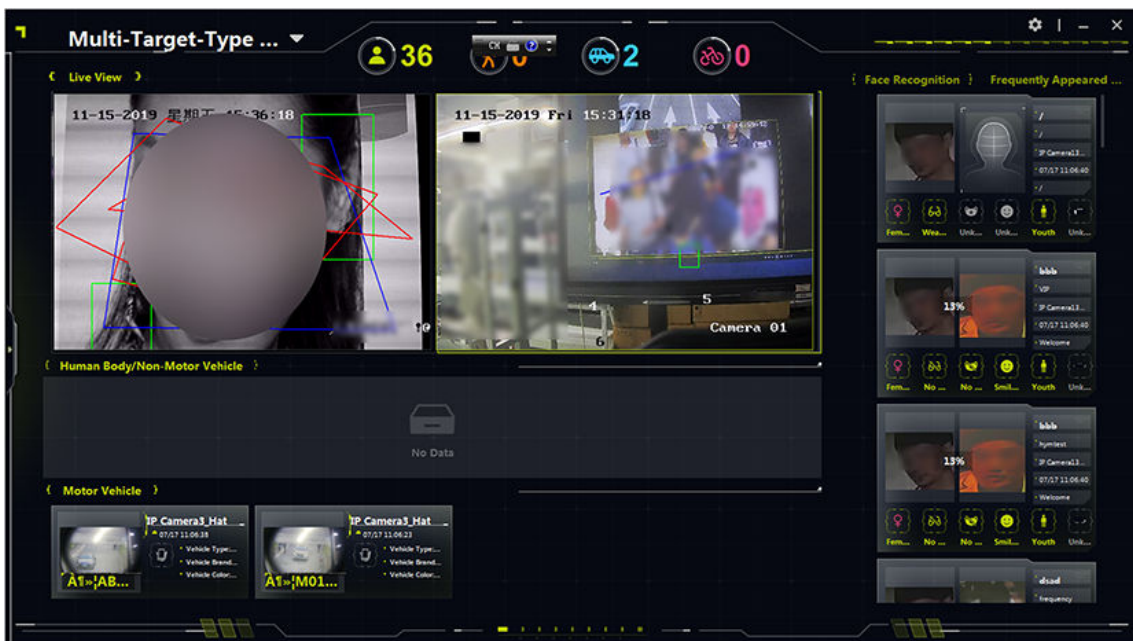

Figure 12-5 Multi-Target Detection Display

Supports displaying live view in single channel mode, dual-channel mode, or 4-channel mode. You can capture a picture or start recording quickly with tool bar in the live view window when something important happens. You can also perform PTZ control or 3D position by a right-clicking for a panoramic detailed view.

## Human Body/Non Motor Vehicle

Captured human body/non motor vehicle pictures will be displayed in this area with a highlight box on the target. Meanwhile, features of the captured target will be displayed with the pictures.

## Captured Face Analysis

Display captured face pictures with face features (such as age group, gender, glasses wearing, etc.) displayed.

## Motor Vehicle

Display captured motor vehicle picture with vehicle features (such as plate No., vehicle color, vehicle type, etc.) displayed.

## Facial Recognition/Frequently/Rarely Appeared Person

Display facial comparison or face arming results, captured face pictures of strangers, human body with captured face picture, and appearing frequency.

- Display captured face picture and the similar face picture in face picture library if the two faces match.
- Display captured face pictures that mismatched with that in the face picture library.

---

### Note



For a device supporting stranger recognition, the captured faces will be compared with pictures in face picture library. The person will be recognized as a stranger if her/his face matches with no faces in the face picture library.

- For captured human body pictures, the face picture of the person will also be displayed.
- Appearing Frequency: Frequently Appeared People will be displayed whose appeared times is larger than the threshold, while Rarely Appeared People will be displayed whose appearance amount is less than the threshold.

---

### Note

Person information including the last captured face picture, appearance amount, and alarm time will show after clicking the alarm information. You can add the detected person to face picture library.

- Display the human features of the detected persons. For example, the person who wears glasses is marked in highlight icon (  ), and the person who does not wear glasses is marked in highlight icon with diagonal (  ), and the undetected feature is marked in gray icon (  ).

## 12.3 AI Open Platform

AI Open Platform is a software platform that can be accessed to third-party software application, algorithm, etc. By this way, different intelligent objects can be connected by network, and more software developer can work efficiently on this platform.



### 12.3.1 Configure Platform Parameters

You can add intelligent devices to the client for displaying on the AI Open Platform. On the AI Open Platform, you can get model package, select the cameras to be displayed, set the saving path for picture storage and set the storage mode.

#### Configure Local Storage

You can select to save the alarm information and pictures to the local path, and set the saving path and storage mode.

##### Steps

1. Click **AI Dashboard**, and then select **AI Open Platform**.
2. Click  on the right-upper corner to open the Local Storage Settings window.
3. Set **Local Storage** to ON.
4. Click the entering box of **Saving Path** to select the saving path.



##### Note

Make sure the storage space is larger than 2 GB, otherwise the pictures can not be stored.

---

5. Select the **Storage Mode**.

##### **Overlap Earliest Alarm(Max. 10000 Alarms for Each Channel)**

In this mode, up to 10000 alarms (including pictures) can be stored for each channel, and if the storage space is full, the new alarm and pictures will overlap the earliest alarm.

##### **Do Not Overlap**

In this mode, up to 10000 alarms (including pictures) can be stored for each channel, and if the storage space is full, the new alarm and picture will not be saved.

6. Click **OK**.

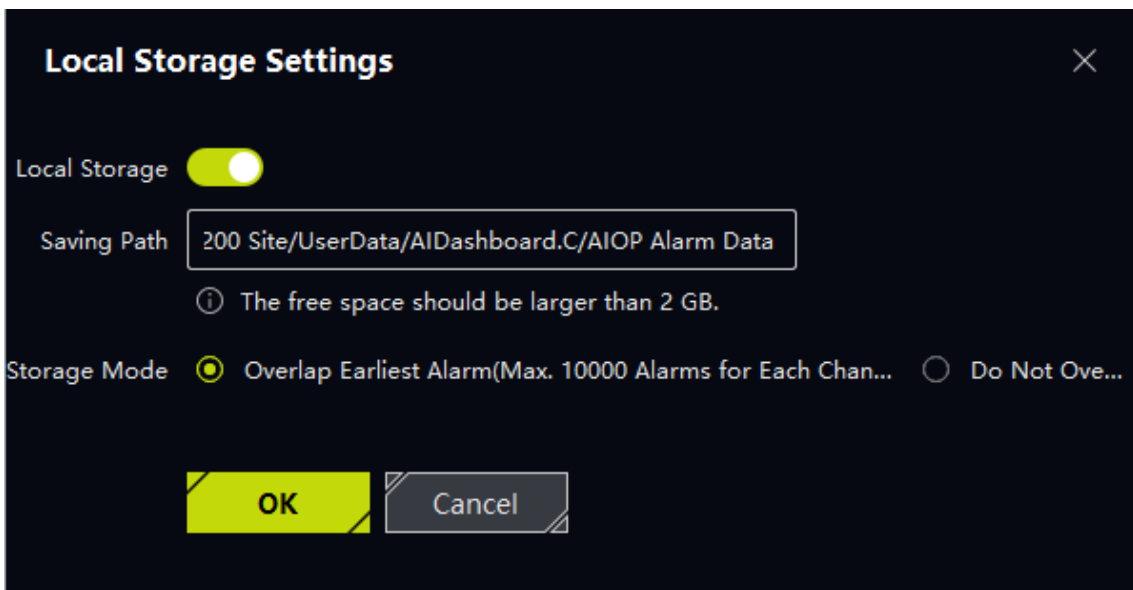



Figure 12-6 Configure Local Storage

## Get Model Package

Model package is a product generated by algorithm model training on AI Algorithm Training Platform. The model package can be imported to devices for task analysis. If the model package saved in device is modified, you can synchronize the model package from the device, to make the data information accordant.

### Steps

1. Click **AI Dashboard**, and then select **AI Open Platform**.
2. Click  on the right-upper corner to open the model package selecting window.
3. Check the cameras to get model package from the cameras.
4. Click **OK**.

## Set Objects to Be Displayed

By default, the AI Open Platform receives alarm information from all cameras and all tasks. You can also choose specific camera(s) or task(s) to display received alarms.

### Steps

1. Click **AI Dashboard**, and then select **AI Open Platform**.
2. Click  on the right-upper corner to open the camera(s) selecting window.
3. Choose the camera(s) or task(s) to display received alarms.
4. Click **OK**.

## 12.3.2 Analyze Picture Task

AI Open Platform can analyze and recognize objects in the picture(s). The client can apply the picture(s) to the device. The device will analyze the picture(s) and upload the results (e.g. object classification, attribute) to the client for displaying.

### Steps

1. Click **AI Dashboard**, and then select **AI Open Platform**.

2. Click  in the right-upper corner of the page.

The Picture Importing & Analysis window pops up.

3. Select the **Device** to analyze the offline picture(s).



Only the device supporting offline picture analysis function will be displayed in the drop-down list.

4. Select **Device Engine** or **Algorithm List** for selecting the model package.

5. Enter the path of folder, which stores the offline pictures for analyzing.



The supported picture format and size vary according to different devices.

6. **Optional:** Check **Display Alarm Target Frame** to display the frame on the target which is recognized.



If you select the **Device Engine** as OCR model package, the **Display Alarm Target Frame** function is gray, and you can not check this function.

7. **Optional:** Set the detection frame for the target to be analyzed, thus to improve the accuracy rate.



When selecting a single classification model package, the detection frame is required.

8. Click **Start**.

---

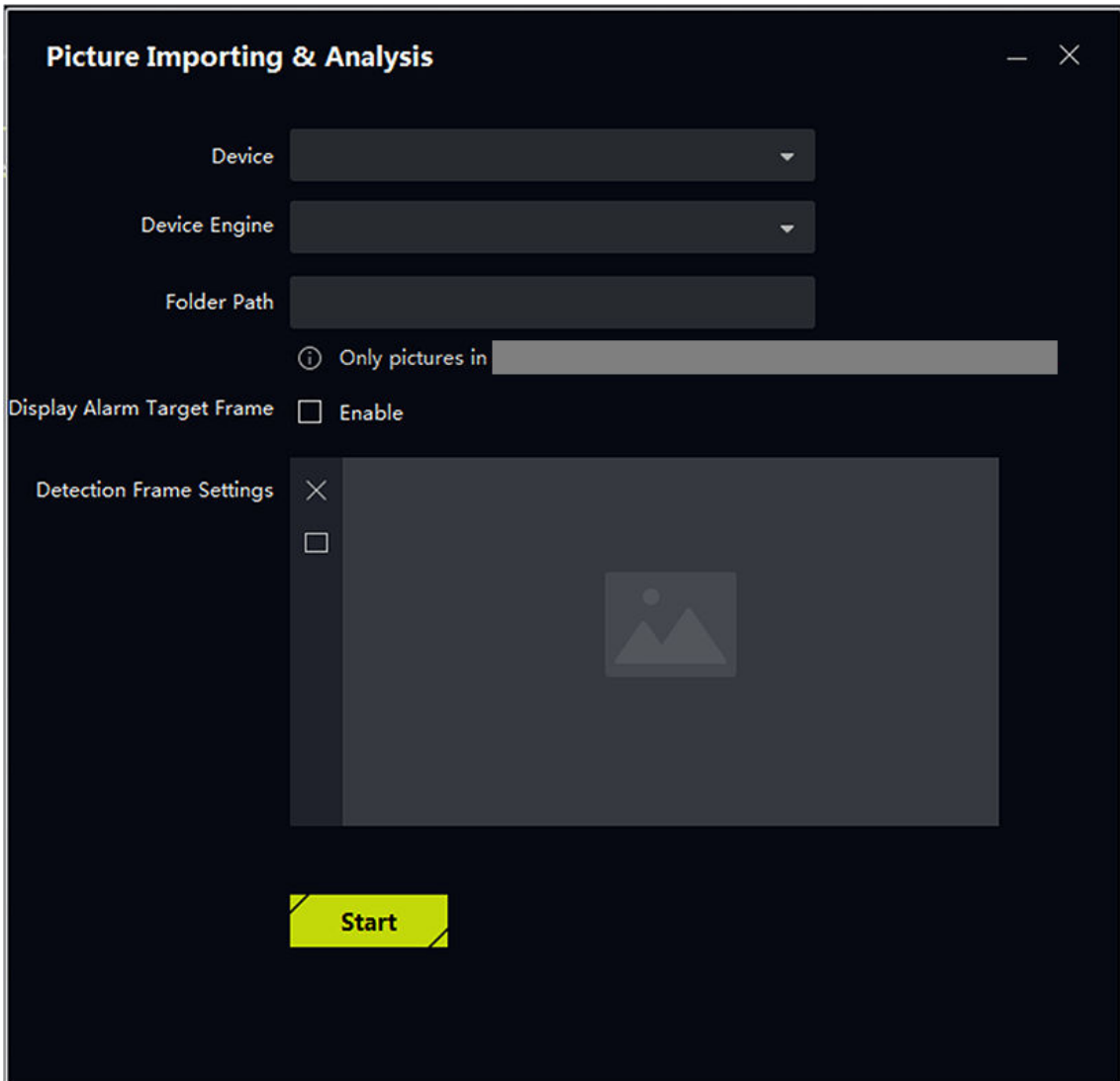

Figure 12-7 Picture Importing and Analysis

### 12.3.3 AI Platform Real-Time Display

The AI Platform can display the live video of the camera, and display the uploaded pictures and alarm information from the device.

#### Matched Results Display

On the AI Platform, the surveillance scene is compared with the scene learned by model to generate the result. In the **Matched Results** area, the results are displayed, including alarm pictures, camera information, alarm time, category, detection result, tags and attributes of the

target. When the object is recognized, you can move the cursor to the object to view the category or detection result, and click the alarm picture to view the details.

---

### Note

The alarms in the figure above is OCR alarm, which are uploaded to the client when the devices recognize characters in the video. If there are more than 3 characters recognized, only 3 characters are displayed, and you can click  to view more character(s) in the next page.

---

### Live View

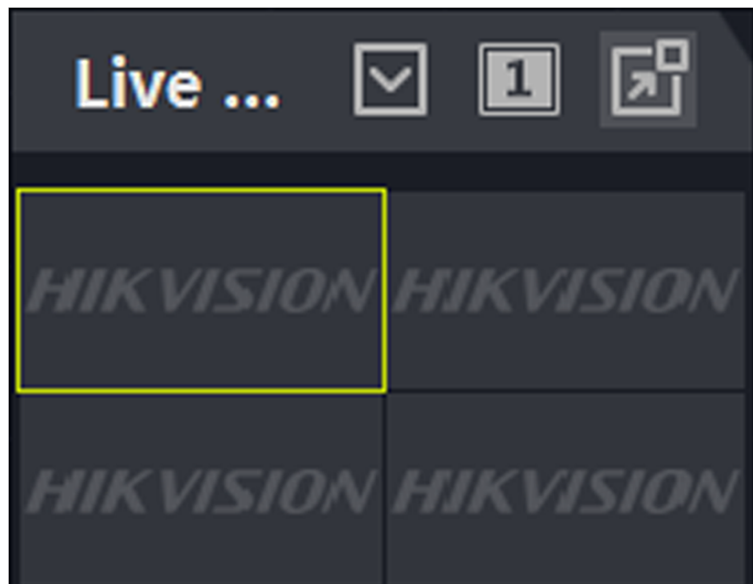

In the lower-left corner of the page, the live video of the camera is displayed.



**Figure 12-8 Live View in AI Open Platform**

Click  to switch the window division to 1 window or 4 window.

Click  to hide the live view window.

Click  to pop up the live view window. After the window is popped up, you can click  to display the window in full screen.

---

### Note

Live view is not supported by DeepinMind Server.

---

## 12.4 Linked Capture Alarm

This function allows the users to view two different channels (one fixed channel and one PTZ channel) of a device simultaneously. Therefore, you can view the panoramic image and captured details at the same time when an alarm is triggered.



This function needs to be supported by the device.

---

## 12.4.1 Set Basic Parameters

The capture saving function can be enabled or disabled manually, and you can also set the saving path of the captured picture, so that you can view the captured pictures in your PC.

### Steps

1. Enter the AI Dashboard module.
2. Select **Linked Capture Alarm** to open the Linked Capture Alarm window.
3. Click  to open the setting window.

The introduction of the displayed content shows.



4. Switch **Save Picture** on to enable picture saving function.
5. Click the **Saving Path** to select a saving path of the captured pictures.
6. Click **Save** to save the settings.

The pictures captured when events and alarms are triggered will be saved in the configured path.

## 12.4.2 View Live View and Alarms

When fixed camera triggers an alarm, the fixed camera will capture a panoramic picture related to the alarm, which will be displayed in the panoramic linked alarm window; and the linked PTZ camera will capture a picture with details about the alarm, and the picture will be displayed in the linked channel alarm window. In this way, the user views the panoramic image with details displayed simultaneously.

Generally speaking, Panoramic Channel Live View window is used to display the live view of fixed camera, while Linked Channel Live View window is used to display the live view of PTZ camera connected to the fixed camera.

1. Enter the **AI Dashboard** and select **Linked Capture Alarm** to open the Linked Capture Alarm window.
2. Click  to expand the device list.
3. Select a window and double-click a camera to start live view, or drag a camera from the device list to a window, or hover the cursor on a camera name and then click .

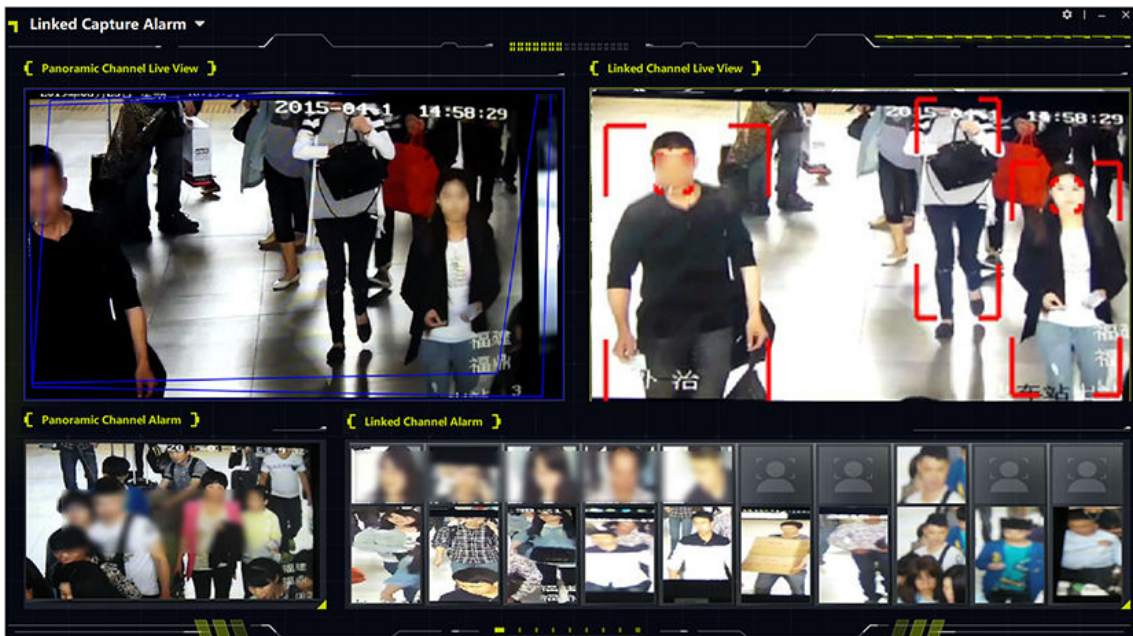

Figure 12-9 View Live View and Alarms

## 12.5 Traffic Accident Alarm

The intelligent traffic device (e.g. traffic speed dome) can be added to the client for real-time live view of the traffic violations or abnormal traffic events happened on the road. When the camera detects the accident, the camera will capture the picture and upload the picture and accident alarm to the client, which is convenient for the enforcement. The client can display the enforcement alarm, traffic accident alarm and road traffic alarm.

### 12.5.1 Object Missing

This object is not available in the repository.

### 12.5.2 View Traffic Accident Alarm

On the Traffic Accident Alarm Module, you can view the real-time traffic surveillance view, and receive the alarm information triggered by the traffic device. You can view the surveillance video by 1 channel or 2 channels, and display the enforcement alarms, traffic accident alarms or road alarms from the corresponding camera(s).

Select **AI Dashboard Traffic** → **Accident Event** to enter the Traffic Accident Event page.

Click  on the left of the page to select the cameras for live view.







## Live View Window

The live view window displays the real-time traffic surveillance video. Click 1 or 2 on the right-lower corner to set the window division. Up to 2 cameras can be viewed simultaneously.

### Note

Display live video of 1 or 2 cameras in main stream mode. Stream switch is not supported.

Click  or  on the right-lower corner of the live window, to manually record the video or capture picture of the camera.

## Display Traffic Event

Display the parameters information of traffic event, enforcement or road traffic event information in real-time. Up to 6 parameters can be displayed for each event, such as alarm time, vehicle type, event type, etc.

## 12.6 Arming and Tracking

For the devices that support arming and tracking, the devices can be configured in a designed order to detect and track the target (human or vehicle), and display the video or captured picture of the target on the client. This is suitable for the situation that the target (human or vehicle) should be continuously tracked. For example, the vehicle with traffic violation can be armed, and then it will be tracked and monitored by multiple cameras.







## 12.6.1 Vehicle Arming and Control

For the devices that support vehicle arming and control, the vehicle can be armed by license plate number on the device or on the client, and the devices can be installed and configured in a designed order to detect the armed vehicle and track this vehicle. When the first camera detects this vehicle (the recognized license plate number matches the armed one), the vehicle will be continuously tracked by the other cameras in the designed order, and the related videos and recognized license plate number will be displayed on the client to track this vehicle continuously.

### Before You Start



Make sure the devices support vehicle arming and control.

### Steps

1. Enter the AI Dashboard module, and then select **Arming and Control** to enter the Arming and Control module.
2. Click  to switch to **Vehicle**.
3. Click  to open the Configure window.
4. Click **Add Device** to add the devices to be armed.
5. Click  /  in the Operation column to adjust the order of the devices to be armed.
6. **Optional:** Click **Add License Plate** in the License Plate sheet to add the license plate number of the vehicle(s) to be armed.

---

### Note

- The vehicle can be armed both on the device and on the client. Only the vehicle that is not armed on the device should be armed here on the client.
  - Up to 100 license plate number can be added for arming.
  - Only the license plate number added in the latest time will be armed and take effect.
7. **Optional:** For the license plate number that do not need to be armed, click  in the Operation column to delete it.
  8. Click  to arm the devices.

The videos of the detected vehicle will be displayed.



The license plate number of the detected vehicle is displayed in the right-upper corner of the middle window.



Figure 12-11 Vehicle Arming and Control

### Note

- The video of the camera which detects the vehicle recently is always displayed in the middle window of the page. The previous video will be switched to the left by one window.
- For example, when camera1 recognizes the vehicle for the first time, the video of camera1 is displayed in the middle window. When camera2 recognizes the vehicle, the video of camera2 is displayed in the middle window, and the video of camera1 will be switched to the left window. When camera3 recognizes the vehicle, the video of camera3 is displayed in the middle window, the video of camera2 will be switched to the left window, the video of camera1 will be switched to the right window.

9. **Optional:** Click  to switch the view to the following video.
10. **Optional:** Click  to switch the view to the previous video.
11. **Optional:** If you want to disarm the device, click  to disarm the device.





### 12.6.2 Face/Human Body Arming and Control

For the devices that support face/human body arming and control, the person can be armed on the devices and the devices can be installed and configured in a designed order to detect the person and track the person. When the first camera detects this person (the facial picture or human body picture captured by the device matches the armed one), the person will be continuously tracked by the other cameras in the designed order, and the related videos and comparison result (captured picture and armed picture) will be displayed on the client to track this person continuously.

## Before You Start

Make sure the devices support arming and control, and the related face picture or human body picture are correctly armed on the device. For details, refer to the user manual of the device.

## Steps

1. Enter the AI Dashboard module, and then select **Arming and Control** to enter the Arming and Control module.
2. Click  to switch to **Face/Human Body**.
3. Click  to open the Configure window.
4. Click **Add Device** to add the devices to be armed.
5. Click  /  in the Operation column to adjust the order of the devices to be armed.



The videos of the detected person will be displayed on the middle window and right window. The comparison result (the captured facial picture, the armed picture and similarity) will be displayed on the left window.



Figure 12-12 Face/Human Body Arming and Control

## Note

The video of the camera which detect the person recently is always displayed in the middle window of the page. The previous video will be switched to the right window.

6. **Optional:** Click  to switch the view to the following video.
7. **Optional:** Click  to switch the view to the previous video.

## 12.7 Skin-Surface Temperature

In some special scene, you can supervise the human body's skin-surface temperature. When the Client receives alarm information of abnormal skin-surface temperature or no mask, it will trigger the linkage of alarm audio or pop-up window. This is suitable for the scene that requires people wearing mask and skin-temperature measurement.

### Note

The function should be supported by the devices.

### 12.7.1 Display Skin-Surface Temperature

In the Skin-Surface Temperature page, you can view the persons in the live view, and get the statistic number of the persons whose temperature are abnormal, normal and the persons do not wear mask. You can also view the alarm information of the face picture comparison, temperature measurement picture, face capture alarm, and the historical captured face pictures.

Click **AI Dashboard** → **Skin-Surface Temperature** to enter the Skin-Surface Temperature page. Start live view in the Skin-Surface Temperature page.



- Click  on the left panel and double-click the camera to display the live video of the camera.
- Click  on the left panel, and then click  on the right side of the camera to display the live video of the camera.



Figure 12-13 Skin-Surface Temperature Page

## 12.7.2 Skin-Surface Temperature Information Display

In the Skin-Surface Temperature page, you can select the alarm types (face comparison alarm, temperature measurement picture and face capture alarm) to be displayed on the right area. The statistic number of persons are displayed on the top of the page. The captured face pictures are displayed on the bottom of the page. You can set the audio linkage file for received alarms.

### Enable Information Display

You can select the alarm types (face comparison alarm, temperature measurement picture and face capture alarm) to be displayed on the Client. The alarm types are distinguished by different color.

1. In the Skin-Surface Temperature page, click  to select the alarm type(s) to be displayed.

#### Face Comparison Alarm

After enabled, the captured face picture and the comparison picture in the face picture library will be displayed, as well as the related classification (e.g. person name, stranger or unrecognized) in the library. Click **View Details** to view the detailed person information, including person name, gender, ID No., etc.

#### Temperature Measurement Picture

After enabled, the measured temperature will be displayed on the captured face picture, and the alarm is distinguished as normal or abnormal by different color.

#### Face Picture Alarm

Display the captured face picture detected in the detection area.

2. Set **Display** switch to ON to display the event information in the right area.

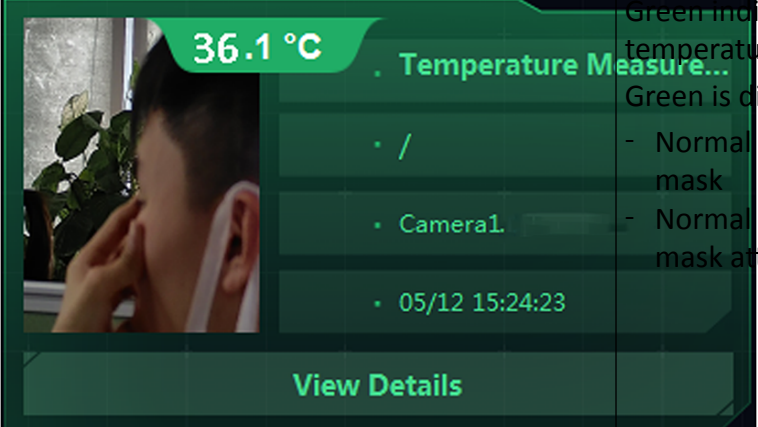

**Table 12-1 Descriptions of Different Color**

Picture	Description
	<p>Blue indicates no temperature information. Blue is displayed in the following cases:</p> <ul style="list-style-type: none"> <li>- No skin-surface temperature information + wear mask</li> <li>- No skin-surface temperature information + the mask attribute is not detected by the device</li> </ul>
	<p>Green indicates the person is normal temperature. Green is displayed in the following cases:</p> <ul style="list-style-type: none"> <li>- Normal skin-surface temperature + wear mask</li> <li>- Normal skin-surface temperature + the mask attribute is not detected by the device</li> </ul>

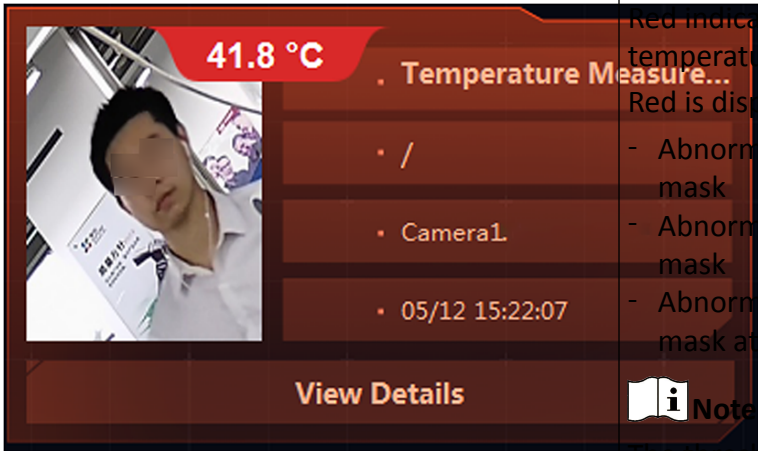
Picture	Description
	<p>Yellow indicates the person does not wear mask. Yellow is displayed in the following cases:</p> <ul style="list-style-type: none"> <li>- No mask + normal skin-surface temperature</li> <li>- No mask + the device does not support temperature measurement function.</li> </ul>
	<p>Red indicates the person's skin-surface temperature is abnormal. Red is displayed in the following cases:</p> <ul style="list-style-type: none"> <li>- Abnormal skin-surface temperature + wear mask</li> <li>- Abnormal skin-surface temperature + no mask</li> <li>- Abnormal skin-surface temperature + the mask attribute is not detected by the device</li> </ul> <p><b>Note</b> The threshold of the skin-surface temperature abnormal can be set on the device.</p>

### Statistic Number of Persons

In the Skin-Surface Temperature page, the Client calculate the number of persons based on the received alarms, to get the number of passing persons, the number of persons whose skin-temperature are abnormal and the number of persons who do not wear mask.

 **Note**

Turn the **Display** switch to ON to get the real-time statistic number of persons.

- All: the total number of alarms received in the Skin-Surface Temperature page.
- Abnormal: the number of persons whose skin-temperature are abnormal. When a camera detects a person whose skin-temperature is abnormal, it will trigger the alarm of abnormal temperature, and the number of Abnormal and All will be added by 1.

- **No Mask:** the number of persons in the live view who do not wear mask. When a camera detects a person who does not wear mask, it will trigger the alarm of no mask, and the number of No Mask and All will be added by 1.
- **Normal:** the number of persons in the live view whose skin-temperature is normal. When a camera detects a person whose skin-temperature is normal, it will trigger the alarm of normal temperature, and the number of Normal and All will be added by 1.

### Captured Face Pictures Display

On the bottom of the Skin-Surface Temperature page, the captured face pictures can be displayed in real-time.

---

#### Note

- Turn the **Display** switch to ON to receive and display the captured face pictures in real-time.
- The displayed pictures are the captured face pictures for the face comparison alarm, temperature measurement alarm or face capture alarm. Make sure at least one alarm is selected by clicking .

---

Drag the slider under the captured face pictures to view the previous captured face pictures. On the bottom of the captured face picture, click  to add the face picture to the face picture library and enter the person information.

### Audio Linkage Settings

You can set audio linkage file(s) for the received alarms.

1. Click  on the upper-right corner of the Skin-Surface Temperature page.
2. Set the switch(es) to ON to enable audio linkage for different alarms.

---

#### Note

By default, audio linkages of all the alarms (no mask, normal temperature, abnormal temperature) are enabled.

3. Click  to select the audio file in .wav format to modify the audio file.

---

#### Note

Upload the audio file to the designed path of the Client. In **Audio Configuration** window, click  to view the designed path of the Client.

---



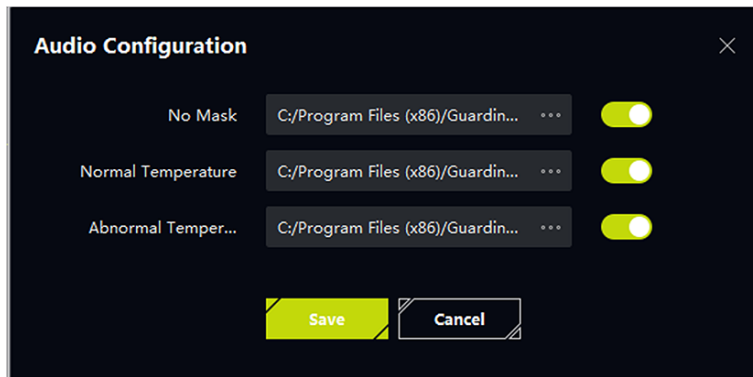

Figure 12-14 Audio Configuration

### 12.7.3 View Alarm Information

When the devices detect alarm of abnormal skin-surface temperature or no mask, it will trigger alarm pop-up window to display the alarm information. Besides, the duration of window pop-up can be set, which can help you to flexibly control the duration of viewing the alarm information.



Figure 12-15 Alarm Pop-up Window

#### No Mask

The alarm window pops up to show the captured face picture of the person who does not wear mask.

#### Abnormal Temperature

The alarm window pops up to show the captured face picture of the person whose skin-surface temperature is abnormal.

---

## Note

The priority of abnormal temperature alarm is higher than the priority of no mask alarm. If No Mask and Abnormal Temperature are both enabled, when the client receives the alarm of no mask and abnormal temperature, the abnormal temperature alarm window will pop up and the audio of abnormal temperature (if enabled. Refer to [Skin-Surface Temperature Information Display](#) for details.) will be played.

---

## Note

- Before viewing alarm information, make sure enabling receiving alarm information. For details, refer to [Enable Receiving Event from Devices](#) .
- Before receiving alarm window pop-up, make sure enabling alarm pop-up window. In the skin-surface temperature page, click  on the upper-right corner to pop up the window of **Alarm Pop-up Window** to set the configuration.

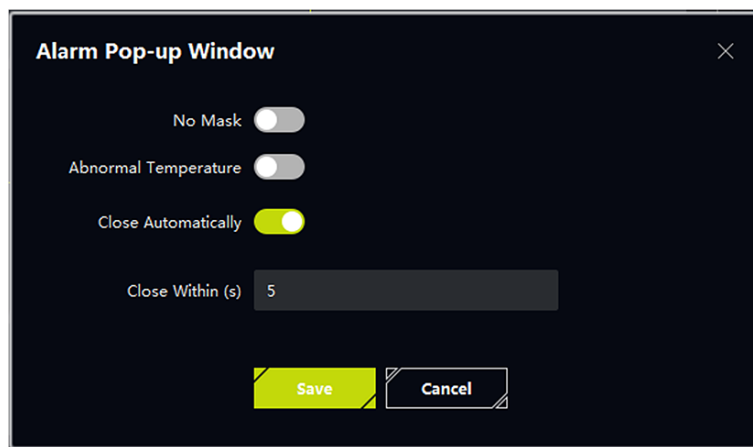

Figure 12-16 Alarm Pop-up Window Configuration

---

## 12.8 Behavior Analysis

The behavior analysis server can be added to the client to display the analysis results of multiple analysis tasks. The following analysis tasks are supported: perimeter prevention related alarms (e.g. line crossing detection, intrusion detection, parking detection), street behavior related alarms (e.g. , getting up detection, climbing alarm), indoor behavior related alarms (e.g. in-toilet overtime, absence detection), and people density analysis, etc. The analysis results (alarms) will be displayed.

Enter the AI Dashboard module, and then select **Behavior Analysis** to enter the Behavior Analysis page. In the task list, double-click the task, or select and drag the task to the live view window, and the video of the task will be displayed in the live view window.

The people density analysis results are displayed by 3 parts in the same window. The live video is displayed in the upper-left part of the window. The heat map of the video is displayed in the upper-right part of the window. The number of people is displayed in the bottom part of the window in real time.

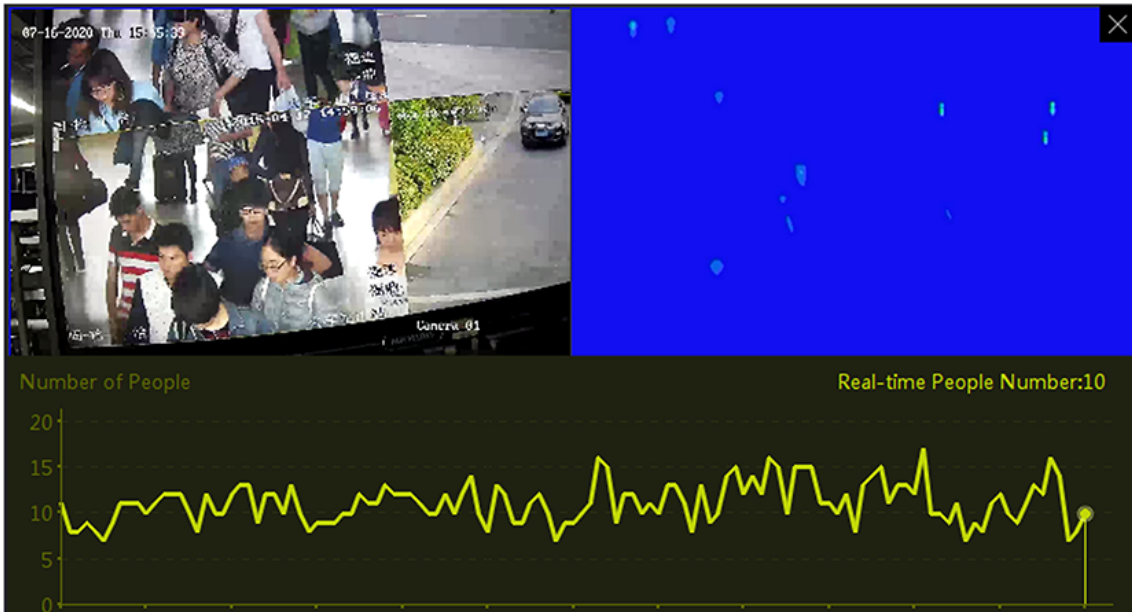

Figure 12-17 People Density Analysis Task Display

For the other tasks (not people density analysis task), only the task related video is displayed in the window.





Figure 12-18 Other Analysis Task Display

- Click the view and then click **Capture** to capture the picture of current video.
- Click the view and then click **Start Recording** to record the video.

---

### **Note**

The video is saved in the path that is configured in the System Settings module. For details about setting the path to save video, refer to [\*\*\*Set File Saving Path\*\*\*](#).

- 
- Click  to end the live view of the video.
  - Click  to change the window division of the video. Up to 6 windows are supported to be viewed simultaneously.
  - Click  to view the video in full screen.

## 12.9 Behavior Analysis Overview

When the behavior analysis server detects events, the client can receive the events from the server. The client can calculate the number of different events, the event time distribution and risk assessment (the total number of events and frequently-occurred events of different tasks), and display the statistic data in the same page, to help you get a overview of the behavior events. For example, if one event was mainly detected in a certain time period, you can investigate the reason in that time period and adopt measures to solve the problem.

### Set Filter Conditions

Enter the AI Dashboard module, and then select **Event Dashboard** to enter the Event Dashboard module. Click  to set the filter condition as follows:

#### Device

Select the behavior analysis server to display its events statistic data.

---

### **Note**

Only the behavior analysis server can be selected here.

---

#### Event Type

Select the event(s) to be calculated and displayed.

#### Statistic Time

Display the statistic data of the events in last 7 days or last 31 days.

#### Refresh Frequency

Get the statistic data of the events from the devices every 0.5 hour or 1 hour.

## Behavior Analysis Overview

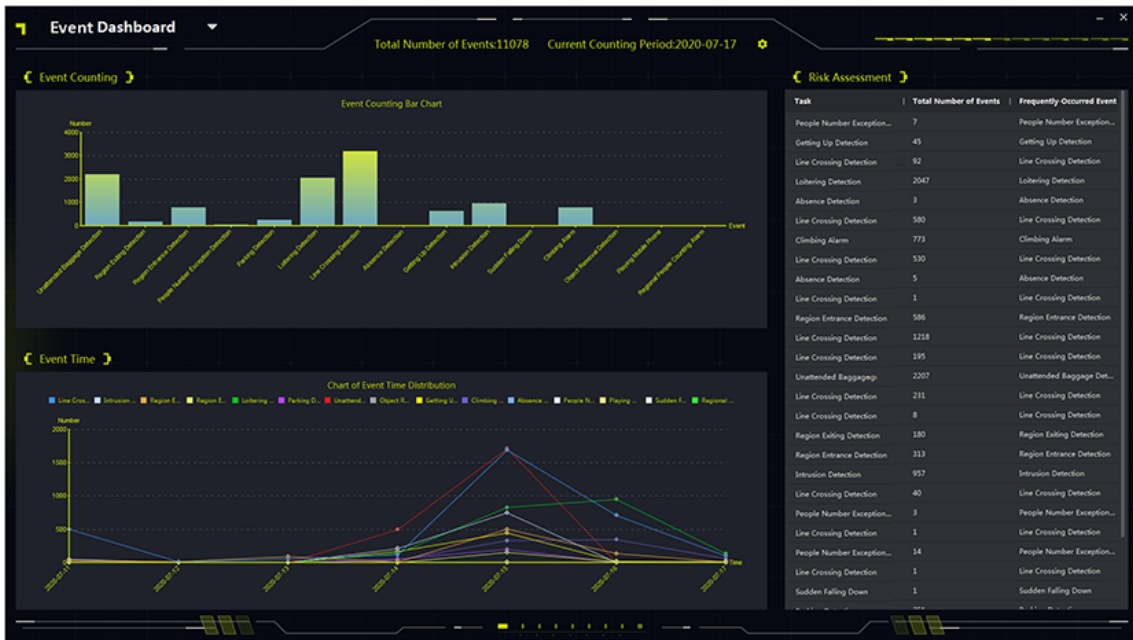

Figure 12-19 Behavior Analysis Overview

### Event Counting

In the bar chart, display the number of different events in bar chart. You can view the event that happened a lot and mainly investigate the reason that caused this event.

### Event Time

In the line chart, display the time distribution of different events in last 7 days or 31 days. You can view the date that the events happened a lot and mainly investigate the reason that caused the events in this date.

### Risk Assessment

In the list, display the total number of events and frequently occurred events of different tasks.

## 12.10 Customer Traffic (Face)

Customer Traffic (Face) function includes live view and real-time statistics display of customer traffic. The real-time statistics includes the number of people enter or exit, gender percentage, age group percentage and the real-time people number. Accurate business strategies can be provided by analyzing the customer traffic statistics to boost store operation efficiency.

---

## Note

- This function should be supported by the device.
  - For the historical data of customer traffic, refer to ***People Counting Report by Encoding Device*** .
- 

Click **AI Dashboard** → **Customer Traffic (Face)** .



## **Customer Traffic (Face) Live View**

1. Select camera(s) in the left list, double click the selected camera or drag it to the live view window to view its live view.
  2. Perform the following operation(s) if needed.
    - Click , select one window division mode.
- 

## Note

Supports up to 4 window divisions.

---

- Click  to stop all of the live view cameras.
  - Click  to display the live view in full screen. Press **Esc** key to exit full screen mode.
- 

## **Customer Traffic (Face) Real Time Data**

Click **Enter** or **Exit** to view the total number, gender statistics, age group statistics, real-time number for the people enter or exit.

### **Number of People Enter/Exit**

Display the number of people enter or exit within 24 hours. Check **Display All Types** to view the total number.

### **Gender Statistics**

Display the total number of people enter or exit within 24 hours and the gender percentage.

### **Age Group Statistics**

Display the percentage of each age group (such as the young, the middle-aged) in line chart within 24 hours for the people enter or exit.

### **Real Time People Number**

Display the real-time number of people enter or exit reported by the device within 24 hours.

---

## Note

You can log in to the web browser to configure the report interval. For details, refer to the user manual of the device.

---

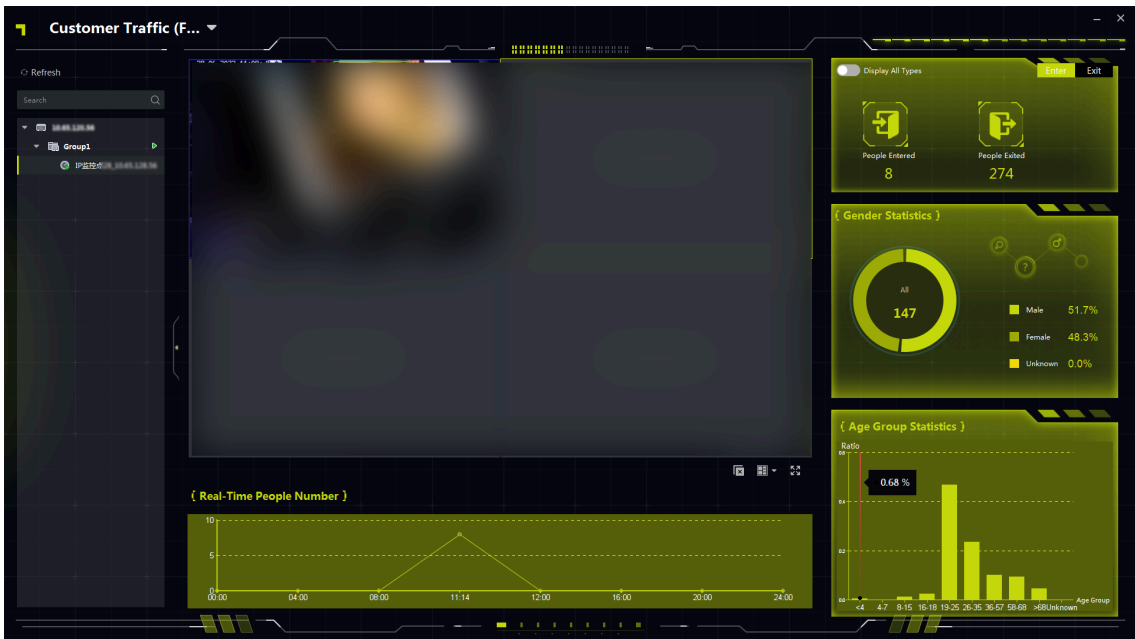

Figure 12-20 Customer Traffic (Face)

## Chapter 13 Security Control Panel

The Security Control Panel module provides remote control and configuration of the partitions and zones via the client software.

### Note

For the users with security control panel permissions, they can enter the Security Control Panel module to manage the security control panel and real-time alarm. For setting the user permission of Security Control Panel module, refer to ***Add User***.

### 13.1 Flow Chart

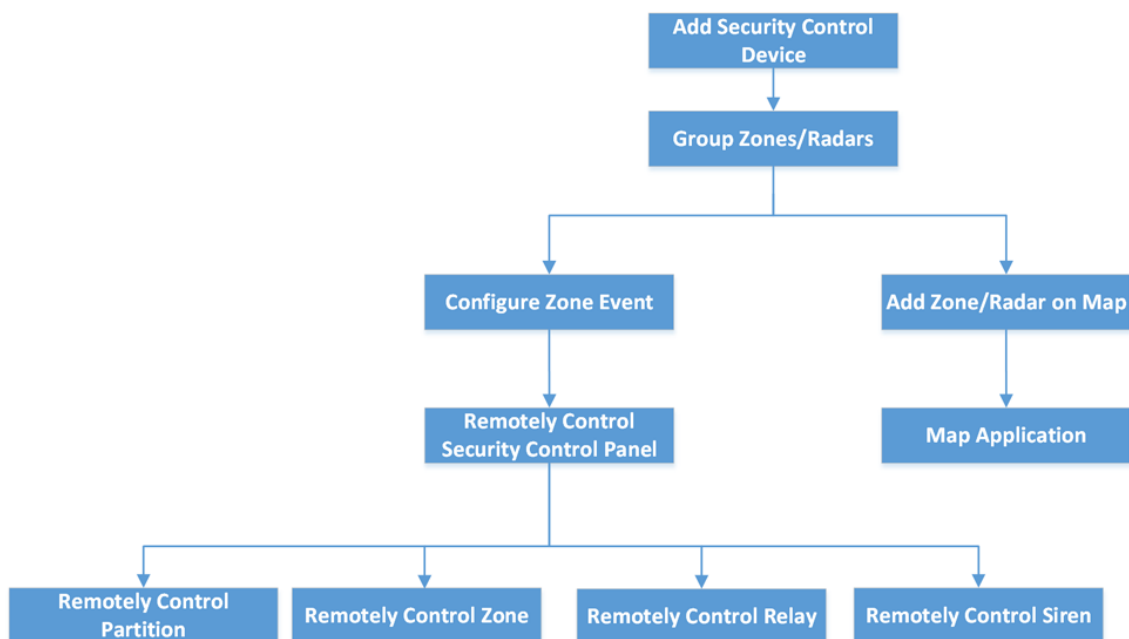

Figure 13-1 Flow Chart of Security Control Panel

- **Add Security Control Device:** You can add security control devices on the client. For more details, refer to ***Add Device***.
- **Group Zones/Radars:** You can group the added zones/radars into groups for convenient management. For more details, refer to ***Group Management***.
- **Configure Zone Event:** By configuring linked actions of zone event on the client, you will be notified once the event is triggered. For more details, refer to ***Configure Client Linkage for Zone Event***.
- **Remotely Control Security Panel:** You can remotely security control panel, including partition, zone, relay, and siren. For more details, refer to ***Remotely Control Security Control Panel***.



- **Add Zone/Radar on Map:** You can add zone/radar to the map as hotspots. For more details, refer to ***Add Zone as Hot Spot*** and ***Add Security Radar as Hot Spot*** .
- **Map Application:** You can locate the resources, view alarm information and perform related control. Refer to ***Map Management*** .

### 13.2 Object Missing

This object is not available in the repository.

### 13.3 Configure Client Linkage for Zone Event

Even if you are far away from a zone, you can still know what happens and how urgent the event is in a zone by configuring linked actions of zone event on the client. You will be notified on the client once an event is triggered, so that you can response to the event instantly. You can also configure client actions of multiple zones in a batch at a time.

#### Before You Start

- Make sure you have added a security control panel.
- Make sure zones have been defined beforehand.
- Make sure events have been configured beforehand.

#### Steps

1. Click **Event Configuration** → **Alarm Event** .
2. Expand the zone list of a security control panel, and then select a zone from the list.
3. Check one or more event.
4. Click **Edit Linkage** to configure client actions.

#### Audible Warning

The client software gives an audible warning when an event is triggered. You can select the alarm sound for audible warning.



#### Note

Click **Add** to enter the alarm sound name and select a sound in your PC. For details, refer to ***Set Alarm Sound*** .

---

#### Send Email

Send an email of the alarm information to one or more receivers.

For details about setting email parameters, refer to ***Set Email Parameters*** .

#### Pop-up Window

Pop-up window to display the event related information (including event details, captured pictures of the linked camera, process record, and process field) on the software client when the event is triggered.

## Display on Map

When the event source is added as a hot spot on the map, the hot spot will be displayed with red number (indicates the number of events, and the maximum number is 10) aside when the event is triggered, which helps the security guard to view the location of the event.

You can also click the hot spot to view the event details and the live video of the linked camera (s).

## Linked Camera

Link the selected camera(s) to capture picture when the zone event is triggered.

Select the camera(s) in the drop-down list.



### Note

Up to 4 cameras can be selected as the linked cameras for a zone event.

5. **Optional:** Click **Edit Priority** to set event priority as Uncatergorized/Low/Medium/High.
6. **Optional:** Click **Copy to...** to copy the event settings (including event priority, triggered client actions, and enabling/disabling the event) to other zones.
7. Configure linkage camera and linkage PTZ.



### Note

- The linked camera will turn to the selected preset or perform the selected patrol or pattern when an alarm is triggered in the radar's detection area.
- This function needs to be supported by the device.

- 1) Check cameras in the linked camera list.
- 2) Switch the **Linkage PTZ** on to enable the function.  
The cameras linked to the radar displayed below.
- 3) Select a camera and select **Preset/Patrol/Pattern** from the drop-down list on the right.  
The **Preset/Patrol/Pattern** list is displayed.



### Note

Make sure you have configured presets, patrols, or patterns for the camera.

- 4) Select a preset, patrol, or pattern.
8. Click **OK**.
  9. **Optional:** Enable or disable client actions for zone event.
    - Click **Enable All** or **Disable All** to enable or disable client actions of all zone events.
    - Switch **Enable** to ON/OFF to enable or disable client actions of one zone event.

## Enable Client Actions

When client actions are enabled, client actions will be triggered when client receives zone event.

## Disable Client Actions

When client actions are disabled, client actions will not work and actions will not be triggered when client receives zone event.

10. Click **Save**.

## 13.4 Remotely Control Security Control Panel

After adding the security control panel to the client, you can remotely control the partitions, zones, relays, and sirens of security control panel via the client software. For instance, you can arm, disarm, bypass, group bypass, etc. for both partitions and zones, and you can enable or disable relays.

---

### Note

- The displayed interface is subject to the types of added security control panels.
  - By default, AX Hub device uses HTTP port, and it does not support private ports.
- 

### 13.4.1 Remotely Control Partitions

You can perform operations remotely on security control panel's partitions using the client such as away arming, stay arming, instant arming, disarming, clearing alarm, group bypass, and recovering group bypass.

#### Steps

---

### Note

- The supported functions are subject to the added devices.
  - If a zone of a partition does not work, you should bypass it before arming/disarming the partition, and then recover bypass when the zone works.
- 

1. Enter **Security Control Panel** module.

2. Select a security control panel and click **Partition**.

The name, status, arming status and linked zone of the partitions will be displayed in the list.

3. Select one or multiple partitions and click the following button(s).

#### **Away Arming**

An arming mode that works when all persons are absent from the monitored region. When away arming is enabled, all zones of the partition work properly.

#### **Stay Arming**

An arming mode that works when persons stay in the monitored region. When stay arming is enabled, zones inside of the region are armed while zones outside of the region will be bypassed where you can move in the zones without triggering any event.

#### **Instant Arming**

After arming a partition, its zone will alarm instantly when an event is triggered.

#### **Disarming**

All the zones (except 24-hour zones) in the partitions does not work any more after clicking, so that no event will be triggered in the disarmed zones.

---

### **Note**

24-hour zones (e.g. 24-hour annunciating zones, 24-hour silent alarm zone, etc.) still can detect events and then alarm even if the partition is disarmed.

---

### **Clear Alarm**

Stop the alarming of alarming devices.

### **Group Bypass**

Bypass all the zones in one or more partition so that no event will be triggered in the bypassed zones before group bypass recovery.

---

### **Note**

You should disarm the partition before bypassing it.

---

### **Group Bypass Recovery**

Recover a group bypass to make all the zones in a partition work, so that you can arm the group.

## **13.4.2 Remotely Control Zones**

You can use the client to remotely control the security control panel's zones including bypassing and recovering bypass.

### **Steps**

**1.** Enter **Security Control Panel** module.



**2.** Select a security control panel and click **Partition**.

The name, status, arming status and linked zone of the partitions will be displayed in the list

**3.** Click  to open the Zone Operation panel.

The zones linked with the partition, zone No., zone name, zone status, zone alarm status, battery will be displayed.

**Zone Operation**

 Bypass  Bypass Recovered

<input checked="" type="checkbox"/>	Zone No.	Zone Name	Zone Status	Zone Alarm Status	Battery
<input checked="" type="checkbox"/>	1	Wireless zo...	Unassociated	Normal	Invalid
<input checked="" type="checkbox"/>	2	Wireless zo...	Unassociated	Normal	Invalid
<input checked="" type="checkbox"/>	3	Wireless zo...	Unassociated	Normal	Invalid
<input checked="" type="checkbox"/>	4	Wireless zo...	Unassociated	Normal	Invalid
<input checked="" type="checkbox"/>	5	Wireless zo...	Unassociated	Normal	Invalid
<input checked="" type="checkbox"/>	6	Wireless zo...	Unassociated	Normal	Invalid
<input checked="" type="checkbox"/>	7	Wireless zo...	Unassociated	Normal	Invalid

Figure 13-2 Zone Operation

**Zone Status**

Zone status can be unassociated, armed, disarmed, fault, shield, tamper-proof, etc.

**Battery**

The power of a zone's detector.

4. Check one or more zone in the list and click the following buttons.

**Bypass**

When a zone is bypassed, no event will be triggered in the zone, and you are not allowed to arm or disarm the zone, while other zones can be armed or disarmed.

**Note**

You should disarm the zone before bypassing it.

---

**Bypass Recovery**

After recovering bypass for a zone, you can arm it.

**13.4.3 Remotely Control Relay**

You can use the client to remotely change the on/off status of relay, and view the linked event of the relay.

**Steps**

1. Enter **Security Control Panel** module.

2. Select a security control panel, and then click **Relay**.

The name, status, and linked event of the relay will be displayed.

3. Check one or multiple relays and click **Open** or **Close**.



### Note

For AX Hub, you should set the **Relay Associated Event** as **Manual Control** in Device Management module.

---

### 13.4.4 Remotely Control Siren

You can control the siren status via the client remotely, including open and close. When the status of the siren is open, the detected alarm will trigger the alarm sound on the siren.

Enter **Security Control Panel** module, select a security control panel , and click **Siren** tab. Select one or multiple sirens, click **Open** or **Close** to open or close the sirens.

## Chapter 14 Person Management

You can add person information to the system for further operations such as access control, video intercom, time and attendance, etc. You can manage the added persons such as issuing cards to them in a batch, importing and exporting person information in a batch, etc.

### 14.1 Add Organization

You can add an organization and import person information to the organization for effective management of the persons. You can also add a subordinate organization for the added one.

#### Steps

1. Enter **Person** module.
2. Select a parent organization in the left column and click **Add** in the upper-left corner to add an organization.
3. Create a name for the added organization.

---

#### Note

Up to 10 levels of organizations can be added.

- 
4. **Optional:** Perform the following operation(s).

**Edit Organization**      Hover the mouse on an added organization and click  to edit its name.

**Delete Organization**      Hover the mouse on an added organization and click  to delete it.

---

#### Note

- The lower-level organizations will be deleted as well if you delete an organization.
- Make sure there is no person added under the organization, or the organization cannot be deleted.

---

**Show Persons in Sub Organization**      Check **Show Persons in Sub Organization** and select an organization to show persons in its sub organizations.

### 14.2 Add Single Person

You can add persons to the client software one by one. The person information contains basic information, detailed information, profiles, access control information, credentials, custom information, etc.

### 14.2.1 Configure Basic Information

You can add person to the client one by one and configure the person's basic information such as name, gender, email, phone number, etc.

#### Steps

1. Enter **Person** module.

---

#### Note

For the first time you enter **Person** module, a window pops up, and you can set the rules to generate person ID (letters and numbers supported) when adding person. When getting person information from device, if there are no person IDs, the person IDs will be generated according to the rule.

2. Select an organization in the organization list to add the person.

3. Click **Add** to open the adding person window.

The Person ID will be generated automatically.

4. Enter the basic information including person name, gender, telephone number, email address, validity period, etc.

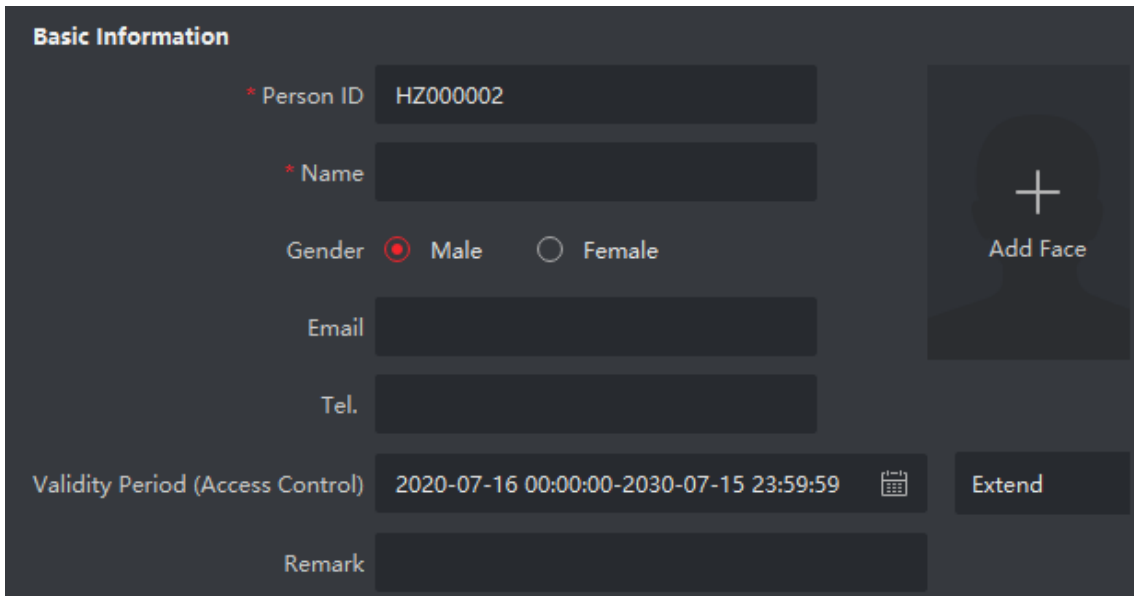

Figure 14-1 Configure Basic Information

---

#### Note

Once validity period expired, the credentials and access control settings of the person will be invalid and the person will have no authorization to access the doors\floors. You can click **Extend** to extend the person's validity period for 1 month, 3 months, 6 months, or 1 year.

5. Confirm to add the person.

- Click **Add** to add the person and close the Add Person window.



- Click **Add and New** to add the person and continue to add other persons.

## 6. Delete Registered Face Picture

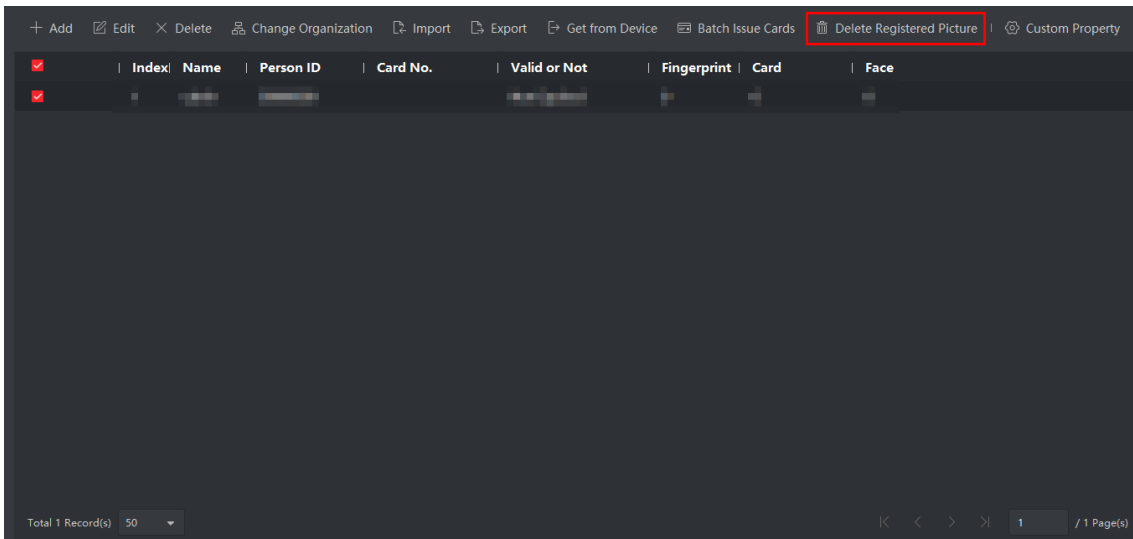

**Figure 14-2 Delete Registered Picture**

### Note

If **Save Pictures in Structure Data Format** is enabled, the **Delete Registered Picture** button will be added to the **Person** page. In general, the registered face picture will be deleted automatically once the person's information is applied to the device. By double clicking the person, the **Edit Person** window will pop up, and you can check whether the registered face picture has been deleted. If not, you can select this person and click **Delete Registered Picture** to delete the picture manually.

---

## 14.2.2 Issue a Card to One Person

When adding a person, you can issue a card to him/her as a credential to access the door(s). Before issuing a card to one person, you need to set the card issuing mode to get the card number. Except for manually entering the card number, the client also provides the other two modes for reading the card number: by local mode (via card enrollment station) or by remote mode (via the card reader of the access control device).

---

### Note

Up to five cards can be issued to one person.

---

## Issue a Card by Entering Card Number

When there is no device (card enrollment station/card reader) available to read card number, you can issue a card by manually entering card number.

### Steps

1. Enter **Person** module.
2. Select an organization in the organization list to add the person and click **Add** to enter Add Person panel.



Enter the person's basic information first. For details about configuring person's basic information, refer to [Configure Basic Information](#) .

---

3. In the **Credential** → **Card** area, click +.

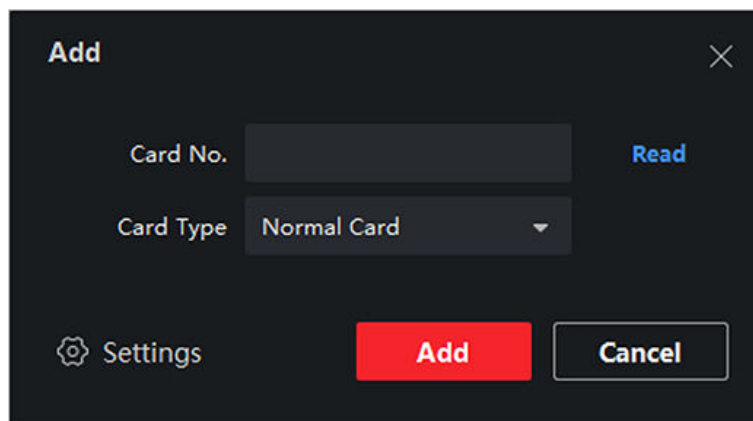

Figure 14-3 Add Card Page

4. Manually enter the card number in the Add page.
5. Click **Add**.

The card will be issued to the person.

## Issue a Card by Local Mode

If a card enrollment station is available, you can issue a card by local mode. To read the card number, you should connect the card enrollment station to the PC running the client by USB interface or COM, and place the card on the card enrollment station.

### Steps

1. Enter **Person** module.
2. Select an organization in the organization list to add the person and click **Add** to enter Add Person panel.

 **Note**

Enter the person's basic information first. For details about configuring person's basic information, refer to [Configure Basic Information](#).

3. In the **Credential** → **Card** area, click +.
4. Click **Settings** to enter the Settings page.
5. Select **Local** as the card issuing mode.

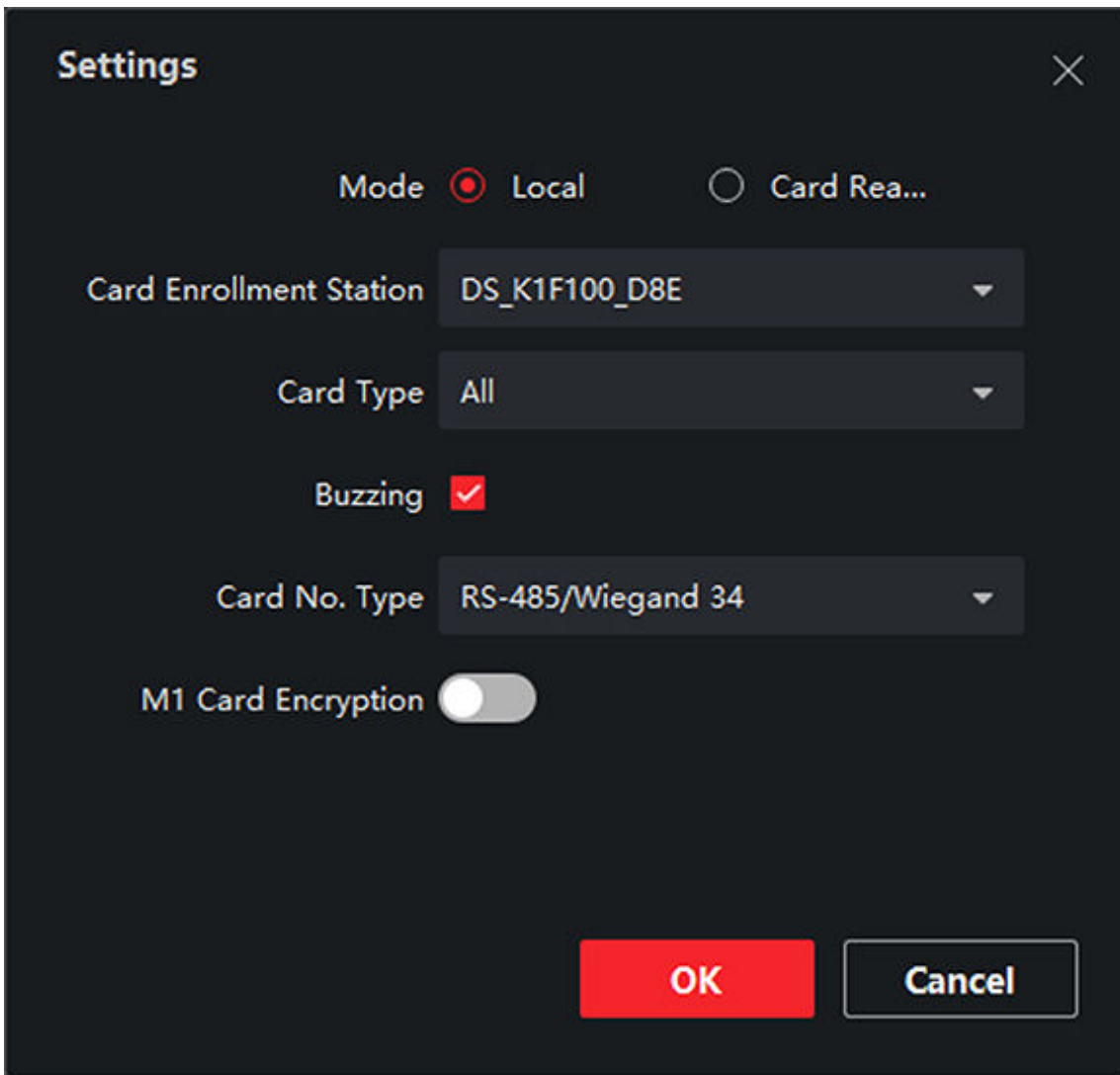

**Figure 14-4 Issue a Card by Local Mode**

6. Set other related parameters.

**Card Enrollment Station**

Select a model of card enrollment station from the drop-down list. You can connect the card enrollment station to the PC, and transfer the basic information about the added person between the two devices through USB.

---

### Note

The currently supported models of card enrollment station: DS-K1F100-D8, DS-K1F100-M, DS-K1F100-D8E, DS-K1F180-D8E, DS-K1F100A-D8E, DS-K1F180A-D8E, and enrollment station.

---

#### **Card Type**

This field is only available when the model is DS-K1F100-D8E or DS-K1F180-D8E. Select the card type as EM card or Mifare card according to the actual card type.

#### **Buzzing**

Enable or disable the buzzing when the card number is read successfully.

#### **Card No. Type**

Select the type of the card number according to actual needs.

#### **M1 Card Encryption**

This field is only available when the model is DS-K1F100-D8, DS-K1F100-D8E, or DS-K1F180-D8E. If the card is M1 card, then you can enable the M1 Card Encryption function and select the sector of the card to encrypt.

7. Click **OK** to confirm the operation.
8. Place the card on the card enrollment station, and click **Read** to get the card number.  
The card number will display in the Card No. field automatically.
9. Click **Add**.  
The card will be issued to the person.

### **Issue a Card by Remote Mode**

Except for issuing a card by local mode, you can also swipe the card on the card reader of the added access control device to get the card number. This is applicable when the client and the persons need issuing cards are not in the same location. For example, you can issue cards for employees in the branch company by remote mode via the client.

#### **Steps**

1. Enter **Person** module.
2. Select an organization in the organization list to add the person and click **Add** to enter Add Person panel.

---

### Note

Enter the person's basic information first. For details about configuring person's basic information, refer to [\*\*\*Configure Basic Information\*\*\*](#).

---

3. In the **Credential → Card** area, click +.
4. Click **Settings** to enter the Settings page.
5. Select **Card Reader** as the card issuing mode.

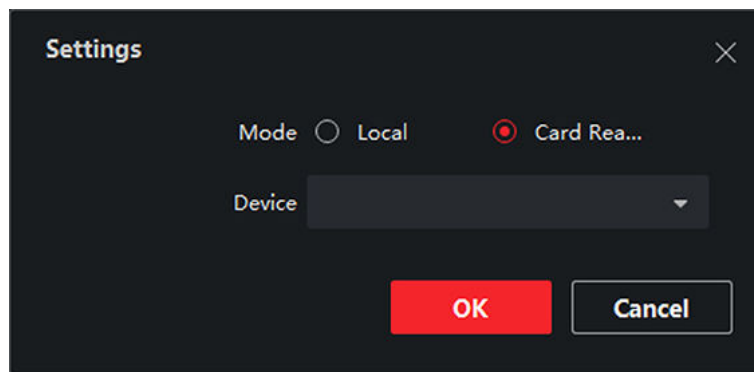

**Figure 14-5 Issue a Card by Remote Mode**

6. Select an access control device added in the client.
7. Select an added access control device or the enrollment station from the drop-down list.

---

 **Note**

- If you select access control device, make sure you have armed the devices.
- If you select the enrollment station, you should click **Login** to set related parameters of the device including IP address, port No., user name, and password. Also, you should check RF card type(s) as needed.

- 
8. Click **OK** to confirm the operation.
  9. Place the card on the card reader, and click **Read** to get the card number.  
The card number will display in the Card No. field automatically.
  10. Click **Add**.  
The card will be issued to the person.

### 14.2.3 Upload a Face Photo from Local PC

When adding person, you can upload a face photo stored in local PC to the client as the person's profile.

#### Steps

1. Enter **Person** module.
2. Select an organization in the organization list to add the person and click **Add**.

---

 **Note**

Enter the person's basic information first. For details about configuring person's basic information, refer to ***Configure Basic Information*** .

- 
3. Click **Add Face** in the Basic Information panel.
  4. Select **Upload**.
  5. Select a picture from the PC running the client.

---

## Note

The picture should be in JPG or JPEG format and smaller than 200 KB.

6. **Optional:** Enable **Verify by Device** to check whether the facial recognition device managed in the client can recognize the face in the photo.

---

## Note

This function is hidden or shown according to the device capacity.

7. Confirm to add the person.
  - Click **Add** to add the person and close the Add Person window.
  - Click **Add and New** to add the person and continue to add other persons .

### 14.2.4 Take a Photo via Client

When adding a person, you can take a photo of a person by the client integrated camera, USB camera or enrollment station, and set this photo as the person's profile.

#### Before You Start

Make sure the PC running the client meets one of the following conditions:

- The client has a camera.
- You have connected USB camera to the PC.
- You have connected enrollment station to the PC by USB interface.

#### Steps

1. Enter **Person** module.
2. Select an organization in the organization list to add the person and click **Add** to enter Add Person window.

---

## Note



Enter the person's basic information first. For details, refer to [\*\*\*Configure Basic Information\*\*\*](#) .

3. Click **Add Face** in the Basic Information area.
4. Select **Take Photo** to enter Take Photo window.
5. Click  to select the integrated camera or enrollment station from the drop-down list.
6. **Optional:** Enable **Verify by Device** to check whether the captured face photo can meet the uploading requirements.

---

## Note

This function is hidden or shown according to the device capacity.

7. Take a photo.
  - 1) Face to the camera and make sure your face is in the middle of the collecting window.
  - 2) Click  to capture a face photo.
  - 3) **Optional:** Click  to capture again.
  - 4) Click **OK** to save the captured photo.

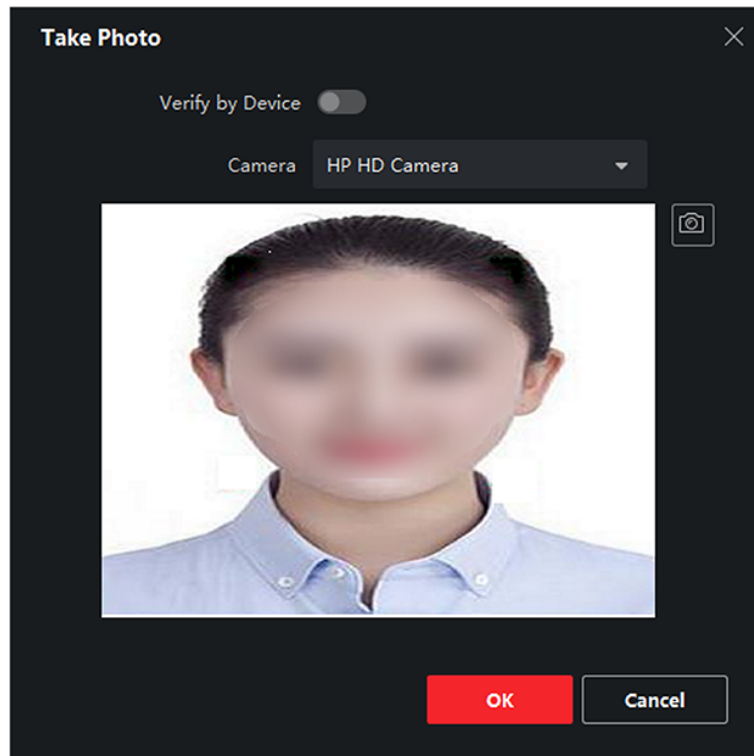

Figure 14-6 Take a Photo via Client

8. Confirm to add the person.
  - Click **Add** to add the person and close the Add Person window.
  - Click **Add and New** to add the person and continue to add other persons.

### 14.2.5 Collect Face via Access Control Device

When adding person, you can collect the person's face via access control device added to the client which supports facial recognition function.

#### Steps

1. Enter **Person** module.
2. Select an organization in the organization list to add the person and click **Add**.

---

#### Note

Enter the person's basic information first. For details about configuring person's basic information, refer to [\*\*\*Configure Basic Information\*\*\*](#) .

---

3. Click **Add Face** in the Basic Information panel.
4. Select **Remote Collection**.
5. Select an added access control device or the enrollment station from the drop-down list.

---

### **Note**

If you select the enrollment station, you should click **Login** to set related parameters of the device including IP address, port No., user name, and password. Also, you can check **Face Anti-Spoofing** and select the liveness level as Low, Medium, or High.

---

### **Face Anti-Spoofing**

If you check this function, then the device can detect whether the face to be collected is an authentic one.

**6. Optional:** Click **Card Reader**, select the card reader ID, click **OK**.

---

### **Note**

This function should be supported by device.

---

**7.** Collect face.

- 1) Face to the camera of the selected access control device and make sure your face is in the middle of the collecting window.
- 2) Click  to capture a photo.
- 3) Click **OK** to save the captured photo.

**8.** Confirm to add the person.

- Click **Add** to add the person and close the Add Person window.
- Click **Add and New** to add the person and continue to add other persons .

## 14.2.6 Collect Fingerprint via Client

Collecting fingerprints locally means you can collect the fingerprint via the fingerprint recorder or the enrollment station connected directly to the PC running the client. The fingerprints recorded can be used as credentials of the persons to access the authorized doors.

### **Before You Start**

Make sure the PC running the client meets one of the following conditions:

- The fingerprint recorder has been connected to the client.
- The enrollment station has been connected to the client.

### **Steps**

- 1.** Enter **Person** module.
  - 2.** Select an organization in the organization list to add the person and click **Add**.
- 

### **Note**

Enter the person's basic information first. For details about configuring person's basic information, refer to [\*\*\*Configure Basic Information\*\*\*](#) .

---

- 3.** In the **Credential → Fingerprint** panel, click +.
  - 4.** In the pop-up window, select the collection mode as **Local**.
  - 5.** Select the model of the connected fingerprint recorder or the enrollment station.
-



---

### **Note**

If the fingerprint recorder is DS-K1F800-F, you can click **Settings** to select the COM the fingerprint recorder connects to.

---

6. Collect the fingerprint.
  - 1) Click **Start**.
  - 2) Place and lift your fingerprint on the fingerprint recorder to collect the fingerprint.
  - 3) Click **Add** to save the recorded fingerprint.
7. Confirm to add the person.
  - Click **Add** to add the person and close the Add Person window.
  - Click **Add and New** to add the person and continue to add other persons.

### 14.2.7 Collect Fingerprint via Access Control Device

When adding person, you can collect fingerprint information via the access control device's fingerprint module. The fingerprints recorded can be used as credentials of the persons to access the authorized doors.

#### **Before You Start**

Make sure fingerprint collection is supported by the access control device.

#### **Steps**

1. Enter **Person** module.
  2. Select an organization in the organization list to add the person and click **Add**.
- 

### **Note**

Enter the person's basic information first. For details about configuring person's basic information, refer to ***Configure Basic Information*** .

---

3. In the **Credential** → **Fingerprint** panel, click +.
  4. In the pop-up window, select the collection mode as **Remote**.
  5. Select an added access control device or the enrollment station from the drop-down list.
- 

### **Note**

If you select the enrollment station, you should click **Login**, and set IP address, port No., user name and password of the device.

---

6. Collect the fingerprint.
    - 1) Click **Start**.
    - 2) Place and lift your fingerprint on the fingerprint scanner of the selected access control device to collect the fingerprint.
    - 3) Click **Add** to save the recorded fingerprint.
  7. Confirm to add the person.
    - Click **Add** to add the person and close the Add Person window.
    - Click **Add and New** to add the person and continue to add other persons .
-

### 14.2.8 Collect Iris via Client

When adding a person, you can collect the iris information by the iris recorder connected to the Client via USB. The iris recorded can be used as credentials of the persons to access the authorized doors.

#### Before You Start

Make sure the iris recorder has been connected to the Client.

#### Steps

1. Enter **Person** module.
2. Select an organization in the organization list to add the person and click **Add**.



Enter the person's basic information first. For details about configuring person's basic information, refer to ***Configure Basic Information*** .

---

3. In the **Credential** → **Iris** panel, click +.
4. In the pop-up window, select the collection mode as **USB**.
5. Collect the iris.
  - 1) Click **Start** to recording the iris.
  - 2) Click **Add** to save the recorded iris.
6. Confirm to add the person.
  - Click **Add** to add the person and close the Add Person window.
  - Click **Add and New** to add the person and continue to add other persons.

### 14.2.9 Collect Iris via Access Control Device

When adding person, you can collect the person's iris information via access control device which supports iris recognition function.

#### Before You Start

Make sure iris collection is supported by the access control device.

#### Steps

1. Enter **Person** module.
2. Select an organization in the organization list and click **Add**.



Enter the person's basic information first. For details about configuring person's basic information, refer to ***Configure Basic Information*** .

---

3. In the **Credential** → **Iris** panel, click +.
4. In the pop-up window, select the collection mode as **Card Reader**.
5. Select an added access control device from the drop-down list.
6. Collect the iris.

- 1) Click **Start** to recording the iris.
- 2) Click **Add** to save the recorded iris.
7. Confirm to add the person.
  - Click **Add** to add the person and close the Add Person window.
  - Click **Add and New** to add the person and continue to add other persons.

## 14.2.10 Configure Access Control Information

When adding a person, you can set her/his access control information, such as binding an access control group with the person, configuring PIN code, setting the person as a visitor, a blocklist person, or a super user, etc.

### Steps

1. Enter **Person** module.
2. Select an organization in the organization list to add the person and click **Add**.
3. In the **Access Control** area, click  to select access group(s) for the person.

---

### Note

For details, refer to [\*\*\*Set Access Group to Assign Access Authorization to Persons\*\*\*](#) .

---

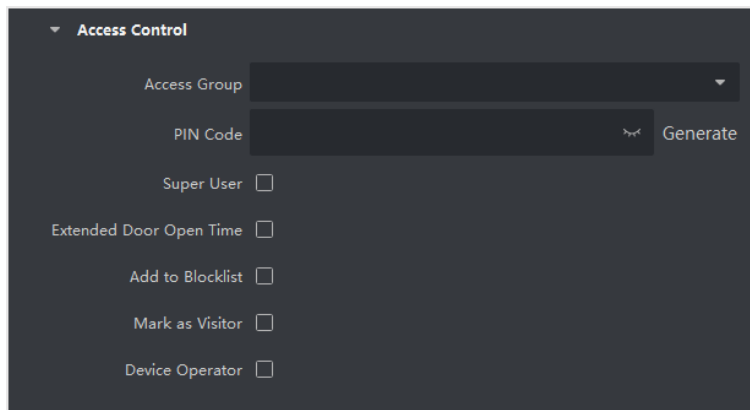

**Figure 14-7 Configure Access Control Information**

4. Set a unique PIN code for the person which can be used for access authentication.
  - Manually enter a PIN code containing 4 to 8 digits.

---

### Note

Persons' PIN codes cannot be repeated.

- Click **Generate** to randomly generate an unrepeated PIN code of 6 digits.

---

### Note

If there are repeated PIN codes, a prompt will pop up on the client. The admin can generate a new PIN code to replace the repeated PIN code and notify related persons.

---

### 5. Check the person's operation permissions.

#### Super User

If the person is set as a super user, he/she will have authorization to access all the doors/floors and will be exempted from remaining closed restrictions, all anti-passback rules, and first person authorization.

#### Extended Door Open Time

Use this function for persons with reduced mobility. When accessing the door, the person will have more time than others to pass through doors.

For details about setting the door's open duration, refer to [\*\*Configure Parameters for Door/Elevator\*\*](#).

#### Add to Blocklist

Add the person to the blocklist and when the person tries to access doors/floors, an event will be triggered and sent to the client to notify the security personnel.

#### Mark as Visitor

If the person is a visitor, you should set the her/his valid times for visit.



#### Note

The valid times for visit is between 1 and 100. You can also check **No Limit**, then there are no limited times for the visitor to access doors/floors.

---

#### Device Operator

For person with device operator role, he/she is authorized to operate on the access control devices.

---



#### Note

The Super User, Extended Door Open Time, Add to Blocklist, and Mark as Visitor functions cannot be enabled concurrently. For example, if one person is set as super user, you cannot enable extended door open time for her/him, add her/him to the blocklist, or set her/him as visitor.

---

### 6. Confirm to add the person.

- Click **Add** to add the person and close the Add Person window.
- Click **Add and New** to add the person and continue to add other persons.

## 14.2.11 Customize Person Information

You can customize the person properties which are not pre-defined in the client according to actual needs, e.g., place of birth. After customizing, when add a person, you can enter the custom information to make the person information complete.

#### Steps

1. Enter **Person** module.

2. Set the fields of custom information.
  - 1) Click **Custom Property**.
  - 2) Click **Add** to add a new property.
  - 3) Enter the property name.
  - 4) Click **OK**.
3. Set the custom information when adding a person.
  - 1) Select an organization in the organization list to add the person and click **Add**.



Enter the person's basic information first. For details about configuring person's basic information, refer to [\*\*\*Configure Basic Information\*\*\*](#) .

- 2) In the **Custom Information** panel, enter the person information.
- 3) Click **Add** to add the person and close the Add Person window, or click **Add and New** to add the person and continue to add other persons.

### 14.2.12 Configure Resident Information

If the person is resident, for video intercom purpose, you need to set the room number for her/him and bind an indoor station. After bound, you can call this person by calling the indoor station and perform video intercom with her/him.

#### Steps

1. Enter **Person** module.
2. Select an organization in the organization list to add the person and click **Add**.



Enter the person's basic information first. For details about configuring person's basic information, refer to [\*\*\*Configure Basic Information\*\*\*](#) .

3. In the **Resident Information** panel, select the indoor station to bind it to the person.



If you select **Analog Indoor Station**, the **Door Station** field will display and you are required to select the door station to communicate with the analog indoor station.

4. Enter the floor No. and room No. of the person.
5. Confirm to add the person.
  - Click **Add** to add the person and close the Add Person window.
  - Click **Add and New** to add the person and continue to add other persons.

### 14.2.13 Configure Additional Information

When adding person, you can configure the additional information for the person, such as person's identity type, identity No., country, etc., according to actual needs.

## Steps

1. Enter **Person** module.
2. Select an organization in the organization list to add the person and click **Add**.

---

### **Note**

Enter the person's basic information first. For details about configuring person's basic information, refer to [\*\*\*Configure Basic Information\*\*\*](#) .

---

3. In the **Additional Information** panel, enter the additional information of the person, including person's ID type, ID No., job title, etc., according to actual needs.
4. Confirm to add the person.
  - Click **Add** to add the person and close the Add Person window.
  - Click **Add and New** to add the person and continue to add other persons .

## 14.3 Import and Export Person Identify Information

You can import the information and pictures of multiple persons to the client software in a batch. Meanwhile, you can also export the person information and pictures and save them in your PC.

### 14.3.1 Import Person Information

You can enter the information of multiple persons in a predefined template (CSV/Excel file) to import the information to the client in a batch.

#### Steps

1. Enter the Person module.
2. Select an added organization in the list, or click **Add** in the upper-left corner to add an organization and then select it.
3. Click **Import** to open the Import panel.
4. Select **Person Information** as the importing mode.
5. Click **Download Template for Importing Person** to download the template.
6. Enter the person information in the downloaded template.

---

### **Note**

- If the person has multiple cards, separate the card No. with semicolon.
  - Items with asterisk are required.
  - By default, the Hire Date is the current date.
- 

7. Click  to select the CSV/Excel file with person information from local PC.
8. Click **Import** to start importing.

---

## Note

- If a person No. already exists in the client's database, delete the existing information before importing.
  - You can import information of no more than 2,000 persons.
- 

### 14.3.2 Import Person Pictures

After importing face pictures for the added persons to the client, the persons in the pictures can be identified by an added face recognition terminal. You can either import person pictures one by one, or import multiple pictures at a time according to your need.

#### Before You Start

Be sure to have imported person information to the client beforehand.

#### Steps

1. Enter the Person module.
  2. Select an added organization in the list, or click **Add** in the upper-left corner to add an organization and then select it.
  3. Click **Import** to open the Import panel and check **Face**.
  4. **Optional:** Enable **Verify by Device** to check whether face recognition device managed in the client can recognize the face in the photo.
  5. Click  to select a face picture file.
- 

## Note

- The (folder of) face pictures should be in ZIP format.
  - Each picture file should be in JPG format and should be no larger than 200 KB.
  - Each picture file should be named as "Person ID\_Name". The Person ID should be the same with that of the imported person information.
- 

6. Click **Import** to start importing.

The importing progress and result will be displayed.

### 14.3.3 Export Person Information

You can export the added persons' information to local PC as a CSV/Excel file.

#### Before You Start

- Make sure you have added persons to an organization.
- Make sure you have enabled the **Export Person Information** function to display the **Export** button. See ***Set General Parameters*** for details.

#### Steps

1. Enter the Person module.
  2. **Optional:** Select an organization in the list.
-

---

### Note

All persons' information will be exported if you do not select any organization.

---

3. Click **Export**.
4. Enter the super user name and password for verification.  
The Export panel is displayed.
5. Check **Person Information** as the content to export.
6. Check desired items to export.
7. Click **Export** to save the exported file in CSV/Excel file on your PC.

### 14.3.4 Export Person Pictures

You can export face picture file of the added persons and save in your PC.

#### Before You Start

- Make sure you have added persons and their face pictures to an organization.
- Make sure you have enabled the **Export Person Information** function to display the **Export** button. See ***Set General Parameters*** for details.

#### Steps

1. Enter the Person module.
  2. **Optional:** Select an organization in the list.
- 

### Note

All persons' face pictures will be exported if you do not select any organization.

---

3. Click **Export** on the top menu bar.
  4. Enter the super user name and password for verification.  
The Export panel is displayed.
  5. Check **Face** as the content to export.
  6. Click **Export** and set an encryption key to encrypt the exported file.
- 

### Note

- The exported file is in ZIP format.
  - The exported face picture is named as "Person ID\_Name\_0" ("0" is for a full-frontal face).
- 

## 14.4 Get Person Information from Access Control Device

If the access control device has been configured with person information (including person details, fingerprint, and issued card information), you can get the person information from the added device and import them to the client for further operations.



### Steps

---

#### Note

- If the person name stored in the device is empty, the person name will be filled with the issued card No. after importing to the client.
  - The gender of the persons will be **Male** by default.
  - If the card number or person ID (employee ID) stored on the device already exists in the client database, the person with this card number or person ID will not be imported to the client.
- 

1. Enter **Person** module.
  2. Select an organization to import the persons.
  3. Click **Get from Device**.
  4. Select an added access control device or the enrollment station from the drop-down list.
- 

#### Note

If you select the enrollment station, you should click **Login**, and enter IP address, port No., user name and password of the device.

---

5. Select the **Getting Mode**.
- 

#### Note

The getting mode varies according to different devices. The access control device supports getting the person information by employee ID. Up to 5 employee IDs can be specified each time.

---

6. Click **Import** to start importing the person information to the client.
- 

#### Note

Up to 2,000 persons and 5,000 cards can be imported.

---

The person information, including person details, person's fingerprint information (if configured), and the linked cards (if configured), will be imported to the selected organization.

---

## 14.5 Move Persons to Another Organization

You can move the added persons to another organization if you need.

### Before You Start

- Make sure you have added at least two organizations.
- Make sure you have imported person information.

### Steps

1. Enter **Person** module.
  2. Select an organization in the left panel.  
The persons under the organization will be displayed in the right panel.
  3. Select the person to move.
-

4. Click **Change Organization**.
5. Select the organization to move persons to.
6. Click **OK**.

## 14.6 Issue Cards to Persons in Batch

The client provides a convenient way to issue cards to multiple persons in a batch.



### Steps

1. Enter **Person** module.
2. Click **Batch Issue Cards**.  
All the added persons with no card issued will be displayed in the right panel.
3. **Optional:** Enter key words (name or person ID) in the input box to filter the person(s) that need issuing cards.
4. **Optional:** Click **Settings** to set the card issuing parameters. For details, refer to [\*\*\*Issue a Card to One Person\*\*\*](#).
5. Click **Initialize** to initialize the card enrollment station or card reader to make it ready for issuing cards.
6. Click the **Card No.** column and enter the card number.
  - Place the card on the card enrollment station.
  - Swipe the card on the card reader.
  - Manually enter the card number and press the **Enter** key.The person(s) in the list will be issued with card(s).

## 14.7 Report Card Loss

If the person lost his/her card, you can report the card loss so that the card's related access authorization will be inactive.

### Steps

1. Enter **Person** module.
2. Select the person you want to report card loss for and click **Edit** to open the Edit Person window.
3. In the **Credential → Card** panel, click  on the added card to set this card as lost card.  
After reporting card loss, the access authorization of this card will be invalid and inactive. Other person who gets this card cannot access the doors by swiping this lost card.
4. **Optional:** If the lost card is found, you can click  to cancel the loss.  
After cancelling card loss, the access authorization of the person will be valid and active.
5. If the lost card is added in one access group and the access group is applied to the device already, after reporting card loss or cancelling card loss, a window will pop up to notify you to apply the changes to the device. After applying to device, these changes can take effect on the device.

## **14.8 Object Missing**

This object is not available in the repository.

## Chapter 15 Access Control

The Access Control module is applicable to access control devices and video intercom device. It provides multiple functionalities, including access group configuration, video intercom, and other advanced functions.

 **Note**

For the user with access control module permissions, the user can enter the Access Control module and configure the access control settings. For setting the user permission of Access Control module, refer to [\*\*Add User\*\*](#).

### 15.1 Flow Chart

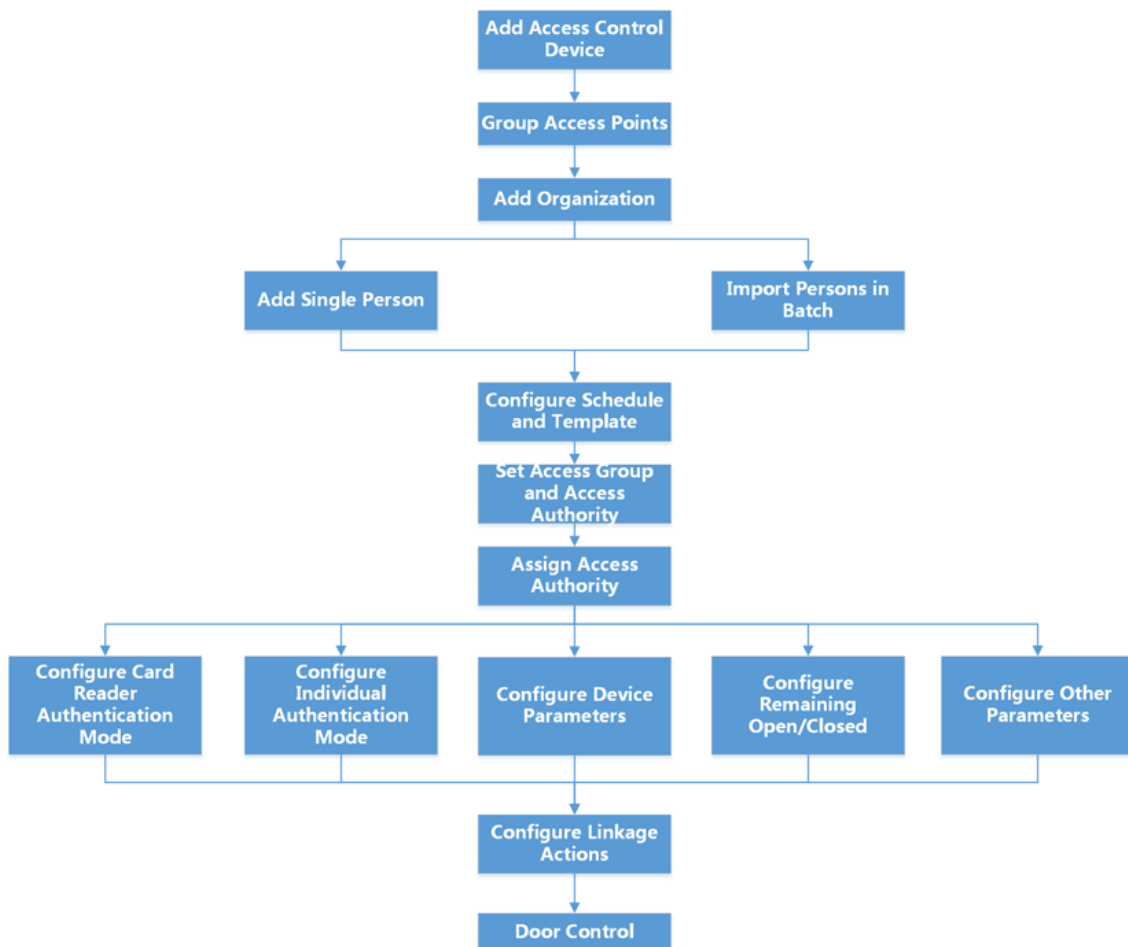

Figure 15-1 Flow Chart of Access Control

- **Add Access Control Device:** You can add access control devices on the client. For more details, refer to [\*\*\*Add Device\*\*\*](#) .
- **Group Access Points:** You can group the added access points into groups for convenient management. For more details, refer to [\*\*\*Group Management\*\*\*](#) .
- **Add Organization:** You can add an organization and import person information to the organization for managing persons. For more details, refer to [\*\*\*Add Organization\*\*\*](#) .
- **Configure Schedule and Template:** You can configure the template including holiday and week schedule. For more details, refer to [\*\*\*Configure Schedule and Template\*\*\*](#) .
- **Set Access Group and Access Authority:** You can set an access group to define which person(s) can get access to which door(s) and then apply the access group to the access control device to take effect. For more details, refer to [\*\*\*Set Access Group to Assign Access Authorization to Persons\*\*\*](#) .
- **Configure Device Parameters:** You can configure parameters for the access control device, including device time, linkage settings, maintenance settings, etc. For more details, refer to [\*\*\*Configure Device Parameters\*\*\*](#) .
- **Configure Remaining Open/Closed:** You can set the status of the door as open or closed and set the elevator controller as free and controlled. For more details, refer to [\*\*\*Configure Remaining Unlocked/Locked\*\*\*](#) .
- **Configure Card Reader Authentication Mode:** You can set the passing rules for the card reader of the access control device according to your actual needs. For more details, refer to [\*\*\*Configure Card Reader Authentication Mode and Schedule\*\*\*](#) .
- **Configure Individual Authentication Mode:** You can set the passing rules for person to the specified the access control device according to your actual needs. For more details, refer to [\*\*\*Configure Person Authentication Mode\*\*\*](#) .
- **Configure Other Parameters:** You can set parameters for access control devices such as network parameters, capture parameters, RS-485 parameters, Wiegand parameters, etc. For more details, refer to [\*\*\*Configure Other Parameters\*\*\*](#) .
- **Configure Linkage Actions:** You can configure linkage action for access control, so that the events can trigger a series of linkage actions to notify the security personnel. For more details, refer to [\*\*\*Configure Linkage Actions for Access Control\*\*\*](#) .
- **Door/Elevator Control:** You can view the real-time status of the doors or elevators managed by the added access control device. For more details, refer to [\*\*\*Door/Elevator Control\*\*\*](#) .

## 15.2 Configure Schedule and Template

You can configure the template including holiday and week schedule. After setting the template, you can adopt the configured template to access groups when setting the access groups, so that the access group will take effect in the time durations of the template.



For access group settings, refer to [\*\*\*Set Access Group to Assign Access Authorization to Persons\*\*\*](#) .

---

## 15.2.1 Add Holiday

You can create holidays and set the days in the holidays, including start date, end date, and holiday duration in one day.

### Steps

---

#### Note

You can add up to 64 holidays in the software system.

---

1. Click **Access Control** → **Schedule** → **Holiday** to enter the Holiday page.
  2. Click **Add** on the left panel.
  3. Create a name for the holiday.
  4. **Optional:** Enter the descriptions or some notifications of this holiday in the Remark box.
  5. Add a holiday period to the holiday list and configure the holiday duration.
- 

#### Note

Up to 16 holiday periods can be added to one holiday.





---

- 1) Click **Add** in the Holiday List field.
  - 2) Drag the cursor to draw the time duration, which means in that duration of time, the configured access group is activated.
- 

#### Note

Up to 8 time durations can be set to one holiday period.

---

- 3) **Optional:** Perform the following operations to edit the time durations.
    - Move the cursor to the time duration and drag the time duration on the timeline bar to the desired position when the cursor turns to .
    - Click the time duration and directly edit the start/end time in the appeared dialog.
    - Move the cursor to the start or the end of time duration and drag to lengthen or shorten the time duration when the cursor turns to .
  - 4) **Optional:** Select the time duration(s) that need to be deleted, and then click  in the Operation column to delete the selected time duration(s).
  - 5) **Optional:** Click  in the Operation column to clear all the time duration(s) in the time bar.
  - 6) **Optional:** Click  in the Operation column to delete this added holiday period from the holiday list.
6. Click **Save**.

## 15.2.2 Add Template

Template includes week schedule and holiday. You can set week schedule and assign the time duration of access authorization for different person or group. You can also select the added holiday(s) for the template.

## Steps

---

### Note

You can add up to 255 templates in the software system.

---

1. Click **Access Control** → **Schedule** → **Template** to enter the Template page.
- 

### Note

There are two default templates: All-Day Authorized and All-Day Denied, and they cannot be edited or deleted.

#### **All-Day Authorized**

The access authorization is valid in each day of the week and it has no holiday.

#### **All-Day Denied**

The access authorization is invalid in each day of the week and it has no holiday.



---

2. Click **Add** on the left panel to create a new template.
  3. Create a name for the template.
  4. Enter the descriptions or some notification of this template in the Remark box.
  5. Edit the week schedule to apply it to the template.
    - 1) Click **Week Schedule** tab on the lower panel.
    - 2) Select a day of the week and draw time duration(s) on the timeline bar.
- 

### Note

Up to 8 time duration(s) can be set for each day in the week schedule.

---

- 3) **Optional:** Perform the following operations to edit the time durations.
    - Move the cursor to the time duration and drag the time duration on the timeline bar to the desired position when the cursor turns to .
    - Click the time duration and directly edit the start/end time in the appeared dialog.
    - Move the cursor to the start or the end of time duration and drag to lengthen or shorten the time duration when the cursor turns to .
  - 4) Repeat the two steps above to draw more time durations on the other days of the week.
6. Add a holiday to apply it to the template.
- 

### Note

Up to 4 holidays can be added to one template.

---

- 1) Click **Holiday** tab.
  - 2) Select a holiday in the left list and it will be added to the selected list on the right panel.
  - 3) **Optional:** Click **Add** to add a new holiday.
- 

### Note

For details about adding a holiday, refer to ***Add Holiday*** .

---

- 4) **Optional:** Select a selected holiday in the right list and click  to remove the selected one, or click **Clear** to clear all the selected holiday(s) in the right list.
7. Click **Save** to save the settings and finish adding the template.

### 15.3 Set Access Group to Assign Access Authorization to Persons

After adding the person and configuring the person's credentials, you can create the access groups to define which person(s) can get access to which door(s) and then apply the access group to the access control device to take effect.

#### Before You Start

- Add person to the client.
- Add access control device to the client and group access points. For details, refer to ***Group Management***.
- Add template.

#### Steps

When the access group settings are changed, you need to apply the access groups to the devices again to take effect. The access group changes include changes of template, access group settings, person's access group settings, and related person details (including card number, fingerprint, face picture, linkage between card number and fingerprint, linkage between card number and fingerprint, card password, card effective period, etc).

1. Click **Access Control → Authorization → Access Group** to enter the Access Group interface.
2. Click **Add** to open the Add window.
3. In the **Name** text field, create a name for the access group as you want.
4. Select a template for the access group.



#### Note

You should configure the template before access group settings. Refer to ***Configure Schedule and Template*** for details.

- 
5. In the left list of the Select Person field, select person(s) to assign access authority.
  6. In the left list of the Select Access Point field, select door(s), door station(s) or floor(s) for the selected persons to access.
  7. Click **Save**.

You can view the selected person(s) and the selected access point(s) on the right side of the interface.



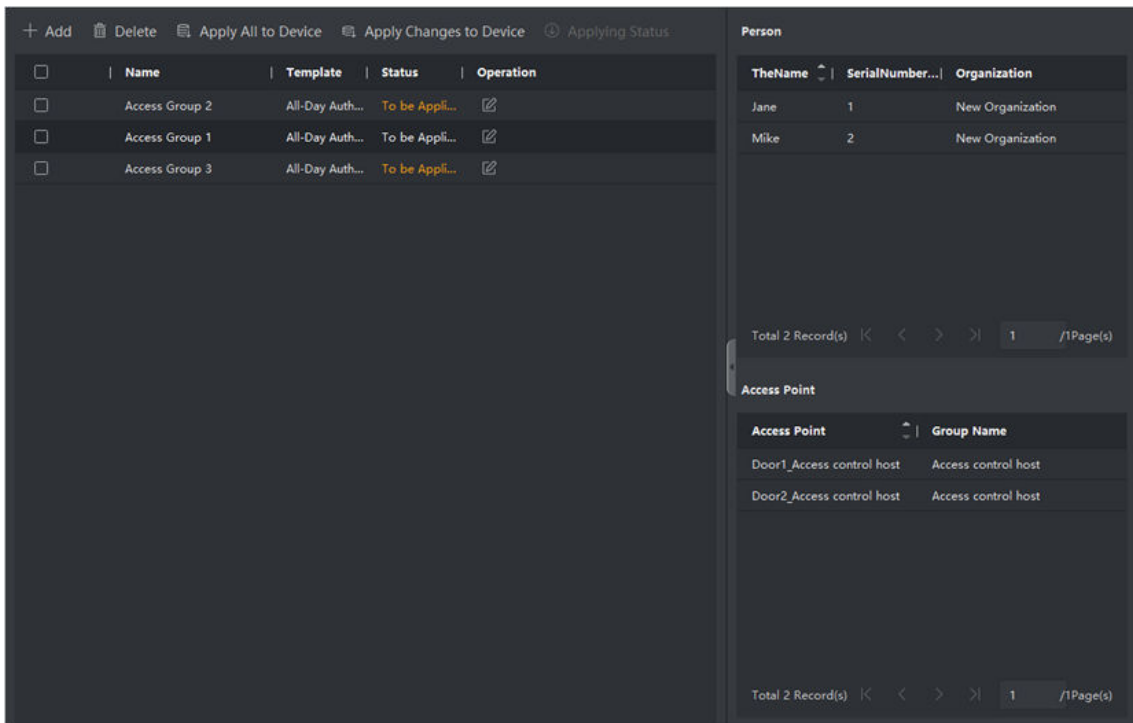

**Figure 15-2 Display the Selected Person(s) and Access Point(s)**

8. After adding the access groups, you need to apply them to the access control device to take effect.
  - 1) Select the access group(s) to apply to the access control device.
  - 2) Click **Apply All to Devices** start applying all the selected access group(s) to the access control device or door station.
  - 3) Click **Apply All to Devices** or **Apply Changes to Devices**.

**Apply All to Devices**

This operation will clear all the existed access groups of the selected devices and then apply the new access group to the device.

**Apply Changes to Devices**

This operation will not clear the existed access groups of the selected devices and only apply the changed part of the selected access group(s) to the device(s).

- 4) View the applying status in the Status column or click **Applying Status** to view all the applied access group(s).

 **Note**

You can check **Display Failure Only** to filter the applying results.

The selected persons in the applied access groups will have the authorization to enter/exit the selected doors/door stations with their linked card(s) or fingerprints.

9. **Optional:** Click  to edit the access group if necessary.

## Note

If you change the persons' access information or other related information, you will view the prompt **Access Group to Be Applied** on the right corner of the client. You can click the prompt to apply the changed data to the device. You can select either **Apply Now** or **Apply Later**.

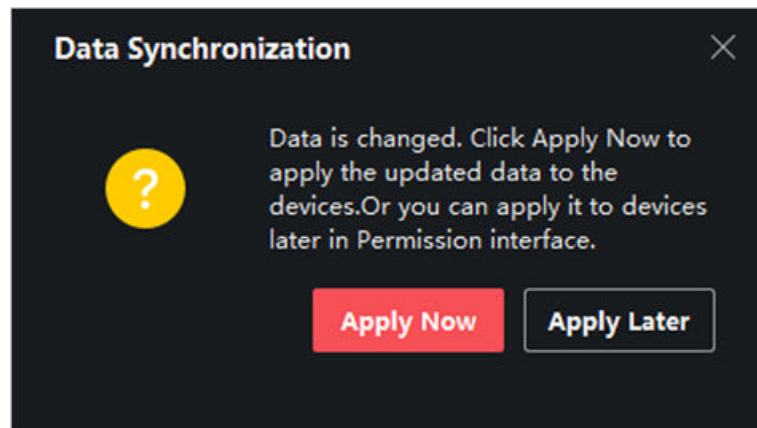

Figure 15-3 Data Synchronization

---

## 15.4 Search Access Group

After setting access group and assigning access authority to persons, you can search the access group that the person belongs to and view other related information including credential No., credential type, applying status, etc.

## Note

Make sure you have set access group to assign access authorization to designed persons and applied it. For details, refer to ***Set Access Group to Assign Access Authorization to Persons***.

Click **Access Control** → **Authorization** → **Search**. Select a device name, and set search condition (including person name and applying status, optional), and then click **Search**.

You can view the access group that the searched person belongs to and other information including the credential type, door name, credential No., applying status, remark, etc.

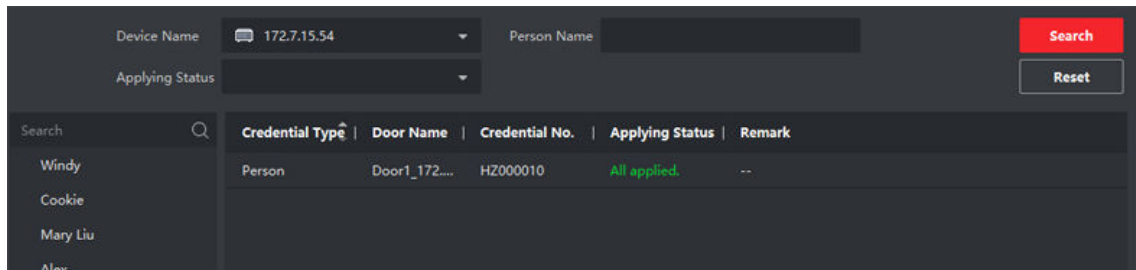



Figure 15-4 Search Access Group

## 15.5 Configure Advanced Functions

You can configure the advanced functions of access control to meet some special requirements in different scene, such as multi-factor authentication, anti-passback, etc.

### Note

- For the card related functions(the type of access control card/multi-factor authentication), only the card(s) with access group applied will be listed when adding cards.
- The advanced functions should be supported by the device.
- Hover the cursor on the Advanced Function, and then Click  to customize the advanced function(s) to be displayed.

### 15.5.1 Configure Device Parameters

After adding the access control device, you can configure the parameters of access control device (access controller), access control points (door or floor), alarm inputs, alarm outputs, card readers and lane controller.

#### Configure Parameters for Access Control Device

After adding the access control device, you can configure its parameters, including overlaying user information on picture, uploading pictures after capturing, saving captured pictures, etc.

#### Before You Start

Add access control device to the client.

#### Steps

1. Click **Access Control** → **Advanced Function** → **Device Parameter** .

---

## **Note**

If you can not find Device Parameter in the Advanced Function list, hover the cursor on the Advanced Function, and then Click  to select the Device Parameter to be displayed.

2. Select an access device to show its parameters on the right page.
3. Turn the switch to ON to enable the corresponding functions.

---

## **Note**

- The displayed parameters may vary for different access control devices.
- Some of the following parameters are not listed in the Basic Information page, click **More** to edit the parameters.

---

### **RS-485 Comm. Redundancy**

You should enable this function if you wire the RS-485 card reader to the access control device redundantly.

### **Display Detected Face**

Display face picture when authenticating.

### **Display Card Number**

Display the card information when authenticating.

### **Display Person Information**

Display the person information when authenticating.

### **Overlay Person Info. on Picture**

Display the person information on the captured picture.

### **Voice Prompt**

If you enable this function, the voice prompt is enabled in the device. You can hear the voice prompt when operating in the device.

### **Upload Pic. After Linked Capture**

Upload the pictures captured by linked camera to the system automatically.

### **Save Pic. After Linked Capture**

If you enable this function, you can save the picture captured by linked camera to the device.

### **Press Key to Enter Card Number**

If you enable this function, you can input the card No. by pressing the key.

### **Wi-Fi Probe**

If you enable this function, the device can probe the surrounding communication devices' MAC address and upload the MAC address to the system. If the MAC address match the specified MAC address, the system can trigger some linkage actions.

### **3G/4G**

If you enable this function, the device can communicate in 3G/4G network.

### NFC Anti-Cloning

If you enable this function, you cannot use the cloned card for authentication and further enhance security.

4. Click **OK**.

5. **Optional:** Click **Copy to**, and then select the access control device(s) to copy the parameters in the page to the selected device(s).

### Configure Parameters for Door/Elevator

After adding the access control device, you can configure its access point (door or floor) parameters.

#### Before You Start

Add access control device to the client.

#### Steps

1. Click **Access Control** → **Advanced Function** → **Device Parameter** .

2. Select an access control device on the left panel, and then click  to show the doors or floors of the selected device.

3. Select a door or floor to show its parameters on the right page.

4. Edit the door or floor parameters.



#### Note

- The displayed parameters may vary for different access control devices.
  - Some of the following parameters are not listed in the Basic Information page, click **More** to edit the parameters.
- 

#### Name

Edit the card reader name as desired.

#### Door Contact

You can set the door sensor as remaining closed or remaining open. Usually, it is remaining closed.

#### Exit Button Type

You can set the exit button as remaining closed or remaining open. Usually, it is remaining open.

#### Door Locked Time

After swiping the normal card and relay action, the timer for locking the door starts working.

#### Extended Open Duration

The door contact can be enabled with appropriate delay after person with extended access needs swipes her/his card.

#### Door Left Open Timeout Alarm

The alarm can be triggered if the door has not been closed in a configured time period. If it is set as 0, no alarm will be triggered.

### Lock Door when Door Closed

The door can be locked once it is closed even if the **Door Locked Time** is not reached.

### Duress Code

The door can open by inputting the duress code when there is duress. At the same time, the client can report the duress event.

### Super Password

The specific person can open the door by inputting the super password.

### Dismiss Code

Create a dismiss code which can be used to stop the buzzer of the card reader (by entering the dismiss code on the keypad).



### Note

- The duress code, super code, and dismiss code should be different.
- The duress code, super password, and the dismiss code should be different from the authentication password.
- The length of duress code, super password, and the dismiss code is according the device, usually it should contains 4 to 8 digits.

---

5. Click **OK**.

6. **Optional:** Click **Copy to** , and then select the door/floor(s) to copy the parameters in the page to the selected doors/floor(s).



### Note

The door or floor's status duration settings will be copied to the selected door/floor(s) as well.

---

## Configure Parameters for Card Reader

After adding the access control device, you can configure its card reader parameters.

### Before You Start

Add access control device to the client.

### Steps

1. Click **Access Control** → **Advanced Function** → **Device Parameter** .
2. In the device list on the left, click  to expand the door, select a card reader and you can edit the card reader's parameters on the right.
3. Edit the card reader basic parameters in the Basic Information page.

---

### **Note**

- The displayed parameters may vary for different access control devices. There are part of parameters listed as follows. Refer to the user manual of the device for more details.
  - Some of the following parameters are not listed in the Basic Information page, click **More** to edit the parameters.
- 

#### **Name**

Edit the card reader name as desired.

#### **OK LED Polarity/Error LED Polarity/Buzzer Polarity**

Set OK LED Polarity/Error LED Polarity/Buzzer LED Polarity of main board according to the card reader parameters. Generally, adopts the default settings.

#### **Minimum Card Swiping Interval**

If the interval between card swiping of the same card is less than the set value, the card swiping is invalid. You can set it as 0 to 255.

#### **Max. Interval When Entering PWD**

When you inputting the password on the card reader, if the interval between pressing two digits is larger than the set value, the digits you pressed before will be cleared automatically.

#### **Alarm of Max. Failed Attempts**

Enable to report alarm when the card reading attempts reach the set value.

#### **Max. Times of Card Failure**

Set the max. failure attempts of reading card.

#### **Tampering Detection**

Enable the anti-tamper detection for the card reader.

#### **Communicate with Controller Every**

When the access control device cannot connect with the card reader for longer than the set time, the card reader will turn offline automatically.

#### **Buzzing Time**

Set the card reader buzzing time. The available time ranges from 0 to 5,999s. 0 represents continuous buzzing.

#### **Card Reader Type/Card Reader Description**

Get card reader type and description. They are read-only.

#### **Fingerprint Recognition Level**

Select the fingerprint recognition level in the drop-down list.

#### **Default Card Reader Authentication Mode**

View the default card reader authentication mode.

#### **Fingerprint Capacity**

View the maximum number of available fingerprints.

### **Existing Fingerprint Number**

View the number of existed fingerprints in the device.

### **Score**

The device will score the captured picture according to the yaw angle, pitch angle, and pupillary distance. If the score is less than the configured value, face recognition will be failed.

### **Face Recognition Timeout Value**

If the recognition time is more than the configured time, the device will remind you.

### **Face Recognition Interval**

The time interval between two continuous face recognitions when authenticating. By default, it is 2s.

### **Face 1:1 Matching Threshold**

Set the matching threshold when authenticating via 1:1 matching mode. The larger the value, the smaller the false accept rate and the larger the false rejection rate when authentication.

### **1:N Security Level**

Set the matching security level when authenticating via 1:N matching mode. The larger the value, the smaller the false accept rate and the larger the false rejection rate when authentication.

### **Live Face Detection**

Enable or disable the live face detection function. If enabling the function, the device can recognize whether the person is a live one or not.

### **Live Face Detection Security Level**

After enabling Live Face Detection function, you can set the matching security level when performing live face authentication.

### **Max. Failed Attempts for Face Auth.**

Set the maximum live face detection failed attempts. The system will lock the user's face for 5 minutes if the live face detection is failed for more than the configured attempts. The same user cannot authenticate via the fake face within 5 minutes. Within the 5 minutes, the user can authenticate via the real face twice continuously to unlock.

### **Lock Authentication Failed Face**

After enabling the Live Face Detection function, the system will lock the user's face for 5 minutes if the live face detection is failed for more than the configured attempts. The same user cannot authenticate via the fake face within 5 minutes. Within the 5 minutes, the user can authenticate via the real face twice continuously to unlock.

### **Application Mode**

You can select indoor or others application modes according to actual environment.

4. Click **OK**.



- 5. Optional:** Click **Copy to**, and then select the card reader(s) to copy the parameters in the page to the selected card reader(s).

### Configure Parameters for Alarm Input

After adding the access control device, you can configure the parameters for its alarm inputs.

#### Before You Start

Add access control device to the client, and make sure the device supports alarm input.

#### Steps

---



#### Note

If the alarm input is armed, you cannot edit its parameters. Disarm it first.

---

1. Click **Access Control** → **Advanced Function** → **Device Parameter** .
2. In the device list on the left, click  to expand the door, select an alarm input and you can edit the alarm input's parameters on the right.
3. Set the alarm input parameters.

#### Name

Edit the alarm input name as desired.

#### Detector Type

The detector type of the alarm input.

#### Zone Type

Set the zone type for the alarm input.

#### Sensitivity

Only when the duration of signal detected by the detector reaches the setting time, the alarm input is triggered. For example, you have set the sensitivity as 10ms, only when the duration of signal detected by the detector reach 10ms, this alarm input is triggered.

#### Trigger Alarm Output

Select the alarm output(s) to be triggered.

4. Click **OK**.
- 5. Optional:** Click the switch on the upper-right corner to arm or disarm the alarm input.

### Configure Parameters for Alarm Output

After adding the access control device, if the device links to alarm outputs, you can configure the parameters.

#### Before You Start

Add access control device to the client, and make sure the device supports alarm output.

### Steps

1. Click **Access Control** → **Advanced Function** → **Device Parameter** to enter access control parameter configuration page.
2. In the device list on the left, click  to expand the door, select an alarm input and you can edit the alarm input's parameters on the right.
3. Set the alarm output parameters.

#### **Name**

Edit the card reader name as desired.

#### **Alarm Output Active Time**

How long the alarm output will last after triggered.

4. Click **OK**.
5. **Optional:** Set the switch on the upper right corner to **ON** to trigger the alarm output.

## Configure Parameters for Lane Controller

After adding the lane controller to the client, you can configure its parameters for passing through the lane.

### Before You Start

Add access control device to the client.

### Steps

1. Click **Access Control** → **Advanced Function** → **Device Parameter** to enter Parameter Settings page.
2. In the device list on the left, select a lane controller and you can edit the lane controller's parameters on the right.
3. Edit the parameters.

#### **Passing Mode**

Select the controller which will control the barrier status of the device.

- If you select **According to Lane Controller's DIP Settings**, the device will follow the lane controller's DIP settings to control the barrier. The settings on the software will be invalid.
- If you select **According to Main Controller's Settings**, the device will follow the settings of the software to control the barrier. The DIP settings of the lane controller will be invalid.

#### **Free Passing Authentication**

If you enable this function, when both entrance and exit's barrier mode is Remain Open, the pedestrians should authenticate each time passing through the lane. Or an alarm will be triggered.

#### **Opening/Closing Barrier Speed**

Set the barrier's opening and closing speed. You can select from 1 to 10. The greater the value, the faster the speed.

---

 **Note**

The recommended value is 6.

---

### **Audible Prompt Duration**

Set how long the audio will last, which is played when an alarm is triggered .

---

 **Note**

0 refers to the alarm audio will be played until the alarm is ended.

---

### **Temperature Unit**

Select the temperature unit that displayed in the device status.

4. Click **OK**.

## **15.5.2 Configure Remaining Unlocked/Locked**

You can set the status of the door as unlocked or locked and set the elevator controller as free and controlled. For example, you can set the door remaining locked in the holiday, and set the door remaining unlocked in the specified period of the work day.

### **Before You Start**

Add the access control devices to the system.

### **Steps**

1. Click **Access Control** → **Advanced Function** → **Remain Locked/Unlocked** to enter the Remain Locked/Unlocked page.
  2. Select the door or elevator controller that need to be configured on the left panel.
  3. To set the door or elevator controller status during the work day, click the **Week Schedule** and perform the following operations.
    - 1) For door, click **Remain Unlocked**, **Remain Locked**, **Inductive Mode**, or **Barrier-Free Mode**.
- 

 **Note**

- **Inductive Mode:** The door opening and closing is triggered by infrared induction of human body.
  - **Barrier-Free Mode:** When a large number of people need to pass the door, the door will remain open (without frequent authentication) if the person and ID comparison succeeds. Only when the person and ID comparison fails, the door will be closed.
  - Inductive mode and barrier-free mode should be supported by device.
- 



- 2) For elevator controller, click **Free** or **Controlled**.
  - 3) Drag the cursor to draw the time duration, which means in that duration of time, the configured access group is activated.
- 

 **Note**

Up to 8 time durations can be set to each day in the week schedule.

---

4) **Optional:** Perform the following operations to edit the time durations.

- Move the cursor to the time duration and drag the time duration on the timeline bar to the desired position when the cursor turns to .
- Click the time duration and directly edit the start/end time in the appeared dialog.
- Move the cursor to the start or the end of time duration and drag to lengthen or shorten the time duration when the cursor turns to .

5) Click **Save**.

### Related Operations

**Copy to Whole Week** Select one duration on the time bar, click **Copy to Whole Week** to copy all the duration settings on this time bar to other week days.

**Delete Selected** Select one duration on the time bar, click **Delete Selected** to delete this duration.

**Clear** Click **Clear** to clear all the duration settings in the week schedule.

4. To set the door status during the holiday, click the **Holiday** and perform the following operations.

1) Click **Remain Unlocked**, **Remain Locked**, **Inductive Mode**, or **Barrier-Free Mode**.

2) Click **Add**.

3) Enter the start date and end date.

4) Drag the cursor to draw the time duration, which means in that duration of time, the configured access group is activated.





### Note

Up to 8 time durations can be set to one holiday period.

---

5) Perform the following operations to edit the time durations.

- Move the cursor to the time duration and drag the time duration on the timeline bar to the desired position when the cursor turns to .
- Click the time duration and directly edit the start/end time in the appeared dialog.
- Move the cursor to the start or the end of time duration and drag to lengthen or shorten the time duration when the cursor turns to .

6) **Optional:** Select the time duration(s) that need to be deleted, and then click  in the Operation column to delete the selected time duration(s).

7) **Optional:** Click  in the Operation column to clear all the time duration(s) in the time bar.

8) **Optional:** Click  in the Operation column to delete this added holiday period from the holiday list.

9) Click **Save**.

5. **Optional:** Click **Copy to** to copy the door status settings of this door to other door(s).

### 15.5.3 Configure Multi-Factor Authentication

You can manage the persons by group and set the authentication for multiple persons of one access control point (door).

## Before You Start

Set access group and apply the access group to the access control device. For details, refer to **Set Access Group to Assign Access Authorization to Persons** .

Perform this task when you want to set authentications for multiple cards of one access control point (door).

## Steps

1. Click **Access Control → Advanced Function → Multi-Factor Auth** .
2. Select an access control device in device list on the left panel.
3. Add a person/card group for the access control device.
  - 1) Click **Add** on the right panel.
  - 2) Create a name for the group as desired.
  - 3) Specify the start time and end time of the effective period for the person/card group.
  - 4) Select members(s) and card(s) in the Available list, and the selected member(s) and card(s) will be added to the Selected list.

---

### Note

Make sure you have issue card to the person.

Make sure you have set access group and apply the access group to the access control device successfully.

- 
- 5) Click **Save**.
  - 6) **Optional:** Select the person/card group(s), and then click **Delete** to delete it(them).
  - 7) **Optional:** Select the person/card group(s), and then click **Apply** to re-apply access group that failed to be applied previously to the access control device.
  4. Select an access control point (door) of selected device on the left panel.
  5. Enter the maximum interval when entering password.
  6. Add an authentication group for the selected access control point.
    - 1) Click **Add** on the Authentication Groups panel.
    - 2) Select a configured template as the authentication template from the drop-down list.

---

### Note

For setting the template, refer to **Configure Schedule and Template** .

- 
- 3) Select the authentication type as **Local Authentication, Local Authentication and Remotely Open Door, or Local Authentication and Super Password** from the drop-down list.

#### **Local Authentication**

Authentication by the access control device.

#### **Local Authentication and Remotely Open Door**

Authentication by the access control device and by the client. When the person swipes the card on the device, a window will pop up. You can unlock the door via the client.

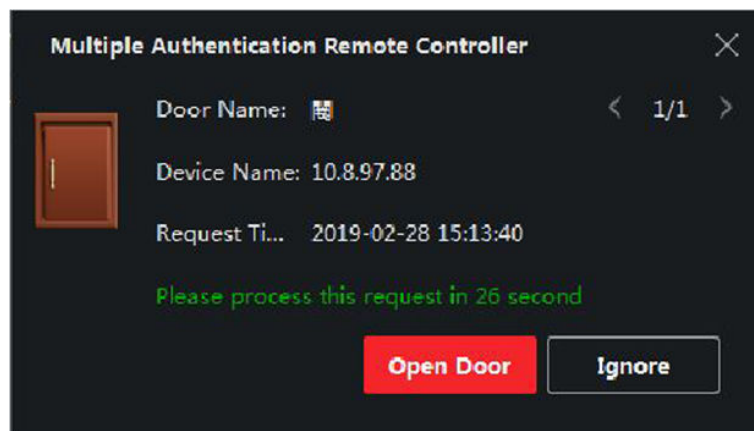

Figure 15-5 Remotely Open Door

---

 **Note**

You can check **Offline Authentication** to enable the super password authentication when the access control device is disconnected with the client.

---

### Local Authentication and Super Password

Authentication by the access control device and by the super password.

- 4) Select the added person/card group in the left list below and it will be added to the Selected list on the right as the authentication group.
  - 5) Click the added authentication group in the right list to set authentication times in the Auth Times column.
- 

 **Note**

- The authentication times should be larger than 0 and smaller than the added personnel quantity in the personnel group.
  - The maximum value of authentication times is 16.
- 

- 6) Click **Save**.
- 

 **Note**

- For each access control point (door), up to four authentication groups can be added.
  - For the authentication group of which authentication type is **Local Authentication**, up to 8 person/card groups can be added to the authentication group.
  - For the authentication group of which authentication type is **Local Authentication and Super Password** or **Local Authentication and Remotely Open Door**, up to 7 person/card groups can be added to the authentication group.
- 

7. Click **Save**.
-

## 15.5.4 Configure Custom Wiegand Rule

Based on the knowledge of uploading rule for the third party Wiegand, you can set multiple customized Wiegand rules to communicate between the device and the third party card readers.

### Before You Start

Wire the third party card readers to the device.

### Steps

---

#### Note

- By default, the device disables the custom wiegand function. If the device enables the custom Wiegand function, all wiegand interfaces in the device will use the customized wiegand protocol.
  - Up to 5 custom Wiegands can be set.
  - For details about the custom Wiegand, see ***Custom Wiegand Rule Descriptions*** .
- 

1. Click **Access Control** → **Advanced Function** → **Custom Wiegand** to enter the Custom Wiegand page.
  2. Select a custom Wiegand on the left.
  3. Create a Wiegand name.
- 

#### Note

Up to 32 characters are allowed in the custom Wiegand name.

---

4. Click **Select Device** to select the access control device for setting the custom wiegand.
  5. Set the parity mode according to the property of the third party card reader.
- 

#### Note

- Up to 80 bits are allowed in the total length.
  - The odd parity start bit, the odd parity length, the even parity start bit and the even parity length range from 1 to 80 bit.
  - The start bit of the card ID, the manufacturer code, the site code, and the OEM should range from 1 to 80 bit.
- 
6. Set output transformation rule.
    - 1) Click **Set Rule** to open the Set Output Transformation Rules window.

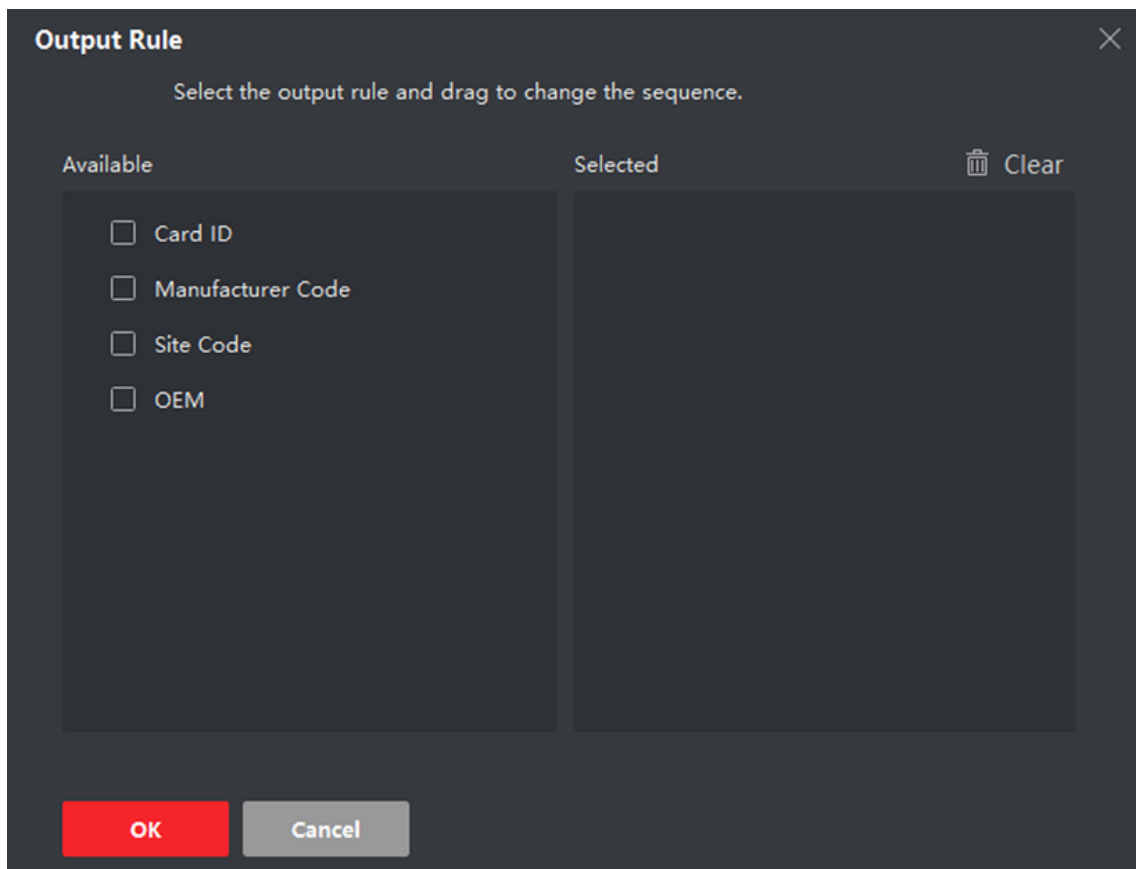

**Figure 15-6 Set Output Transformation Rule**

2) Select rules on the left list.

The selected rules will be added to the right list.

3) **Optional:** Drag the rules to change the rule order.

4) Click **OK**.

5) In the Custom Wiegand tab, set the rule's start bit, length, and the decimal digit.

7. Click **Save**.

### 15.5.5 Configure Card Reader Authentication Mode and Schedule

You can set the passing rules for the card reader of the access control device according to your actual needs.

#### Steps

1. Click **Access Control** → **Advanced Function** → **Authentication** to enter the authentication mode configuration page.
2. Select a card reader on the left to configure.
3. Set card reader authentication mode.
  - 1) Click **Configuration**.



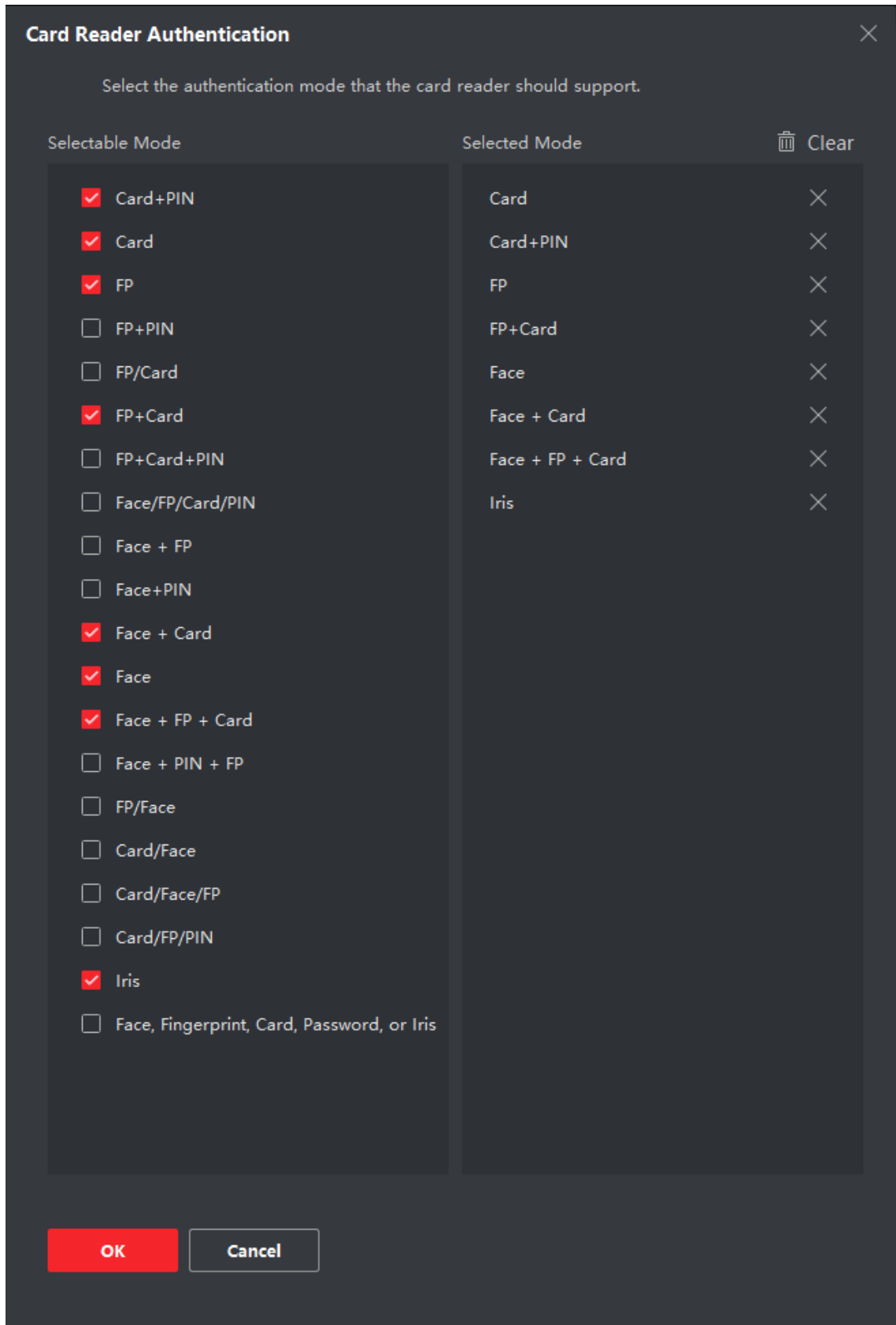

Figure 15-7 Select Card Reader Authentication Mode

## Note

PIN refers to the PIN code set to open the door. Refer to **Configure Access Control Information**.

- 2) Check the modes in the Available Mode list and they will be added to the selected modes list.
- 3) Click **OK**.

After selecting the modes, the selected modes will display as icons with different color.

4. Click the icon to select a card reader authentication mode, and drag the cursor to draw a color bar on the schedule, which means in that period of time, the card reader authentication is valid.
5. Repeat the above step to set other time periods.

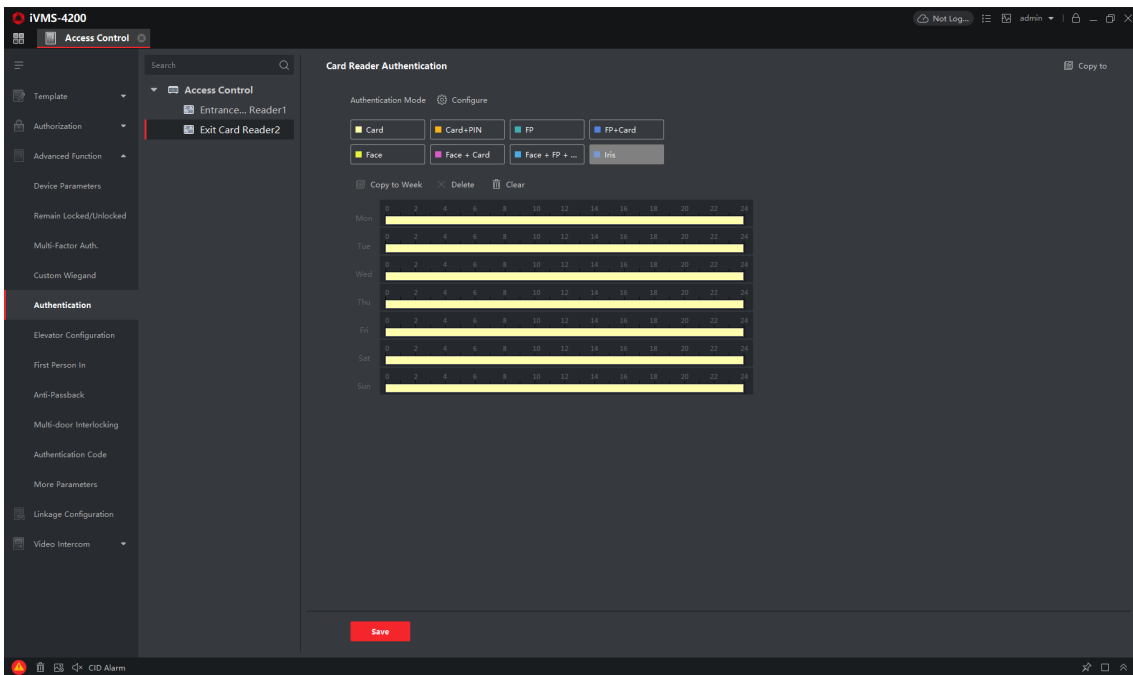

**Figure 15-8 Set Authentication Modes for Card Readers**

6. **Optional:** Select a configured day and click **Copy to Week** to copy the same settings to the whole week.
7. **Optional:** Click **Copy to** to copy the settings to other card readers.
8. Click **Save**.

## 15.5.6 Configure Person Authentication Mode

You can set the passing rules for person to the specified the access control device according to your actual needs.

## Before You Start

- Add access control device to the client, and make sure the access control device support the function of person authentication.
- Add person and assign access authorization to designed person. For details, refer to ***Person Management*** and ***Set Access Group to Assign Access Authorization to Persons*** .

## Steps

1. Click **Access Control** → **Advanced Function** → **Authentication** .
2. Select an access control device (support the function of person authentication) on the left panel to enter the person Authentication Mode page.
3. Click **Add** to enter the Add window.
4. Select the person(s) need to be configured on the left panel.  
The selected person(s) will be added to the right panel.
5. Select the authentication mode on the drop-down list of **Authentication Mode**.
6. Click **OK**.

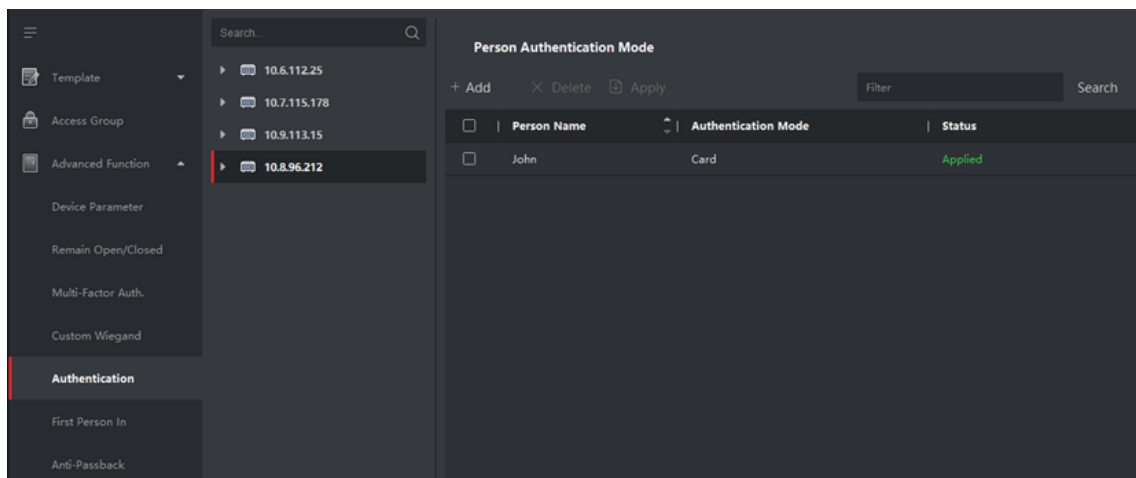

**Figure 15-9 Set Authentication Modes for Persons**

7. **Optional:** Select person(s) on the Person Authentication mode page, and then click **Apply** to apply the person authentication mode to the device.

---

### Note

Person authentication has higher priority than other authentication mode. When the access control device has been configured person authentication mode, the person should authenticate on this device via person authentication mode.

---

## 15.5.7 Configure Relay for Elevator Controller

For elevator controller, you can manage the relationship between the floor and the relay and configure the floor's relay type. Different relay type can implement different functions. By

configuring the relationship between the floor and the relay, you can assign different functions to the elevator and control the elevator.

## Configure Relationship between Relay and Floor

You can assign different relay types to the target floors, and each floor can be assigned with 3 relay types. By this way, you can call the elevator, and assign the operations for different floors.

### Before You Start

Add the elevator controller to the client.

### Steps

1. Click **Access Control** → **Advanced Function** → **Elevator Configuration** to enter the Relay Settings page.
2. Select an elevator controller on the left.
3. Select an unconfigured relay in the Unconfigured Relay panel on the right.

There are three types of relay available.

#### Button

Control the validity for buttons of each floor.



 represents button relay.

---

#### Call Elevator

Control to call the elevator to go to the specified floor by indoor station or outdoor station.



 represents the call elevator relay.

---

#### Auto

Control to press the button when the user swipes card inside the elevator. The button of the floor will be pressed automatically according to the user's permission.



 represents the auto button relay.

---

### Example

Take the following picture as an example. In the number 1-2, 1 represents the distributed elevator controller number, 2 represents the relay, and the icon  represents the relay type. You can change the relay type. For details, refer to [\*\*\*Configure Relay Type\*\*\*](#) .

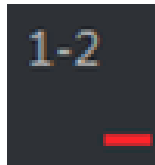

Figure 15-10 Relay

4. Configure the relationship between the relays and the floors.
  - Drag the unconfigured relay from the Unconfigured Relay panel to the target floor in the Floor List panel.
  - Drag the relay from the Floor List panel to the Unconfigured Relay panel.
  - Drag the relay from one floor to another floor in the Floor List panel. If the target floor has already configured with a relay of the same type as the dragged one, it will replace the existed one of the same type.

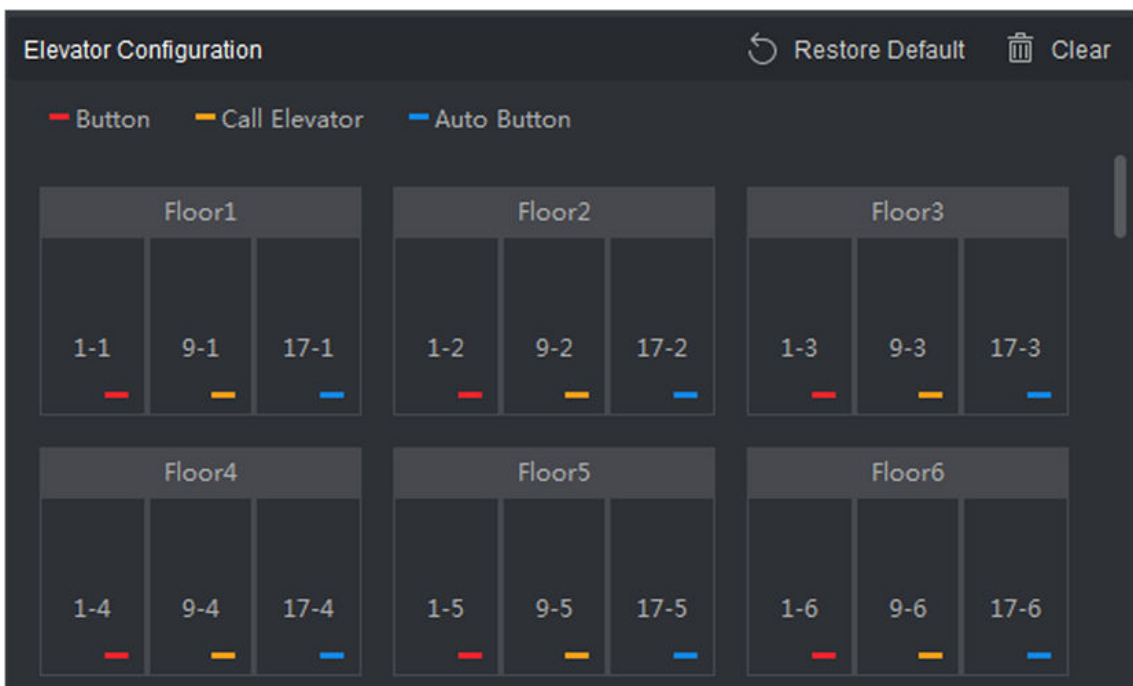

Figure 15-11 Relationship between Relay and Floor

 **Note**

- An elevator controller can link to up to 24 distributed elevator controllers. A distributed elevator controller can link up to 16 relays.
- By default, the relay total amount is the added floor number \*3 (three types of relay).
- Up to 3 types of relay can be dragged to one floor.
- If you change the floor number in the door group management, all relays in the Relay Settings interface will restore to the default settings.

5. Click **Save** to apply the settings to the selected elevator controller.

## Configure Relay Type



To implement different functions, you can configure different relay type, including: button relay, call elevator relay and auto button relay. Different relay type can implement different functions. The button relay is to control the validity for buttons of each floor.. The call elevator relay is to call the elevator to the specified floor by indoor station or outdoor station. The auto button relay is to control to press the button when the user swipes card inside the elevator, the button of the floor will be pressed automatically according to the user's permission.

### Steps

1. Click **Access Control** → **Advanced Function** → **Elevator Configuration** to enter the Relay Settings page.
2. Select an elevator controller on the left of the page.
3. Click **Relay Type Settings** to open the Relay Type Settings window.

---

#### Note

- All relays in the Relay Type Settings window are unconfigured relays.
- Three types of relay are available:  represents the button relay,  represents the call elevator relay, and  represents the auto button relay.

- 
4. Drag the relay from one relay type panel to the target one.

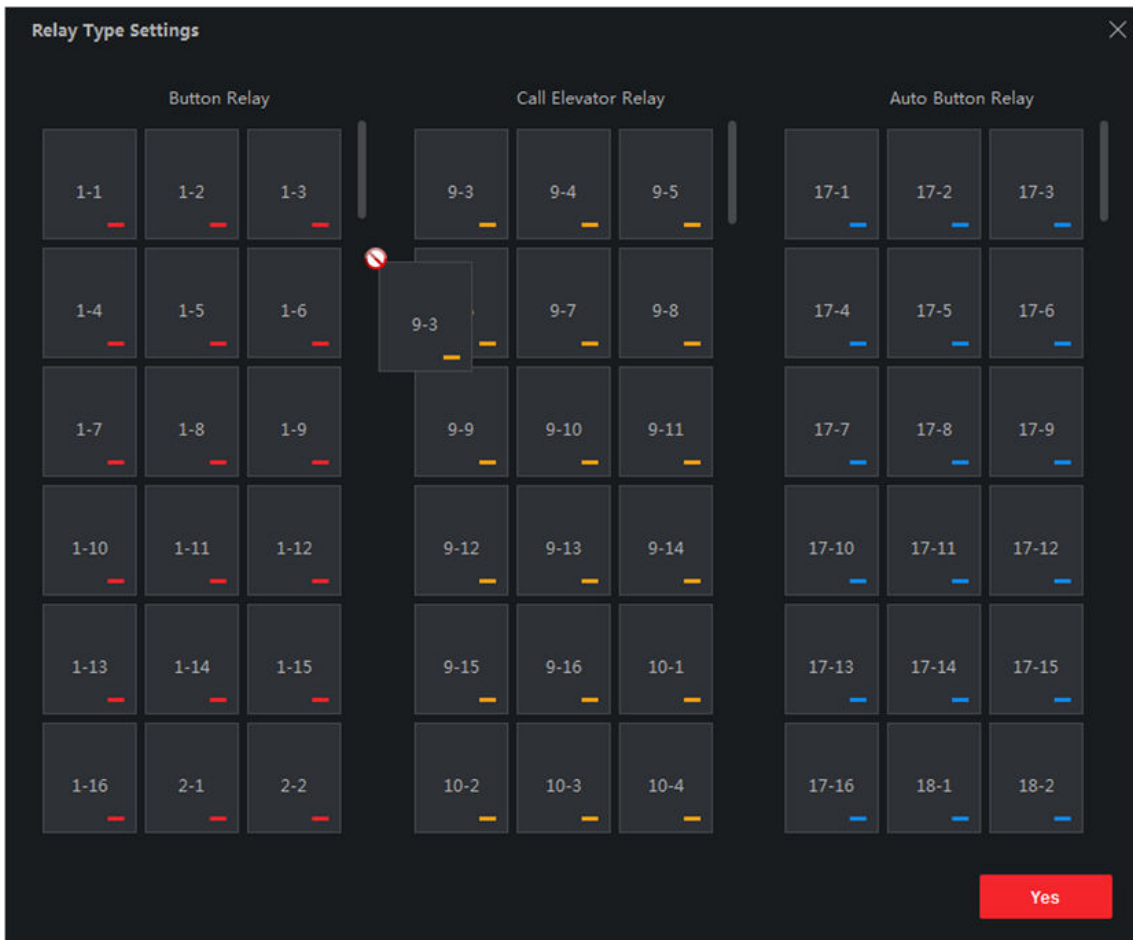

Figure 15-12 Configure Relay Type

5. Click OK.

### 15.5.8 Configure First Person In

You can set multiple first persons for one access control point. After the first person is authorized, it allows multiple persons access the door or other authentication actions.

#### Before You Start

- Add access control device to the client, and make sure the device supports the first person in function.
- Add person and assign access authorization to designed person. For details, refer to ***Person Management*** and ***Set Access Group to Assign Access Authorization to Persons*** .

#### Steps

1. Click **Access Control** → **Advanced Function** → **First Person In** to enter the First Person In page.
2. Select an access control device in the list on the left panel.

3. Select the current mode as **Enable Remaining Open after First Person**, **Disable Remaining Open after First Person**, or **Authorization by First Person** from the drop-down list for each access control point of the selected device.

### **Enable Remaining Open after First Person**

The door remains open for the configured time duration after the first person is authorized until the remain open duration ends. If you select this mode, you should set the consecutive authentication times and interval of consecutive authentication.

---

#### **Note**

The remain open duration should be between 0 and 1440 minutes. By default, the remain open duration is 10 minutes.

---

### **Disable Remaining Open after First Person**

Disable the function of first person in, namely normal authentication.

### **Authorization by First Person**

All authentications (except for the authentications of super card, super password, duress card, and duress code) are allowed only after the first person authorization.

---

#### **Note**

You can authenticate by the first person again to disable the first person mode.

---

4. Click **Add** on the First Person List panel.
5. Select person(s) in the left list and the person(s) will be add to the selected persons as the first person(s) of the doors.  
The added first person(s) will list in the First Person List
6. **Optional:** Select a first person from the list and click **Delete** to remove the person from the first person list.
7. Click **Save**.

## **15.5.9 Configure Anti-Passback**

The anti-passback feature is designed to minimizes the misuse or fraudulent use of access credentials such as passing back card to an unauthorized person, or tailed access. The anti-passback function establishes a specific sequence in which access credentials must be used in order to grant access. You can set the sequence according to the actual path via the client and if the person uses the credential in wrong sequence, you can also reset the anti-password records.

### **Before You Start**

Add access control device to the client, and enable the anti-passing back function of the access control device.



## Steps

---

### Note

Either the anti-passing back or multi-door interlocking function can be configured for an access control device at the same time. For the configuration of multi-door interlocking, refer to ***Configure Multi-door Interlocking*** .

---

1. Click **Access Control** → **Advanced Function** → **Anti-Passback** to enter the Anti-Passpack Settings page.
  2. Select an access control device on the left panel.
  3. Select a card reader as the beginning of the path in the **First Card Reader** field.
  4. Click  of the selected first card reader in the **Card Reader Afterward** column to open the select card reader dialog.
  5. Select the afterward card readers for the first card reader.
- 

### Note

Up to four afterward card readers can be added as afterward card readers for one card reader.

---

6. Click **OK** in the dialog to save the selections.
7. Click **Save** in the Anti-Passback Settings page to save the settings and take effect.

### Example

Set Card Swiping Path: If you select Reader In\_01 as the beginning, and select Reader In\_02, Reader Out\_04 as the linked card readers. Then you can only get through the access control point by swiping the card in the order as Reader In\_01, Reader In\_02 and Reader Out\_04.

8. Click **Reset Anti-Passback** and select the person(s) to delete the related anti-passback records about the person(s) on the device.
- 

### Note

This function should be supported by the device.

---

## 15.5.10 Configure Multi-door Interlocking

You can set the multi-door interlocking between multiple doors of the same access control device. To open one of the doors, other doors must keep closed. That means in the interlocking combined door group, up to one door can be opened at the same time.

### Before You Start

Add access control device to the client, and make sure the device supports the multi-door interlocking function.

### Steps

---

#### Note

- Multi-door Interlocking function is only supported by the access control device which has more than one access control points (doors).
  - Either the anti-passing back or multi-door interlocking function can be configured for an access control device at the same time. For the configuration of anti-passing back function, refer to ***Configure Anti-Passback*** .
- 

1. Click **Access Control** → **Advanced Function** → **Multi-door Interlocking** .
  2. Select an access control device on the left panel.
  3. Click **Add** on the Multi-door Interlocking List panel to open Add Access Control Point to open the Add window.
  4. Select at least two access control points(doors) from the list.
- 

#### Note

Up to four doors can be added in one multi-door interlocking combination.

---

5. Click **OK** to add the selected access control point(s) for interlocking.  
The configured multi-door interlocking combination will list on the Multi-door Interlocking List panel.
  6. **Optional:** Select an added multi-door interlocking combination from the list and click **Delete** to delete the combination.
  7. Click **Apply** to apply the settings to the access control device.
- 

### 15.5.11 Configure Authentication Code

You can configure authentication code on the client. And after that, you can open door by entering authentication code when you forget to bring the card with you.

#### Before You Start

Add access control device to the client, and make sure the device supports authentication code as the authentication mode.

### Steps

1. Click **Access Control** → **Advanced Function** → **Authentication Code** to enter the authentication code configuration page.
  2. Select an access control device in the list of Controller List panel.  
All the applied cards and persons will display on the Card List panel.
- 

#### Note

For setting and applying the permissions to the device, refer to ***Set Access Group to Assign Access Authorization to Persons*** .

---

3. Click the field of each card in the Authentication Code column to enter the authentication code.
-



The authentication code should contain 4 to 8 digits.

4. Click **Save** at the upper-right corner of Authentication Code page to save the settings.

The authentication code function of the card will be enabled automatically.

### What to do next

You should set the card reader authentication mode of access control device as **Card/Authentication Code**. Refer to [\*\*\*Configure Card Reader Authentication Mode and Schedule\*\*\*](#) for details.

## 15.6 Configure Other Parameters

After adding the access control device, you can set its parameters such as network parameters, capture parameters, RS-485 parameters, Wiegand parameters, etc.

### 15.6.1 Set Multiple NIC Parameters

If the device supports multiple network interfaces, you can set the network parameters of these NICs via the client, such as IP address, MAC address, port number, etc.

#### Before You Start

Add access control device to the client, and make sure the device supports multiple NICs.

#### Steps

1. Enter the Access Control module.
2. On the navigation bar on the left, enter **Advanced Function → More Parameters**.
3. Select an access control device in the device list and click **NIC** to enter Multiple NIC Settings page.
4. Select an NIC you want to configure from the drop-down list.
5. Set its network parameters such as IP address, default gateway, subnet mask, etc.

#### MAC Address

A media access control address (MAC address) is a unique identifier assigned to the network interface for communications on the physical network segment.

#### MTU

The maximum transmission unit (MTU) of the network interface.

6. Click **Save**.

### 15.6.2 Set Network Parameters

After adding the access control device, you can set the device log uploading mode, and create ISUP account via wired or wireless network.

## Set Log Uploading Mode

You can set the mode for the device to upload logs via ISUP protocol.

### Steps

1. Enter the Access Control module.
  2. On the navigation bar on the left, enter **Advanced Function → More Parameters** .
  3. Select an access control device in the device list and enter **Network → Uploading Mode** .
  4. Select the center group from the drop-down list.
  5. Check **Enable** to enable to set the uploading mode.
  6. Select the uploading mode from the drop-down list.
    - Enable **N1** or **G1** for the main channel and the backup channel.
    - Select **Close** to disable the main channel or the backup channel
- 



The main channel and the backup channel cannot enable N1 or G1 at the same time.

---

7. Click **Save**.

## Create ISUP Account in Wired Communication Mode

You can set the account for ISUP protocol in wired communication mode. Then you can add devices via ISUP protocol.

### Steps



This function should be supported by the device.

---

1. Enter the Access Control module.
  2. On the navigation bar on the left, enter **Advanced Function → More Parameters** .
  3. Select an access control device in the device list and enter **Network → Network Center** .
  4. Select the center group from the drop-down list.
  5. Select the **Address Type** as **IP Address** or **Domain Name**.
  6. Enter IP address or domain name according to the address type.
  7. Enter the port number for the protocol.
- 



The port number of the wireless network and wired network should be consistent with the port number of ISUP.

---

8. Select the **Protocol Type** as **ISUP**.
9. Set an account name for the network center.
10. Click **Save**.

## Create ISUP Account in Wireless Communication Mode

You can set the account for ISUP protocol in wireless communication mode. Then you can add devices via ISUP protocol.

### Steps

---



This function should be supported by the device.

---

1. Enter the Access Control module.
  2. On the navigation bar on the left, enter **Advanced Function → More Parameters** .
  3. Select an access control device in the device list and enter **Network → Wireless Communication Center** .
  4. Select the **APN Name** as **CMNET** or **UNINET**.
  5. Enter the SIM Card No.
  6. Select the center group from the drop-down list.
  7. Enter the IP address and port number.
- 



- By default, the port number for ISUP is **7660**.
  - The port number of the wireless network and wired network should be consistent with the port number of ISUP.
- 
8. Select the **Protocol Type** as **ISUP**.
  9. Set an account name for the network center.
  10. Click **Save**.

### 15.6.3 Set Device Capture Parameters

You can configure the capture parameters of the access control device, including manual capture and event triggered capture.

---



- The capture function should be supported by the device.
  - Before setting the capture parameters, you should set the picture storage first to define where the event triggered pictures are saved. For details, refer to **Set Picture Storage** .
- 

### Set Triggered Capture Parameters

When an event occurs, the camera of the access control device can be triggered to capture picture(s) to record what happens when the event occurs. You can view the captured pictures

when checking the event details in Event Center. Before that, you need to set the parameters for the capture such as number of pictures captured for one time.

### Before You Start

Before setting the capture parameters, you should set the picture storage first to define where the captured pictures are saved. For details, refer to [Set Picture Storage](#) .

### Steps

---



This function should be supported by the device

---

1. Enter the Access Control module.
2. On the navigation bar on the left, enter **Advanced Function** → **More Parameters** → **Capture** .
3. Select an access control device in the device list and select **Linked Capture**.
4. Set the picture size and quality.
5. Set the capture times once triggered which defines how many pictures will be captures for one time.
6. If the capture times is more than 1, set the interval for each capture.
7. Click **Save**.

### Set Manual Capture Parameters

In Status Monitoring module, you can capture a picture manually the access control device's camera by clicking a button. Before that, you need to set the parameters for the capture such as picture quality.

### Before You Start

Before setting the capture parameters, you should set the saving path first to define where the captured pictures are saved. For details, refer to [Set File Saving Path](#) .

### Steps

---



This function should be supported by the device

---

1. Enter the Access Control module.
2. On the navigation bar on the left, enter **Advanced Function** → **More Parameters** → **Capture** .
3. Select an access control device in the device list and select **Manual Capture**.
4. Select the resolution of the captured pictures from the drop-down list.
5. Select the picture quality as **High**, **Medium**, or **Low**. The higher the picture quality is, the larger size the picture will be.
6. Click **Save**.

## 15.6.4 Set Parameters for Face Recognition Terminal

For face recognition terminal, you can set its parameters including face picture database, QR code authentication, etc.

### Steps

---



This function should be supported by the device.

---

1. Enter the Access Control module.
  2. On the navigation bar on the left, enter **Advanced Function → More Parameters**.
  3. Select an access control device in the device list and click **Face Recognition Terminal**.
  4. Set the parameters.
- 



These parameters displayed vary according to different device models.

---

### COM

Select a COM port for configuration. COM1 refers to the RS-485 interface and COM2 refers to the RS-232 interface.

### Face Picture Database

select Deep Learning as the face picture database.

### Authenticate by QR Code

If enabled, the device camera can scan the QR code to authenticate. By default, the function is disabled.

### Blocklist Authentication

If enabled, the device will compare the person who want to access with the persons in the blocklist.

If matched (the person is in the blocklist), the access will be denied and the device will upload an alarm to the client.

If mismatched (the person is not in the blocklist), the access will be granted.

### Save Authenticating Face Picture

If enabled, the captured face picture when authenticating will be saved on the device.

### MCU Version

View the device MCU version.

5. Click **Save**.

## 15.6.5 Enable M1 Card Encryption

M1 card encryption can improve the security level of authentication.

### Steps



The function should be supported by the access control device and the card reader.

---

1. Enter the Access Control module.
2. On the navigation bar on the left, enter **Advanced Function → More Parameters** .
3. Select an access control device in the device list and click **M1 Card Encryption** to enter the M1 Card Encryption page.
4. Set the switch to on to enable the M1 card encryption function.
5. Set the sector ID.  
The sector ID ranges from 1 to 100.
6. Click **Save** to save the settings.

## 15.6.6 Set RS-485 Parameters

You can set the access control device's RS-485 parameters including the baud rate, data bit, the stop bit, parity type, flow control type, communication mode, work mode, and connection mode.

### Before You Start

Add access control device to the client, and make sure the device supports RS-485 interface.

### Steps

1. Enter the Access Control module.
2. On the navigation bar on the left, enter **Advanced Function → More Parameters** .
3. Select an access control device in the device list and click **RS-485** to enter the RS-485 Settings page.
4. Select the serial port number from the drop-down list to set the RS-485 parameters.
5. Set the baud rate, data bit, the stop bit, parity type, communication mode, working mode, and connection mode in the drop-down list.



When the connection mode is **Connect Access Control Device**, you can select **Card No.** or **Person ID** as the output type.

---

6. Click **Save**.
  - The configured parameters will be applied to the device automatically.
  - When you change the working mode or connection mode, the device will reboot automatically.



### 15.6.7 Set Wiegand Parameters

You can set the access control device's Wiegand channel and the communication mode. After setting the Wiegand parameters, the device can connect to Wiegand card reader via Wiegand communication.

#### Before You Start

Add access control device to the client, and make sure the device supports Wiegand.

#### Steps

1. Enter the Access Control module.
2. On the navigation bar on the left, enter **Advanced Function** → **More Parameters** .
3. Select an access control device in the device list and click **Wiegand** to enter the Wiegand Settings page.
4. Set the switch to on to enable the Wiegand function for the device.
5. Select the Wiegand channel No. and the communication mode from the drop-down list.



#### Note

If you set **Communication Direction** as **Sending**, you are required to set the **Wiegand Mode** as **Wiegand 26** or **Wiegand 34**.

---

6. Click **Save**.
  - The configured parameters will be applied to the device automatically.
  - After changing the communication direction, the device will reboot automatically.

## 15.7 Configure Linkage Actions for Access Control

You can configure different linkage actions for the event detected by the access control device. After that, linkage actions will be triggered once the event happens. This mechanism is used for notifying the security personnel the event, or triggering automatic access control in real time.

Two types of linkage actions are supported:

- **Client Actions:** When the event is detected, it will trigger the actions on the client, such as the client making an audible warning..
- **Device Actions:** When the event is detected, it will trigger the actions of a specific device, such as buzzing of a card reader and, opening/closing of a door, ..

### 15.7.1 Configure Client Actions for Access Event

Even if you are far away from an access point, you can still know what happens and how urgent the event is via the client by configuring client actions for the access event. Client actions here refer to the actions automatically executed by the client itself, such as making an audible warning and

sending an email. Once an event is triggered, the client will notify the security personnel, so that he/she can handle the event in time.

### **Before You Start**

Add access control device to the client.

### **Steps**

#### **1. Click *Event Configuration* → *Access Control Event* .**

The added access control devices will display in the device list.

#### **2. Select a resource (including device, alarm input, door/elevator, and card reader) from the device list.**

The event types which the selected resource supports appear.

#### **3. Select the event(s) and click *Edit Priority* to define the priority for the event(s), which can be used to filter events in the Event Center.**

#### **4. Set the linkage actions of the event.**

1) Select the event(s) and click **Edit Linkage** to set the client actions when the event(s) are triggered.

### **Audible Warning**

The client software gives an audible warning when the event is triggered. You can select alarm sound for the audible warning.



For details about setting the alarm sound, refer to ***Set Alarm Sound*** .

---

### **Send Email**

Send an email notification about the event to one or more receivers.

For details about setting email parameters, refer to ***Set Email Parameters*** .

### **Pop-up Window**

Pop-up a window to display the event information (including event details, the event-related video footage, the event-related picture) on the software client when the event is triggered.

### **Display on Map**

When the event source is added as a hot spot on the map, the hot spot will be displayed with red number (indicates the number of events, and the maximum number is 10) aside when the event is triggered, which helps the security personnel to view the location of the event.

You can also click the hot spot to view the event details and the live video of the linked camera.

### **Linked Camera**

Link the selected camera to capture a picture when the access event is triggered.

Select the camera in the drop-down list.

2) Click **OK**.

5. Enable the event so that when the event is detected, event will be sent to the client and the linkage actions will be triggered.
6. **Optional:** Click **Copy to** to copy the event settings to other access control device, alarm input, door/elevator, or card reader.

### 15.7.2 Configure Device Actions for Access Event

You can set the access control device's linkage actions for the access control device's triggered event. After that, when an event is triggered, it can trigger the alarm output, buzzer on access controller, and other actions.

#### Steps

---



The linkage actions should be supported by the device.

---

1. Click **Access Control → Linkage Configuration** .
2. Select the access control device from the list on the left.
3. Click **Add** to add a new linkage.
4. Select **Event Linkage** as the event source.
5. select the event type and detailed event to set the linkage.
6. In the Linkage Target area, set the property target to enable this action.

#### **Buzzer on Controller**

The audible warning of access control device will be triggered.

#### **Capture**

An event-related picture will be captured when the selected event happens.

#### **Recording**

An event-related picture will be captured when the selected event happens.

---



The device should support recording.

---

#### **Buzzer on Reader**

The audible warning of card reader will be triggered.

#### **Alarm Output**

The alarm output will be triggered for notification when the selected event happens

#### **Alarm Input**

Arm or disarm the alarm input.

---

 **Note**

The device should support alarm input function.

---

**Access Point**

The door status of open, close, remain open, or remain close will be triggered.

---

 **Note**

The target door and the source door cannot be the same one.

---

**Audio Play**

The audio prompt will be triggered. And the select audio index related audio content will be played according to the configured play mode.

7. Click **Save**.

8. **Optional:** After adding the device linkage, you can do one or more of the followings:

<b>Edit Linkage Settings</b>	Select the configured linkage settings in the device list and you can edit its event source parameters, including event source and linkage target.
<b>Delete Linkage Settings</b>	Select the configured linkage settings in the device list and click <b>Delete</b> to delete it.

## 15.7.3 Configure Device Actions for Card Swiping

You enable access control device's linkage actions (such as disarming a zone and triggering audio prompt) for the swiping of a specific card, In this way, you can monitor the card holder's behaviors and whereabouts.

**Steps**

---

 **Note**

It should be supported by the device.

---

1. Click **Access Control → Linkage Configuration** .
2. Select the access control device from the list on the left.
3. Click **Add** to add a new linkage.
4. Select **Card Linkage** as the event source.
5. Enter the card number or select the card from the drop-down list.
6. Select the card reader where the card swipes.
7. In the Linkage Target area, set the property target to enable this action.

**Buzzer on Controller**

The audible warning of access control device will be triggered.

**Buzzer on Reader**

The audible warning of card reader will be triggered.

## Capture

An event-related picture will be captured when the selected event happens.

## Recording

An event-related picture will be captured when the selected event happens.



### Note

The device should support recording.

---

## Alarm Output

The alarm output will be triggered for notification.

## Alarm Input

Arm or disarm the alarm input.



### Note

The device should support alarm input function.

---

## Access Point

The door status of open, close, remain open, or remain closed will be triggered.

## Audio Play

The audio prompt will be triggered. And the select audio index related audio content will be played according to the configured play mode.

### 8. Click **Save**.

When the card (configured in Step 5) swipes on the card reader (configured in Step 6), it can trigger the linked actions (configured in step 7).

### 9. **Optional**: After adding the device linkage, you can do one or more of the followings:

- |                                |  |
|--------------------------------|--|
| <b>Delete Linkage Settings</b> | Select the configured linkage settings in the device list and click <b>Delete</b> to delete it.  |
| <b>Edit Linkage Settings</b>   | Select the configured linkage settings in the device list and you can edit its event source parameters, including event source and linkage target. |

## 15.7.4 Configure Device Actions for Person ID

You can set the access control device's linkage actions for the specified person ID. When access control device detects the specified person ID, it can trigger the alarm output, buzzer on card reader, and other actions, so as to implement special monitoring on the specified person.

### Steps

---



### Note

It should be supported by the device.

---

1. Click **Access Control → Linkage Configuration** .
2. Select the access control device from the list on the left.
3. Click **Add** to add a new linkage.
4. Select **Person Linkage** as the event source.
5. Enter the employee number or select the person from the drop-down list.
6. Select the card reader where the card swipes.
7. In the Linkage Target area, set the property target to enable this action.

### **Buzzer on Controller**

The audible warning of access control device will be triggered.

### **Buzzer on Reader**

The audible warning of card reader will be triggered.

### **Capture**

An event-related picture will be captured when the selected event happens.

### **Recording**

An event-related picture will be captured when the selected event happens.



### **Note**

The device should support recording.

---

### **Alarm Output**

The alarm output will be triggered for notification.

### **Alarm Input**

Arm or disarm the alarm input.



### **Note**

The device should support zone function.

---

### **Access Point**

The door status of open, close, remain open, or remain closed will be triggered.

### **Audio Play**

The audio prompt will be triggered. And the select audio index related audio content will be played according to the configured play mode.

8. Click **Save**.
9. **Optional:** After adding the device linkage, you can do one or more of the followings:

<b>Delete Linkage Settings</b>	Select the configured linkage settings in the device list and click <b>Delete</b> to delete it.
<b>Edit Linkage Settings</b>	Select the configured linkage settings in the device list and you can edit its event source parameters, including event source and linkage target.

## 15.8 Door/Elevator Control

In Monitoring module, you can view the real-time status of the doors or elevators managed by the added access control device. You can also control the doors and elevators such as open/close the door, or remain the door open/closed via the client remotely. The real-time access event are displayed in this module. You can view the access details and person details.

---

### Note

For the user with door/elevator control permission, the user can enter the Monitoring module and control the door/elevator. Or the icons used for control will not show. For setting the user permission, refer to [Add User](#) .

---

### 15.8.1 Control Door Status

You can control the status for the door(s), including unlock door, locking door, remaining the door unlock, remaining the door locked, remain all unlocked, etc.

#### Before You Start

- Add person and assign access authorization to designed person, and person will have the access authorization to the access points (doors). For details, refer to [Person Management](#) and [Set Access Group to Assign Access Authorization to Persons](#) .
- Make sure the operation user has the permission of the access points (doors). For details, refer to [Add User](#) .

#### Steps

1. Click **Monitoring** to enter the status monitoring page.
2. Select an access point group on the upper-right corner.

---

### Note

For managing the access point group, refer to [Group Management](#) .

---

The doors in the selected access control group will display.

3. Click a door icon to select a door, or press **Ctrl** and select multiple doors.

---

### Note

For **Remain All Unlocked** and **Remain All Locked**, ignore this step.

---

4. Click the following buttons to control the door.

#### Unlock

When the door is locked, unlock it and it will be open for once. After the open duration, the door will be closed and locked again automatically.

#### Lock

When the door is unlocked, lock it and it will be closed. The person who has the access authorization can access the door with credentials.

### **Remain Unlocked**

The door will be unlocked (no matter closed or open). All the persons can access the door with no credentials required.

### **Remain Locked**

The door will be closed and locked. No person can access the door even if he/she has the authorized credentials, except the super users.

### **Remain All Unlocked**

All doors in the group will be unlocked (no matter closed or open). All the persons can access the doors with no credentials required.

### **Remain All Locked**

All doors in the group will be closed and locked. No person can access the doors even if he/she has the authorized credentials, except the super users.

### **Capture**

Capture a picture manually.



#### **Note**

The **Capture** button is available when the device supports capture function. The picture is saved in the PC running the client. For setting the saving path, refer to **Set File Saving Path** .

---

### **Result**

The icon of the doors will change in real-time according to the operation if the operation is succeeded.

## **15.8.2 Control Elevator Status**

You can control the elevator status of the added elevator controller, including opening elevator's door, controlled, free, calling elevator, etc.

### **Before You Start**

- Add person and assign access authorization to designed person, and person will have the access authorization to the access points (floors). For details, refer to **Person Management** and **Set Access Group to Assign Access Authorization to Persons** .
- Make sure the operation user has the permission of the access points (floors). For details, refer to **Add User** .



## Steps

---

### Note

- You can control the elevator via the current client if it is not armed by other client. The elevator cannot be controlled by other client software if the elevator status changes.
  - Only one client software can control the elevator at one time.
  - The client which has controlled the elevator can receive the alarm information and view the elevator real-time status.
- 

1. Click **Monitoring** to enter the status monitoring page.
  2. Select an access point group on the upper-right corner.
- 

### Note

For managing the access point group, refer to ***Group Management*** .

---

The elevators in the selected access point group will display.

3. Click a door icon to select an elevator.
4. Click the following buttons to control the elevator.

#### **Open Door**

When the elevator's door is closed, open it. After the open duration, the door will be closed again automatically.

#### **Controlled**

You should swipe the card before pressing the target floor button. And the elevator can go to the target floor.

#### **Free**

The selected floor's button in the elevator will be valid all the time.

#### **Disabled**

The selected floor's button in the elevator will be invalid and you cannot go to the target floor.

## Result

The icon of the doors will change in real-time according to the operation if the operation is succeeded.

## 15.8.3 Check Real-Time Access Records

The real-time access records can be displayed in the client, including card swiping records, face recognition records, skin-surface temperature information, etc. Also, you can view the person information and view the picture captured during access.

## Before You Start

You have added person(s) and access control device(s) to the client. For details, refer to ***Person Management*** and ***Add Device***.

## Steps

1. Click **Monitoring** to enter monitoring module.

Real-time access records are displayed on the bottom of the page. You can view record details, including card No., person name, event time, door location, temperature, authentication type etc.

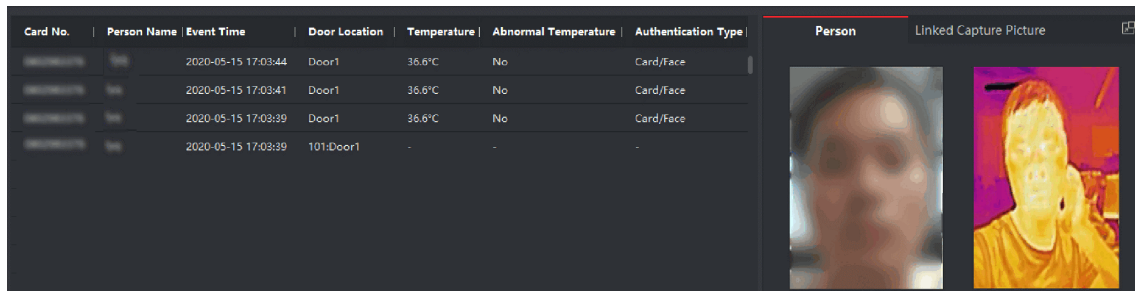

Card No.	Person Name	Event Time	Door Location	Temperature	Abnormal Temperature	Authentication Type
		2020-05-15 17:03:44	Door1	36.6°C	No	Card/Face
		2020-05-15 17:03:41	Door1	36.6°C	No	Card/Face
		2020-05-15 17:03:39	Door1	36.6°C	No	Card/Face
		2020-05-15 17:03:39	101:Door1	-	-	-

Figure 15-13 Real-time Access Records

### Note

You can right click the column name of access event table to show or hide the column according to actual needs.

2. **Optional:** Select an access point group from the drop-down list in the upper-right corner to show the real time access records of the selected group.

3. **Optional:** Check the event type and event status.

The detected events of checked type and status will be displayed in the list below.

4. **Optional:** Check **Show Latest Event** to view the latest access record.

The record list will be listed reverse chronologically.

5. **Optional:** Check **Enable Abnormal Temperature Prompt** to enable abnormal skin-surface temperature prompt.

### Note

When enabled, if there is abnormal temperature information, an Abnormal Temperature window pops up when you enter Monitoring module, displaying person's picture, skin-surface temperature, card No., person name, etc.

6. **Optional:** Click an event to view person pictures (including captured picture and profile).

### Note

In **Linked Capture Picture** field, you can double click the captured picture to view an enlarged picture.

7. **Optional:** Click  to view surveillance details (including person's detailed information and the captured picture).

---

 **Note**

In the pop-up window, you can click  to view surveillance details in full screen.

---

## Chapter 16 Time and Attendance

The Time and Attendance module provides multiple functionalities to track and monitor when employees start and stop work, and full control of employees working hours such as late arrivals, early departures, time taken on breaks and absenteeism.

### Note

In this section, we introduce the configurations before you can getting the attendance reports. The access records recorded after these configurations will be calculated in the statistics.

### 16.1 Flow Chart

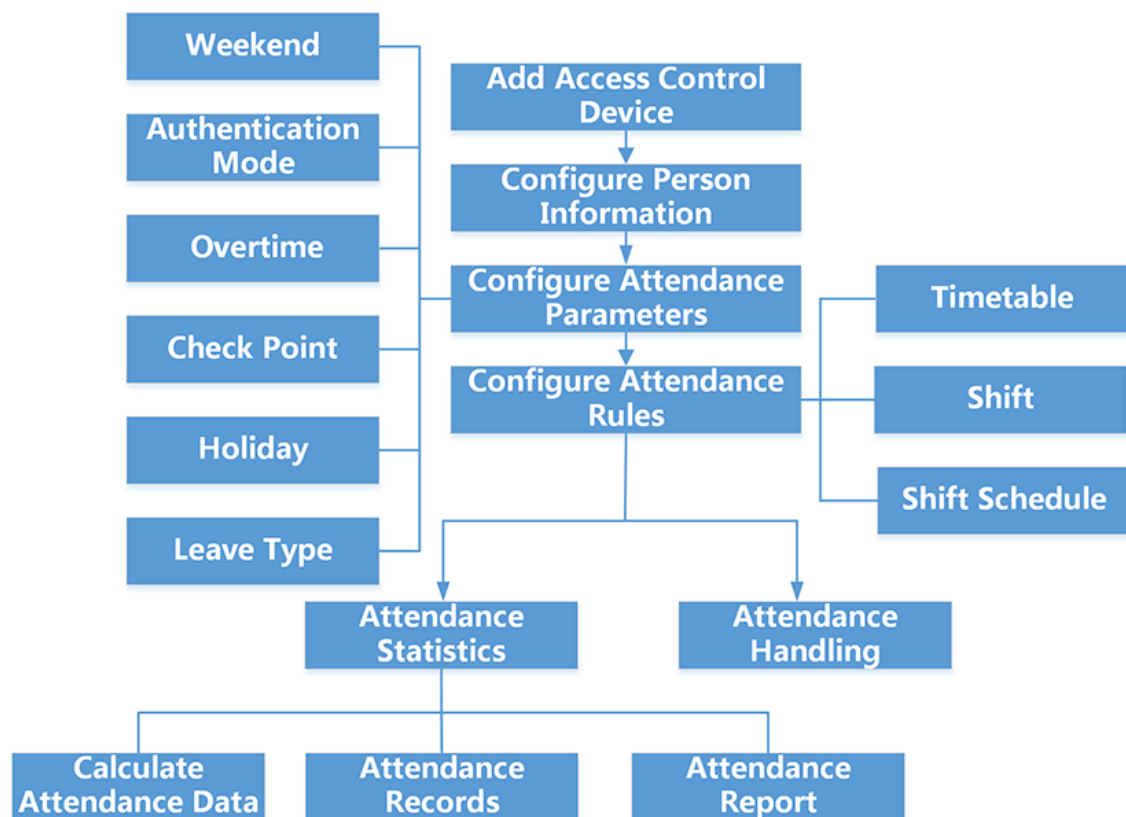

Figure 16-1 Flow Chart of Time and Attendance

- **Add Access Control Device:** You can add access control devices on the client. For more details, refer to [Add Device](#) .
- **Configure Person Information:** You should add person information to the client before configuring time and attendance parameters for them. For more details, refer to [Person Management](#) .

- **Set Weekend:** You can select one or more days as the weekends according to actual requirements on the client. For more details, refer to [\*\*\*Set Weekend\*\*\*](#) .
- **Configure Authentication Mode:** You can configure authentication mode such as card, fingerprint, face, etc. For more details, refer to [\*\*\*Object Missing\*\*\*](#) .
- **Configure Overtime Parameters:** You can configure the overtime parameters for workday and weekend, including overtime level, work hour rate, etc. For more details, refer to [\*\*\*Configure Overtime Parameters\*\*\*](#) .
- **Configure Attendance Check Point:** You can set the card reader(s) of the access point as the attendance check point on the client. For more details, refer to [\*\*\*Configure Overtime Parameters\*\*\*](#) .
- **Configure Holiday:** You can add the holiday during which the check-in or check-out will not be recorded on the client. For more details, refer to [\*\*\*Configure Holiday\*\*\*](#) .
- **Configure Leave Type:** You can customize the leave type according to actual needs. For more details, refer to [\*\*\*Configure Leave Type\*\*\*](#) .
- **Add Timetable:** You can add general timetable and flexible timetable for employees on the client according to actual needs. For more details, refer to [\*\*\*Add Flexible Timetable\*\*\*](#) and [\*\*\*Add General Timetable\*\*\*](#) .
- **Add Shift:** You can add shift for employees including setting shift periods and the effective attendance time. For more details, refer to [\*\*\*Add Shift\*\*\*](#) .
- **Manage Shift Schedule:** You can set department schedule, person schedule, and temporary schedule on the client. For more details, refer to [\*\*\*Manage Shift Schedule\*\*\*](#) .
- **Calculate Attendance Data:** The client can calculate the attendance data automatically or you can manually calculate the attendance data. For more details, refer to [\*\*\*Calculate Attendance Data\*\*\*](#) .
- **Attendance Records:** You can search and view the employee's attendance records on the client, including attendance time, attendance status, check point, etc. For more details, refer to [\*\*\*Get an Overview of Employees' Attendance Data\*\*\*](#) .
- **Attendance Report:** The client supports generating attendance reports to view the employees' attendance results. Also, you can pre-define the report content and it can send the report automatically to you via email. For more details, refer to [\*\*\*Generate Instant Report\*\*\*](#) and [\*\*\*Send Report Regularly\*\*\*](#) .

## 16.2 Configure Attendance Parameters

You can configure the attendance parameters, including the general rule, overtime parameters, attendance check point, holiday, leave type, etc.

### 16.2.1 Set Weekend

The days of weekends may vary in different countries and regions. The client provides weekends definition function. You can select one or more days as the weekends according to actual requirements, and set different attendance rules for weekends from workdays.

## Steps

---

### Note

The parameters configured here will be set as default for the newly added time period. It will not affect the existed one(s).

---

1. Enter Time & Attendance module.
2. Click **Attendance Settings → General Rule** .
3. Select the day(s) as weekend, such as Saturday and Sunday.
4. Click **Save**.

## 16.2.2 Object Missing

This object is not available in the repository.

## 16.2.3 Configure Overtime Parameters

You can configure the overtime parameters for workday and weekend, including overtime level, work hour rate, attendance status for overtime, etc.

### Steps

1. Click **Time & Attendance → Attendance Settings → Overtime** .
2. Set required information.

#### **Overtime Level for Workday**

When you work for a certain period after end-work time on workday, you will reach different overtime level: overtime level 1, overtime level 2 and overtime level 3. You can set different work hour rate for three overtime levels, respectively.

#### **Work Hour Rate**

Work Hour Rate is used to calculate work hours by multiplying it by overtime. When you work for a certain period after end-work time on workday, you will reach different overtime level. You can set different work hour rates (1-10, can be a decimal) for three overtime levels. For example, your valid overtime is one hour (in overtime level 1), and the work hour rate of overtime level 1 is set as 2, then the work hours in the period will be calculated as 2 hours.

#### **Overtime Rule for Weekend**

You can enable overtime rule for weekend and set calculation mode.

3. Click **Save**.

## 16.2.4 Configure Attendance Check Point

You can set the card reader(s) of the access control device as the attendance check point(s), so that the authentication on the card readers will be recorded for attendance.

## Before You Start

- You have added access control device(s). For details, refer to ***Add Device*** .
- You have enabled T&A Status. For details, refer to ***Add General Timetable*** .

By default, all card readers of the added access control devices are set as start/end-work check points. If you need to edit check point function of card reader(s), you can perform the following operations.

## Steps

1. Enter the Time & Attendance module.
2. Click **Attendance Settings** → **Attendance Check Point** to enter the attendance check point settings page.
3. Set **Set All Card Readers as Check Points** switch to off.
4. Check the desired card reader(s) as attendance check point(s) in the list below.
5. Set check point function as **Start/End-Work**, **Start-Work** or **End-Work**.



## Note

When selecting **Start-Work** or **End-Work**, the attendance status uploaded from the device will be decided by the check point function you set here.

---

## Start-Work

Attendance status uploaded from the device will all be calculated as Check-in.

## End-Work

Attendance status uploaded from the device will all be calculated as Check-out.

## Start/End-Work

Attendance status will be calculated as Check in/out according to the actual attendance status on the device.

6. Click **Set as Check Point**.

The configured attendance check point(s) are displayed on the right list.

7. **Optional:** After setting attendance check points, and perform the following operations.

**Edit Check Point**      Check one attendance check point, click **Edit** to edit its information including name, check point function, etc.

Check two or more attendance check points, click **Edit** to batch edit check point function, enter remark, etc.

**Delete Check Point**      Check one or more check points, and click **Delete** to delete it/them.

## 16.2.5 Configure Holiday

You can add the holiday during which the check-in or check-out will not be recorded.

## Add Regular Holiday

You can configure a holiday which will take effect annually on regular days during the effective period, such as New Year's Day, Independence Day, Christmas Day, etc.

### Steps

1. Enter the Time & Attendance module.
2. Click **Attendance Settings** → **Holiday** to enter the Holiday Settings page.
3. Check **Regular Holiday** as holiday type.
4. Custom a name for the holiday.
5. Set the first day of the holiday.
6. Enter the number of the holiday days.
7. Set the attendance status if the employee works on holiday.
8. **Optional:** Check **Repeat Annually** to make this holiday setting effective every year.
9. Click **OK**.

The added holiday will display in the holiday list and calendar.

If the date is selected as different holidays, it will be recorded as the first-added holiday.

10. **Optional:** After adding the holiday, perform one of the following operations.

**Edit Holiday** Click  to edit the holiday information.

**Delete Holiday** Select one or more added holidays, and click **Delete** to delete the holiday(s) from the holiday list.

## Add Irregular Holiday

You can configure a holiday which will take effect annually on irregular days during the effective period, such as Bank Holiday.

### Steps

1. Enter the Time & Attendance module.
2. Click **Attendance Settings** → **Holiday** to enter the Holiday Settings page.
3. Click **Add** to open the Add Holiday page.
4. Check **Irregular Holiday** as holiday type.
5. Custom a name for the holiday.
6. Set the start date of the holiday.

### Example

If you want to set the fourth Thursday in November, 2019 as the Thanksgiving Day holiday, you should select 2019, November, 4th, and Thursday from the four drop-down lists.

7. Enter the number of the holiday days.
8. Set the attendance status if the employee works on holiday.
9. **Optional:** Check **Repeat Annually** to make this holiday setting effective every year



**10.** Click **OK**.

The added holiday will display in the holiday list and calendar.

If the date is selected as different holidays, it will be recorded as the first-added holiday.

**11. Optional:** After adding the holiday, perform one of the following operations.

**Edit Holiday** Click  to edit the holiday information.

**Delete Holiday** Select one or more added holidays, and click **Delete** to delete the holiday(s) from the holiday list.

### 16.2.6 Configure Leave Type

You can customize the leave type (major leave type and minor leave type) according to actual needs. You can also edit or delete the leave type.

#### Steps

**1.** Enter the Time & Attendance module.

**2.** Click **Attendance Settings** → **Leave Type** to enter the Leave Type Settings page.

**3.** Click **Add** on the left to add a major leave type.

**4. Optional:** Perform one of the following operations for major leave type.

**Edit** Move the cursor over the major leave type and click  to edit the major leave type.

**Delete** Select one major leave type and click **Delete** on the left to delete the major leave type.

**5.** Click **Add** on the right to add a minor leave type.

**6. Optional:** Perform one of the following operations for minor leave type.

**Edit** Move the cursor over the minor leave type and click  to edit the minor leave type.

**Delete** Select one or multiple major leave types and click **Delete** on the right to delete the selected minor leave type(s).

### 16.2.7 Synchronize Authentication Record to Third-Party Database

The attendance data recorded on the client can be used by other system for calculation or some other operations. You can enable synchronization function to apply the authentication record from the client to the third-party database automatically.

#### Steps

**1.** Enter Time & Attendance module.

**2.** Click **Attendance Settings** → **Third-Party Database** .

**3.** Set **Apply to Database** switch to on to enable synchronization function.

**4.** Select database Type as **SQLServer** or **MySQL**.

---

### Note

- Supported versions : SQLServer 2008, MySQL V5.7.26.
  - You should set the field type of the database type as varchar.
  - If you select **MySQL**, you should import the configuration file (libmysql.dll) from local PC.
5. Set the other required parameters of the third-party database, including server IP address, port No., database name, user name and password.
- 

### Note

The default port No. of the selected database type is displayed automatically. You can enter a number ranging from 1 to 65535 to customize the port No if needed.

---

6. Set table parameters of database according to the actual configuration.
- 1) Enter the table name of the third-party database.
  - 2) Set the mapped table fields between the client and the third-party database.
7. Click **Save** to test whether database can be connected and save the settings for the successful connection.
- The attendance data will be written to the third-party database.
  - During synchronization, if the client disconnects with the third-party database, the client will start reconnection every 30 mins. After being reconnected, the client will synchronize the data recorded during the disconnected time period to the third-party database.

### 16.2.8 Configure Attendance Calculation Accuracy

To calculate the attendance data accurately, you can set the attendance calculation accuracy for different attendance items, including the minimum unit for attendance calculation and round-off control rule. For example, you can set the minimum unit as 1 hour for leave duration, and set the round-off control rule as round up.

#### Steps

1. Enter the Time and Attendance module.
2. Click **Attendance Settings → General Rule** .
3. In the Advanced Function area, set the minimum units (including min, Hour(s) and Workday) for different statistic items.
4. Set the round-off control rules (including Round Down, Round Off and Round Up) for different statistic items.
5. Set the **Display Format** as **MM** or **HH:MM**.
6. Click **Save**.

#### Example

Set the minimum unit as 1 hour and the round-off control rule as round down for overtime duration, and if the overtime duration is less than 1 hour, it will be calculated as 0. If the overtime duration is 1.5 hour, it will be calculated as 1 hour.

## 16.2.9 Configure Break Time

You can add break time and set start time, end time, duration, calculation mode and other parameters for the break. The added break time can also be edited or deleted.

### Steps

1. Click **Time & Attendance → Timetable → Break Time** .

The added break time is displayed in the list.

2. Click **Break Time Settings** to enter Break Time Settings window.
3. Click **Add**.
4. Enter a name for the break time.
5. Set related parameters for the break time.

### Start Time / End Time

Set the time when the break starts and ends.

### No Earlier Than / No Later Than

Set the earliest swiping time for starting break and the latest swiping time for ending break.

### Break Duration

The duration from start time to end time of the break.

### Calculation

#### Auto Deduct

The break duration will be calculated according to the time you set.

#### Must Check

The break duration will be calculated and excluded from work hours according to actual check-in and check-out time.

#### Return from Break Early for

The actual check-in and check-out time does not exceed the break time, and can be marked as normal work or work overtime.

#### Return from Break Late for

The actual check-in and check-out time exceeds the break time, and can be marked as late, absent or early leave.

#### Calculated by

**Each Check in/out:** Each check-in time and check-out time is valid and the sum of all periods between adjacent check-in and check-out time will be recorded as the break time duration.

**First In & Last Out:** The first check-in time is recorded as start break time and the last check-out time is recorded as the end break time.

#### Enable T&A Status

Set **Enable T&A Status** switch to on to calculate the actual break time according to attendance status on the device.

---

 **Note**

This function should be supported by the device.

---

### **Valid Authentication Interval**

During the valid authentication interval, person swiping card for several times will only be calculated as once when calculating attendance data.

6. Click **Save** to save the settings.
7. **Optional:** Click **Add** to continue adding break time.

## **16.3 Add Flexible Timetable**

On the timetable page, you can add flexible timetable for employees, which does not requires the check-in/out time but requires the staffs' working time (from the start time you set) is equal or greater than the predefined work hours.

### **Steps**

1. Click **Time and Attendance → Timetable** to enter the timetable settings page.
2. Click **Add** to enter add timetable page.
3. Create a name for the timetable.

---

 **Note**

You can click the color icon beside the name to customize the color for the valid timetable on the time bar.

---

4. Select the timetable type as flexible.

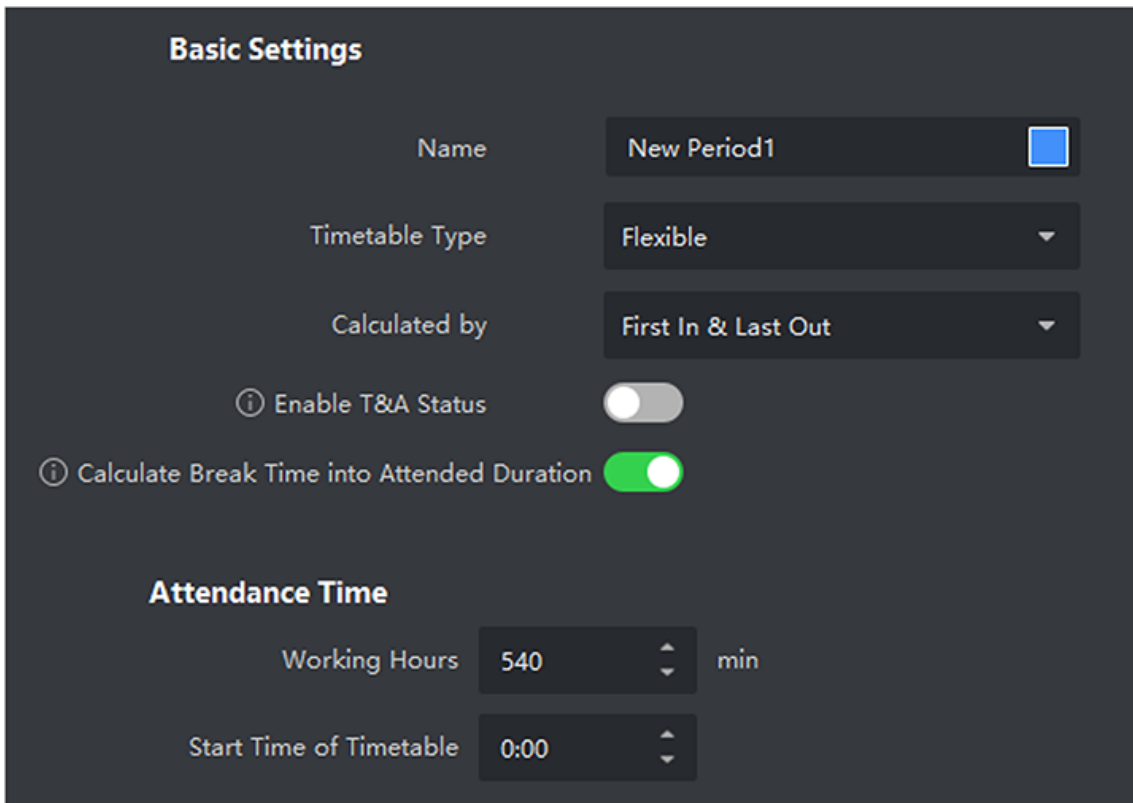

**Basic Settings**

Name: New Period1

Timetable Type: Flexible

Calculated by: First In & Last Out

Enable T&A Status:

Calculate Break Time into Attended Duration:

**Attendance Time**

Working Hours: 540 min

Start Time of Timetable: 0:00

Figure 16-2 Add Flexible Timetable

5. Select calculation method.

#### First In & Last Out

The first check-in time is recorded as start work time and the last check-out time is recorded as the end-work time.

#### Each Check-In/Out

Each check-in time and check-out time is valid and the sum of all periods between adjacent check-in and check-out time will be recorded as the valid working duration.

You need to set **Valid Authentication Interval** for this calculation method. For example, if the interval between card swiping of the same card is less than the set value, the card swiping is invalid.

6. **Optional:** Enable **Enable T&A Status** to calculate according to attendance status of the device.

---

#### Note

This function should be supported by the device.

7. **Optional:** Enable **Calculate Break Time into Attended Duration**.

---

### **Note**

When enabled, break time will be calculated into the overall attendance duration. That is, the actual attendance duration equals to the overall attendance duration (includes break time).

---

8. Set the related attendance time parameters as the following:

#### **Working Hours**

The employees' working hours should be equal or greater than the set value.

#### **Start Time of Timetable**

Calculate the working hours of each day from the set value.

For example, if you have set the working hours as 8 hours, and the start time of timetable as 9:00 am, and the staff A checked-in at 8:00 am and checked-out at 5:00 pm (effective working hours are 9:00 am to 5:00 pm, totally 8 hours), the attendance result for staff A will be calculated as normal.

9. Click **Save** to add the timetable.

10. **Optional:** Perform one or more following operations after adding timetable.

**Edit Timetable**      Select a timetable from the list to edit related information.

**Delete Timetable**      Select a timetable from the list and click **Delete** to delete it.

## 16.4 Add General Timetable

On the timetable page, you can add general timetable for employees, which requires the fixed start-work time and end-work time. Also, you can set valid check-in/out time, allowable timetable for being late and leaving early.

### **Steps**

1. Click **Time and Attendance** → **Timetable** to enter the timetable settings page.
2. Click **Add** to enter add timetable page.

The screenshot shows a configuration window with two main sections: 'Basic Settings' and 'Attendance Time'. In 'Basic Settings', there is a 'Name' field with 'Default Timetable' and a blue square icon, a 'Timetable Type' dropdown set to 'General', a 'Calculated by' dropdown set to 'Each Check-In/Out', a 'Valid Authentication Interval' spinner set to '1' min, and three toggle switches: 'Enable T&A Status' (checked), 'Calculate Break Time into Atte...' (checked), and 'Count Early Check-In as Overti...' (unchecked). The 'Attendance Time' section includes 'Start-Work Time' (8:00), 'End-Work Time' (18:00), 'Valid Check-In Time' (1:30 to 10:30), 'Valid Check-Out Time' (13:30 to 23:30), 'Calculated as' (600 min), 'Late Allowable' (10 min), and 'Early Leave Allowable' (10 min). A red 'Save' button is at the bottom.

Figure 16-3 Add Timetable

3. Create a name for the timetable.

---

 **Note**

You can click the color icon beside the name to customize the color for the valid timetable on the time bar in the Configuration Result area.

4. Select the timetable type as general.
5. Select calculation method.

**First In & Last Out**

The first check-in time is recorded as start work time and the last check-out time is recorded as the end-work time.

**Each Check-In/Out**

Each check-in time and check-out time is valid and the sum of all periods between adjacent check-in and check-out time will be recorded as the valid working duration.

You need to set **Valid Authentication Interval** for this calculation method. For example, if the interval between card swiping of the same card is less than the set value, the card swiping is invalid.

- 6. Optional:** Set **Enable T&A Status** switch to on to calculate according to attendance status of the device.
- 

 **Note**

This function should be supported by the device.

---

- 7. Optional:** Enable **Calculate Break Time into Attended Duration**.
- 

 **Note**

When enabled, break time will be calculated into the overall attendance duration. That is, the actual attendance duration equals to the overall attendance duration (includes break time).

---

- 8. Optional:** Enable **Count Early Check-In as Overtime**, then the period between your early check-in and the official start-work time will be calculated as overtime.
- 9.** Set the related attendance time parameters as the following:

**Start/End-Work Time**

Set the start-work time and end-work-time.

**Valid Check-in/out Time**

On the time bar, adjust the yellow bar to set the timetable during which the check-in or check-out is valid.

**Calculated as**

Set the duration calculated as the actual work duration.

**Late/Early Leave Allowable**

Set the timetable for late or early leave.

- 10.** Set absence related parameters.

**Check-In, Late for**

You can set the late time duration for the employee who has checked in but is late for work. If the employee exceeds the required time period, his/her attendance data will be marked as absent.

**Check-Out, Early Leave for**

You can set the early leave time duration for the employee who checks out earlier than the normal leave time, and his/her attendance data will be marked as absent.

**No Check-in**

If the employee does not check in, his/her attendance data may be marked as absent or late.

**No Check-Out**

If the employee does not check out, his/her attendance data may be marked as absent or early leave.



11. Click **Save** to add the timetable.

12. **Optional:** Perform one or more following operations after adding timetable.

**Edit Timetable**      Select a timetable from the list to edit related information.

**Delete Timetable**      Select a timetable from the list and click **Delete** to delete it.

### 16.5 Add Shift

You can add shift for employees including setting shift period (day, week, month) and the effective attendance time. According to the actual requirements, you can adding multiple timetables in one shift for employees, which requires them to check in and check out for each timetable.

#### Before You Start

Add a timetable first. See [\*\*\*Add General Timetable\*\*\*](#) for details.

#### Steps

1. Click **Time & Attendance** → **Shift** to enter shift settings page.
2. Click **Add** to enter Add Shift page.
3. Enter the name for shift.
4. Select the shift period from the drop-down list.
5. Select the added timetable and click on the time bar to apply the timetable.

**Shift**

Name: Default Shift

Period: 1 Week(s)

**Timetable 1**

× Delete 🗑️ Clear

Timetable 1 : 09:00 - 18:00

Time	00:00	02:00	04:00	06:00	08:00	10:00	12:00	14:00	16:00	18:00	20:00	22:00	24:00
Mon.						█	█	█	█	█			
Tue.						█	█	█	█	█			
Wed.						█	█	█	█	█			
Thu.						█	█	█	█	█			
Fri.						█	█	█	█	█			
Sat.						█	█	█	█	█			
Sun.						█	█	█	█	█			

**Save** **Assign**

Figure 16-4 Add Shift

 **Note**

You can select more than one timetables. The start and end work time and the valid check-in and out time in different time tables can not be overlapped.

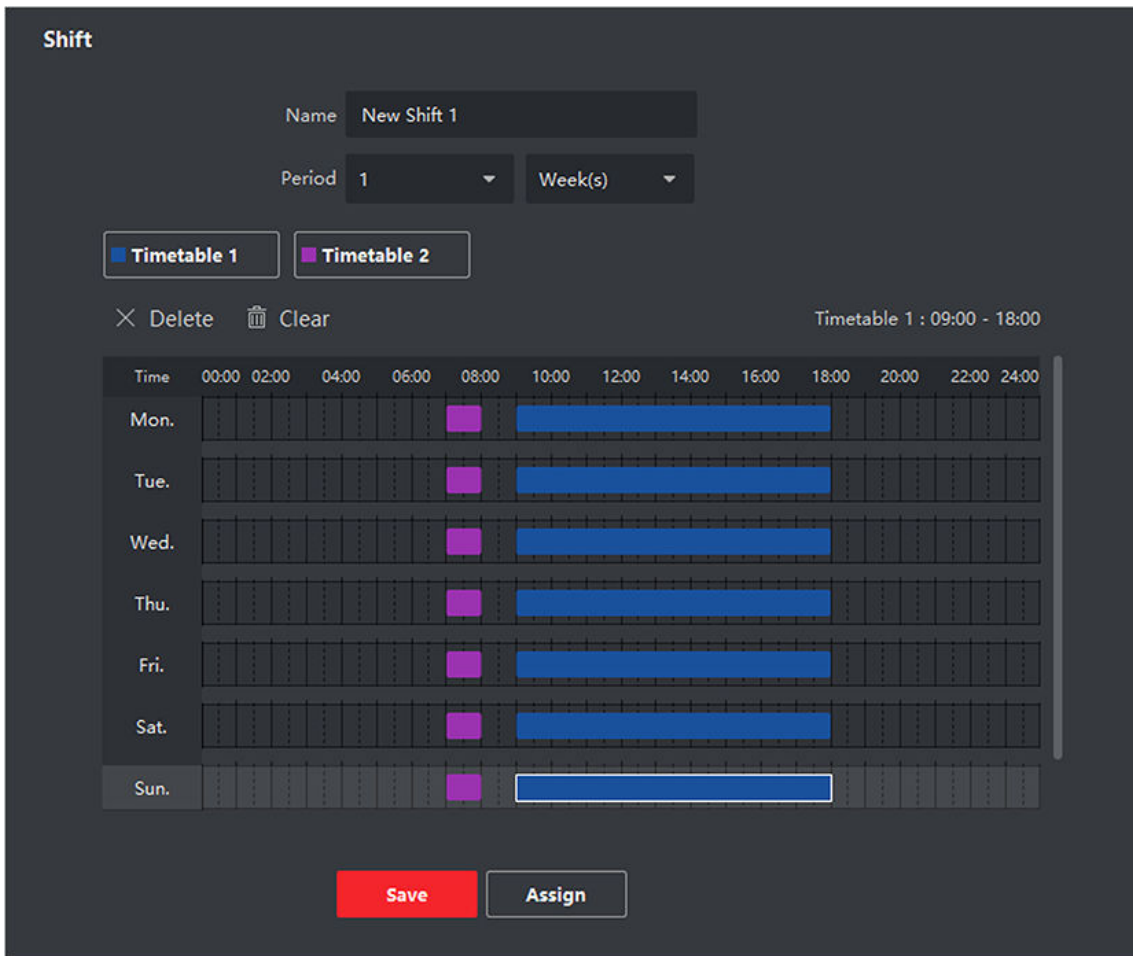

Figure 16-5 Add Multiple Timetables

6. Click **Save**.

The added shift lists on the left panel of the page. At most 64 shifts can be added.

7. **Optional:** Assign the shift to organization or person for a quick shift schedule.

1) Click **Assign**.

2) Select **Organization** or **Person** tab and check the desired organization(s) or person(s) box.

The selected organizations or persons will list on the right page.

3) Set the Expire Date for the shift schedule.

4) Set other parameters for the schedule.

**Check-in Not Required**

Persons in this schedule do not need to check-in when they come to work.

**Check-out Not Required**

Persons in this schedule do not need to check-out when they end work.

**Scheduled on Holidays**

On the holidays, this schedule is still effective and the persons needs to go to work according to the schedule.

### **Effective for Overtime**

The persons' overtime will be recorded for this schedule.

5) Click **Save** to save the quick shift schedule.

## 16.6 Manage Shift Schedule

Shift work is an employment practice designed to make use of all 24 hours of the clock each day of the week. The practice typically sees the day divided into shifts, set periods of time during which different shifts perform their duties.

You can set department schedule, person schedule, and temporary schedule.

### 16.6.1 Set Department Schedule

You can set the shift schedule for one department, and all the persons in the department will be assigned with the shift schedule.

#### **Before You Start**

In Time & Attendance module, the department list is the same with the organization. You should add organization and persons in Person module first. See ***Person Management*** for details.

#### **Steps**

1. Click **Time & Attendance → Shift Schedule** to enter the Shift Schedule Management page.
2. Click **Department Schedule** to enter Department Schedule page.
3. Select the department from the organization list on the left.



#### **Note**

If **Include Sub Organization** is checked, when selecting the organization, its sub organizations are selected at the same time.

4. Select the shift from the drop-down list.
5. **Optional:** Enable **Multiple Shift Schedules** and select the effective time period(s) from the added timetables for the persons.



#### **Note**

This is only available for shift with only one timetable.

#### **Multiple Shift Schedules**

It contains more than one timetables. The person can check in/out in any of the timetables and the attendance will be effective.

If the multiple shift schedules contains three timetables: 00:00 to 07:00, 08:00 to 15:00 and 16:00 to 23:00. The attendance of the person adopting this multiple shift schedules will be effective in any of the three timetables. If the person checks in at 07:50, it will apply the nearest timetable 08:00 to 15:00 to the person's attendance.

---

6. Set the start date and end date.
7. Set other parameters for the schedule.

### **Check-in Not Required**

Persons in this schedule do not need to check-in when they come to work.

### **Check-out Not Required**

Persons in this schedule do not need to check-out when they end work.

### **Scheduled on Holidays**

On the holidays, this schedule is still effective and the persons needs to go to work according to the schedule.

### **Effective for Overtime**

The persons' overtime will be recorded for this schedule.

### **Flexible Shift Schedule on Weekend**

The person's attendance on the weekend will be recorded as overtime.

8. Click **Save**.

## **16.6.2 Set Person Schedule**

You can assign the shift schedule to one or more persons. You can also view and edit the person schedule details.

### **Before You Start**

Add department and person in Person module. See [\*\*\*Person Management\*\*\*](#) for details.

### **Steps**

---



The person schedule has the higher priority than department schedule.

---

1. Click **Time & Attendance → Shift Schedule** to enter the Shift Schedule page.
2. Click **Person Schedule** to enter Person Schedule page.
3. Select the organization and select the person(s).
4. Select the shift from the drop-down list.
5. **Optional:** Enable **Multiple Shift Schedules** and select the effective time period(s) from the added timetables for the persons.

---

 **Note**

This is only available for shift with only one timetable.

### **Multiple Shift Schedules**

It contains more than one timetables. The person can check in/out in any of the timetables and the attendance will be effective.

If the multiple shift schedules contains three timetables: 00:00 to 07:00, 08:00 to 15:00 and 16:00 to 23:00. The attendance of the person adopting this multiple shift schedules will be effective in any of the three timetables. If the person checks in at 07:50, it will apply the nearest timetable 08:00 to 15:00 to the person's attendance.

---

6. Set the start date and end date.
7. Set other parameters for the schedule.

### **Check-in Not Required**

Persons in this schedule do not need to check-in when they come to work.

### **Check-out Not Required**

Persons in this schedule do not need to check-out when they end work.

### **Scheduled on Holidays**

On the holidays, this schedule is still effective and the persons needs to go to work according to the schedule.

### **Effective for Overtime**

The persons' overtime will be recorded for this schedule.

### **Flexible Shift Schedule on Weekend**

The person's attendance on the weekend will be recorded as overtime.

8. Click **Save**.

## **16.6.3 Set Temporary Schedule**

You can add a temporary schedule for the person and the person will be assigned with the shift schedule temporarily. You can also view and edit the temporary schedule details.

### **Before You Start**

Add department and person in Person module. See [\*\*\*Person Management\*\*\*](#) for details.

### **Steps**

---

 **Note**

The temporary schedule has higher priority than department schedule and person schedule.

---

1. Click **Time & Attendance → Shift Schedule** to enter the Shift Schedule Management page.
2. Click **Temporary Schedule** to enter Temporary Schedule page.
3. Select the organization and select the person(s).

4. Click one date or click and drag to select multiple dates for the temporary schedule.
5. Select **Workday** or **Non-Workday** from drop-down list.

If **Non-Workday** is selected, you need to set the following parameters.

### Calculated as

Select normal or overtime level to mark the attendance status for temporary schedule.

### Timetable

Select a timetable from drop-down list.

### Multiple Shift Schedule

It contains more than one timetables. The person can check in/out in any of the timetables and the attendance will be effective.

If the multiple shift schedules contains three timetables: 00:00 to 07:00, 08:00 to 15:00 and 16:00 to 23:00. The attendance of the person adopting this multiple shift schedules will be effective in any of the three timetables. If the person checks in at 07:50, it will apply the nearest timetable 08:00 to 15:00 to the person's attendance.

### Rule



Set other rule for the schedule, such as **Check-in Not Required**, and **Check-out Not Required**.

6. Click **Save**.

## 16.6.4 Check Shift Schedule

You can check the shift schedule in calendar or list mode. You can also edit or delete the shift schedule.

### Steps

1. Click **Time & Attendance** → **Shift Schedule** to enter the Shift Schedule Management page.
2. Select the organization and corresponding person(s).
3. Click  or  to view the shift schedule in calendar or list mode.

### Calendar

In calendar mode, you can view the shift schedule for each day in one month. You can click the temporary schedule for one day to edit or delete it.

### List

In list mode, you can view the shift schedule details about one person or organization, such as shift name, type, effective period and so on. Check the shift schedule(s), and click **Delete** to delete the selected shift schedule(s).

## 16.7 Manually Correct Check-in/out Record

If the attendance status is not correct, you can manually correct the check-in or check out record. You can also edit, delete, and export the check-in or check-out record.

## Before You Start

- You should add organizations and persons in Person module. For details, refer to **Person Management**.
- The person's attendance status is incorrect.



## Steps

1. Click **Time & Attendance** → **Attendance Handling** to enter attendance handling page.
2. Click **Correct Check-in/out** to enter adding check-in/out correction page.
3. Select one or more persons from left list for correction.
4. Select the correction date.
5. Select the correction type as **Check-in, Check-out, Break-in, Break-out**, etc., and set the correct time.

---

### Note

You can click  to add multiple correction items. At most 8 check-in/out items can be added.

6. **Optional:** Enter the remark information as desired.
7. Click **Save** to save the above settings.
8. **Optional:** After adding the check-in/out correction, perform one of the following operations.
  - View** Click  or  to view the added attendance handling information in calendar or list mode.
  - Edit**
    - In calendar mode, click  → **Edit** to edit the details.
    - In list mode, double-click the related field in Date, Handling Type, Time, or Remark column to edit the details.

---

### Note

The edited check-in/out correction will take affect.

- Delete**
  - In calendar mode, select one check-in/out correction, and click **Delete** to delete the selected item.
  - In list mode, check one or more check-in/out corrections, and click **Delete** to delete the selected items.

---

### Note

The deleted check-in/out correction will no longer take affect.

- Export** In list mode, check one or more check-in/out corrections to export the attendance handling details (CSV file) to local PC.

## 16.8 Add Leave and Business Trip

You can add leave and business trip when the employee want to ask for leave or go on a business trip.



### Before You Start

You should add organizations and persons in the Person module. For details, refer to [\*\*\*Person Management\*\*\*](#).

### Steps



1. Click **Time & Attendance** → **Attendance Handling** to enter attendance handling page.
2. Click **Apply for Leave/Business Trip** to enter adding the leave/business trip page.
3. Select person from left list.
4. Set the date(s) for your leave or business trip.
5. Select the major leave type and minor leave type from the drop-down list.

---

#### **Note**

You can set the leave type in Attendance Settings. For details, refer to [\*\*\*Configure Leave Type\*\*\*](#).

6. Set the time for leave.
7. **Optional:** Enter the remark information as desired.
8. Click **Save**.
9. **Optional:** After adding the leave and business trip, perform one of the following operations.

**View** Click  or  to view the added attendance handling information in calendar or list mode.

---

#### **Note**

In calendar mode, you need to click **Calculate** to get the attendance status of the person in one month.

**Edit**

- In calendar mode, click the related label on date to edit the details.
- In list mode, double-click the field in Date, Handling Type, Time, or Remark column to edit the related information.

**Delete** Delete the selected items.

**Export** Export the attendance handling details to local PC.

---

#### **Note**

The exported details are saved in CSV format.

---

## 16.9 Calculate Attendance Data

You need to calculate the attendance data before searching and viewing the overview of the attendance data, employees' detailed attendance data, employees' abnormal attendance data, the employees' overtime working data, and card swiping log.

### 16.9.1 Automatically Calculate Attendance Data

You can set a schedule so that the client can automatically calculate attendance data of the previous day at the time you configured every day.

#### Steps



1. Enter the Time & Attendance module.
2. Click **Attendance Settings → General Rule** .
3. In the Auto-Calculate Attendance area, set the time that you want the client to calculate the data.
4. Click **Save**.

The client will calculate the attendance data of the previous day from the time you have configured.

### 16.9.2 Manually Calculate Attendance Data

You can manually calculate attendance data by setting conditions including attendance time, department, attendance status, etc.

#### Steps

1. Enter the Time & Attendance module.
2. Click **Attendance Statistics → Calculation** .
3. Set the start time and end time to define the attendance data range.
4. Select the department from the drop-down list.
5. **Optional:** Set other conditions, including name and person ID.
6. Check attendance status (supports multi-selection).
7. Click **Calculate**.



Only the attendance data within three months can be calculated.

8. **Optional:** Perform one of the following operations.

<b>Correct Check-in/out</b>	Select one person, click <b>Correct Check-in/out</b> to add check-in/out correction.
<b>Select Items to Display</b>	Click  on the upper right corner, or right click the table header of the attendance data list to customize the items to be displayed in the list.
<b>Adjust Items Sequence</b>	Click one item (except Person ID) and move the mouse to customize the sequence of different items.
<b>Generate Report</b>	Click <b>Report</b> to generate the attendance report.



The report items will be displayed in the sequence you have set.

---

## **Export Report**

Click **Export** to export attendance data (CSV file) to local PC.

---



The report items will be displayed in the sequence you have set.

---

## **16.10 Attendance Statistics**

You can check the original attendance record, generate and export the attendance report based on the calculated attendance data.

### **16.10.1 Get an Overview of Employees' Attendance Data**

You can search and view the employee's attendance data on the client, including attendance time, attendance status, check point, etc.

#### **Before You Start**

- You should add organizations and persons in Person module and the persons have swiped cards. For details, refer to ***Person Management*** .
  - Calculate the attendance data.
- 



- The client will automatically calculate the previous day's attendance data at 1:00 am on the next day.
  - Keep the client running at 1:00 am or it cannot calculate the previous day's attendance data automatically. If not calculated automatically, you can calculate the attendance data manually. For details, refer to ***Manually Calculate Attendance Data*** .
- 

#### **Steps**

- 1.** Enter the Time & Attendance module.
  - 2.** Click **Attendance Statistics** → **Attendance Record** .
  - 3.** Set the attendance start time and end time that you want to search.
  - 4.** Set other search conditions, including department, name, and person ID.
  - 5.** Select data source as **All**, **Original Records on Device** or **Manually Handled Records**.
  - 6. Optional:** Click **Get Events from Device** to get the attendance data from the device.
- 



There are two methods for getting attendance events from the device, including **Online** and **Import File**. For more details about operations, refer to ***Get Events from Device*** .

---

**7. Optional:** Click **Reset** to reset all the search conditions and edit the search conditions again.

**8.** Click **Search**.

**9. Optional:** For the displayed search results, perform one of the following operations.

- |                               |  |
|-------------------------------|--|
| <b>Edit Attendance Status</b> | Select one incorrect record, double click the field of <b>Attendance Status</b> column and select from the drop-down list to edit single piece of attendance status.<br><br>Check two or more incorrect records, click <b>Edit Attendance Status</b> on the upper left corner and select from the drop-down list to batch edit multiple pieces of attendance status. |
| <b>Generate Report</b>        | Click <b>Report</b> to generate the attendance report.   |
| <b>Export Report</b>          | Click <b>Export</b> and select saving path to export the attendance report (CVS file) to the local PC.   |
| <b>Custom Export</b>          | Click <b>Custom Report</b> and set conditions to export attendance records according to actual needs. For details, refer to <u><b>Custom Export Attendance Records</b></u> .   |

### 16.10.2 Custom Export Attendance Records

After viewing the employee's attendance data, you can export the attendance records according to actual needs.

Before exporting the necessary attendance records, you should search and get employee's attendance data. For details, refer to **Get an Overview of Employees' Attendance Data** .

Click **Custom Export** to set the related information.

#### **Start/End Time**

You can set the start and end time of exporting attendance records.

#### **Saving Path**

You can select the file path for saving attendance records.

#### **File Name**

The file will be named according to the actual exporting date. You can select format of the date such as **dd-MM-yyyy** and **dd-MM-yy**.

#### **Format**

You can export the original attendance records in .TXT and .CVS formats.

#### **Separator**

You can select to have/not have separators (including comma, space, tab) for separating different items in the exported file.

#### **Export**

You can select the items you need to export including ID, person name, department, date, etc.

### Default Value

When there is no information for the item you have selected to export, you can set a default value to replace the blank space.

### 16.10.3 Configure Report Display

You can configure display contents displayed in the attendance report, such as the company name, logo, date format, time format, and mark.

#### Steps

1. Enter Time & Attendance module.
2. Click **Attendance Statistics → Report Display** .
3. Set the display settings for attendance report.

#### Company Name

Enter a company name to display the name in the report.

#### Attendance Status Mark

Enter the mark and select the color. The related fields of attendance status in the report will display with the mark and color.

#### Weekend Mark

Enter the mark and select the color. The weekend fields in the report will display with the mark and color.

4. Click **Save**.

### 16.10.4 Generate Instant Report

It supports to generate the a series of attendance reports manually to view the employees' attendance results.

#### Before You Start

Calculate the attendance data.



#### Note

You can calculate the attendance data manually, or set the schedule so that the client can calculate the data automatically every day. For details, refer to ***Calculate Attendance Data*** .

---

#### Steps

1. Enter the Time & Attendance module.
2. Click **Attendance Statistics → Report** .
3. Select a report type.
4. Select the department or person to view the attendance report.
5. Set the start time and end time during which the attendance data will be displayed in the report.

6. Click **Report** to generate the statistics report and open it.

### 16.10.5 Send Report Regularly

The client supports multiple report types and you can pre-define the report content and it can send the report automatically to the email address you configured.

#### Steps

1. Enter the Time & Attendance module.
2. Click **Attendance Statistics** → **Regularly Send Report** .
3. Click **Add** to enter the add custom report page.
4. Set the report content.

#### Report Name

Enter a name for the report.

#### Report Type

Select one report type and this report will be generated.

#### Report Time

The time to be selected may vary for different report type.

#### Person

Select the added person(s) whose attendance records will be generated for the report.



You can view the selected person(s) in the right side of the Person area.

5. Set the schedule to send the report to the email address(es) automatically.



The **Auto-Send Email** function is enabled by default.

- 1) Set the Effective Period during which the client will send the report on the selected sending date(s).
- 2) Select the Sending Date(s) on which the client will send the report.
- 3) Set the Sending Time at which the client will send the report.

#### Example

If you set the effective period as **2018/3/10 to 2018/4/10**, select **Friday** as the sending date, and set the sending time as **20:00:00**, the client will send the report at 8 p.m. on Fridays during 2018/3/10 to 2018/4/10.

---

 **Note**

Make sure the attendance records are calculated before the sending time. You can calculate the attendance data manually, or set the schedule so that the client can calculate the data automatically every day. For details, refer to ***Calculate Attendance Data*** .

---

4) Enter the receiver email address(es).

---

 **Note**

Up to 5 email addresses can be added. You can click + to add a new email address.

---

5) **Optional:** Click **Preview** to view the email details.

6. Click **OK**.

7. **Optional:** After adding the custom report, you can do one or more of the followings:

**Edit Report**      Select one added report and click **Edit** to edit its settings.

**Delete Report**      Select one added report and click **Delete** to delete it.

**Generate Report**      Select one added report and click **Report** to generate the report instantly and you can view the report details.

## Chapter 17 Video Intercom

Video intercom is an audiovisual communication system used within a building or a small collection of buildings. With microphones and video camera devices at both sides, it enables the inter-communication via video and audio signals. A video intercom system can provide a safe and easy monitoring solution for apartment buildings and private houses.

Be sure to add video intercom devices to the client and link the indoor stations to the persons beforehand. You should also set the access authorization for the persons to open doors via the linked indoor stations.

### Note

- For details about adding persons, refer to [Add Single Person](#) .
- For details about setting person's access authorization, refer to [Set Access Group to Assign Access Authorization to Persons](#) .

### 17.1 Flow Chart

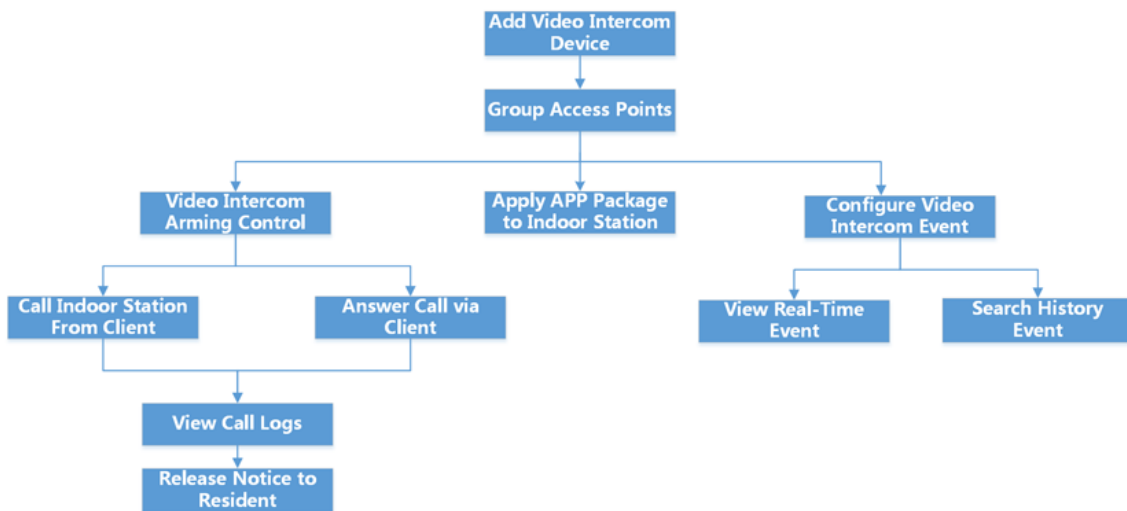

Figure 17-1 Flow Chart of Video Intercom

- **Add Video Intercom Device:** You can add video intercom devices on the client. For more details, refer to [Add Device](#) .
- **Group Access Points:** You can group the added access points into groups for convenient management. For more details, refer to [Group Management](#) .



- **Video Intercom Arming Control:** You can enable or disable the calling between the added video intercom devices and the client. For more details, refer to [\*\*Enable Calling between Video Intercom Device and Client\*\*](#) .
- **Apply APP Package to Indoor Station:** You can apply the application package saved in local PC to one or multiple indoor stations remotely via the client. For more details, refer to [\*\*Object Missing\*\*](#) .
- **Call Indoor Station From Client:** You can call the added indoor station by the client to perform video intercom. For more details, refer to [\*\*Call Indoor Station from Client\*\*](#) .
- **Answer Call via Client:** You can answer call from the added indoor station, door station, etc. via the client to perform video intercom. For more details, refer to [\*\*Answer Call via Client\*\*](#) .
- **View Call Logs:** You can view details of all the calls. For more details, refer to [\*\*View Real-Time Call Logs\*\*](#) .
- **Release Notice to Resident:** You can send a notice to the residents by one-touch on the client. For more details, refer to [\*\*Release a Notice to Resident\*\*](#) .
- **Configure Video Intercom Event:** By configuring linked actions of video intercom event on the client, you will be notified once the event is triggered. For more details, refer to [\*\*Configure Video Intercom Event\*\*](#) .
- **Search Real-Time/History Event:** You can view the real-time events, search the historical events on the client. For more details, refer to [\*\*Event Center\*\*](#) .

## 17.2 Manage Calls between Client Software and an Indoor/Door Station/Access Control Device

You can call the residents by the client, and vice versa. You can also use an indoor station/door station or specified access control device to call the client.

Before making calls, you can set the parameters such as ring duration and speaking duration. For details, refer to [\*\*Set Access Control and Video Intercom Parameters\*\*](#) .

### 17.2.1 Call Indoor Station from Client

You can call the added indoor station by the client to perform video intercom.

#### Before You Start

- Be sure to have added a resident to the client. For details, refer to [\*\*Add Single Person\*\*](#) .
- Be sure to have linked the resident with an indoor station and configured the resident information (including floor No. and room No.) in Person module. For details about configuring the linkage and resident information, refer to [\*\*Configure Resident Information\*\*](#) .

## Steps

---

### Note

- A video intercom device can be added to more than one client, but perform video intercom with only one client at a time.
  - You can remotely configure the Max. Ring Duration and the Max. Speaking Duration.
- 

1. Click **Access Control** → **Video Intercom** → **Contacts** .

2. Unfold the organization list on the left panel and select an organization.

The information (including resident name, device name, floor No. and room No.) of all the residents in the selected group will be displayed on the right panel.

3. Select a resident, or enter a keyword in the Filter field to find the desired resident.

4. Click  to start calling the selected resident.

After the call is answered, you will enter the In Call window.

5. **Optional:** After the call is answered, perform the following operation(s).

**Adjust Loudspeaker Volume** Click  to adjust the volume of the loudspeaker.

**End Speaking** Click **Hang Up** to end speaking.

**Adjust Microphone Volume** Click  to adjust the volume of the microphone.

## 17.2.2 Answer Call via Client

You can answer call from the added indoor station, door station, or specific access control device via the client and perform video intercom.

## Steps

---

### Note

A video intercom device can be added to more than one client, but perform video intercom with only one client at a time.

---

1. Call the client by an indoor station, door station, or specific access control device.

An incoming call dialog will pop up.

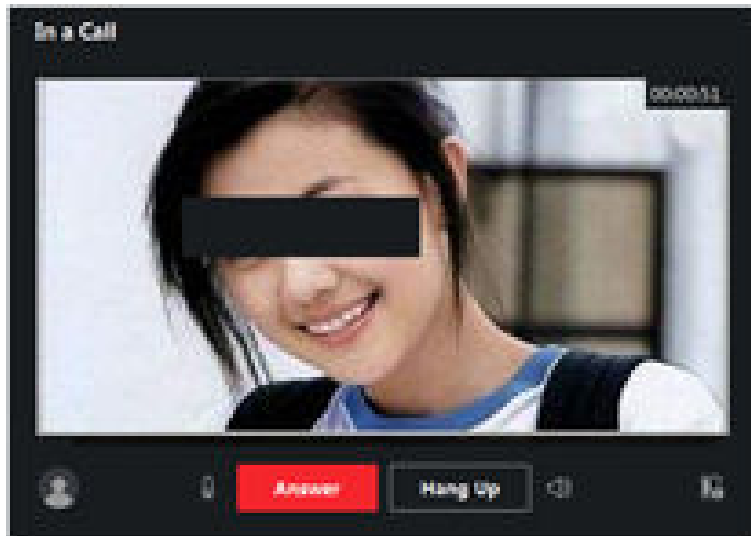

**Figure 17-2 Incoming Call**

2. Click **Answer** to answer the call.

After the call is answered, you will enter the In Call window.

3. **Optional:** In the In Call window, perform the following operation(s).

**Adjust Loudspeaker Volume**

Click  to adjust loudspeaker's volume.

**End Speaking**

Click **Hang Up** to end speaking.

**Adjust Microphone Volume**

Click  to adjust the microphone's volume.

**Open Door**

When an indoor station is linked with a door station, click  to open the door linked with the door station.

## 17.3 View Real-Time Call Logs

You can view details of all the calls, and you can call the residents or export the logs if they are needed.

### Steps

1. Click **Access Control** → **Video Intercom** → **Call Log** .

Details of all the calls will be displayed on the right panel including call status, start time, speaking duration, device type and name, and organization and name of resident.

2. **Optional:** Click  to re-dial the resident.

3. **Optional:** Set search conditions (including call status, device type, and time) on the top of the page to filter call logs.

4. Click **Export** to save the logs (a CSV file) in your PC.

## 17.4 Release a Notice to Resident

You can send a notice to the residents by one-touch. Four notice types are available: advertising, property, alarm, and notice information.

### Steps

1. Click **Access Control** → **Video Intercom** → **Notice** .
2. Click **Add** to open the Create Notice panel.
3. Click  to select the residents you are going to deliver notice to.
4. Enter the required information.

---

### Note

- Up to 63 characters are allowed in the Subject field.
- Up to 1023 characters are allowed in the Content field.
- You can add up to 6 pictures. Each picture should be in JPG format and smaller than 512 KB.

- 
5. Click **Send** to send the notice to the selected resident(s).

Information about the sent notices will be displayed on the left panel. Click a notice to view its details on the right panel.

6. **Optional:** Click **Export** to save all the notices in your PC.

## 17.5 Configure Video Intercom Event

Video intercom events include calling elevator, door bell ring, door locked, etc. You can enable an event for the video intercom device on the client. When the event is triggered on the video intercom device, the client can receive and record event for checking and trigger a series of linkage actions (e.g., sending email) for notification.

### Steps

1. Click **Event Configuration** → **Access Control Event** → **Video Intercom** .
2. Unfold the group and select a video intercom device as event source.

---

### Note

Make sure the resource is online.

All the event types supported by the selected video intercom device will appear.

3. **Optional:** Enter keywords in **Filter** field to locate the desired event quickly.
4. **Optional:** Turn on the switch on the Enable column to enable the event type, or click **Enable All** to enable all the event types of this device.

---

### Note

After enabled, the event can be received by the client and trigger the linkage action(s). You can also disable an event type or disable all event types.

---

**5. Optional:** After selecting the event(s), perform the following operations.

- Edit Priority** Click **Edit Priority** to set the priority of the event(s).  
Priority represents the emergency degree of the event.
- Edit Event Linkage** Click **Edit Linkage** to set the linkage action(s) of the event(s).

### **Audible Warning**

Trigger the client's audible warning when the event is triggered.

You can select the audio file on the drop-down list, or click **Add** to add new audio file (in WAV format).

You can click  to make an audition of the selected audio file.

### **Send Email**

Send an email notification of the alarm information to one or more receivers.

For details about setting email parameters, refer to [\*\*\*Set Email Parameters\*\*\*](#) .

### **Pop-up Window**

Pop-up window to display the event related information (including event details, captured pictures of the linked camera) on the client when the event is triggered. You can also enter remarks about how to handle the event.

### **Display on Map**

When the event source is added as a hot spot on the map, the hot spot will be displayed with  twinkling aside when the event is triggered, which helps security personnel view the location of the event.

You can also click the hot spot to view the event details and the live video of the linked video intercom device.

### **Linked Camera**

Link the selected camera to capture picture or record video when the event is triggered.

- Copy Event Settings** Click **Copy to** to copy the event settings of this video intercom device to other video intercom device(s).

---

### **Note**

You can only copy the event settings to the resource(s) of the same type.

---

### **What to do next**

You need to arm the device which the video intercom device belongs to, otherwise the client cannot receive the configured events. For details, see [\*\*\*Enable Receiving Event from Devices\*\*\*](#) .

## 17.6 Enable Calling between Video Intercom Device and Client

You can enable or disable the calling between the added video intercom devices and the client. If enabled, you can call the intercom device via client, and the client can receive the calling from the device; If disabled, the client and video intercom device cannot call each other.

---

### Note

You needn't enable this function for the door stations added by ISUP for calling.

---

Click  → **Tool** → **Video Intercom Arming Control** to open Video Intercom Arming Control page. The list shows the status of the video intercom devices. You can set the switch to on for the video intercom device to enable calling between the video intercom device and the client. If required, perform the following operations.

- **Filter Device** : If there are too many devices, you can enter the key words in the Filter field to filter the device.
- **Arm All / Disarm All**: Click **Arm All** to arm all devices. Click **Disarm All** to disarm all devices.

## 17.7 Object Missing

This object is not available in the repository.

## Chapter 18 Object Missing

This object is not available in the repository.

### 18.1 Topology Display Overview



The topology display page shows the relationships among different devices obtained by the client, including the devices added to the client, the devices searched via SADP, and the devices connected with the added devices or searched devices. You can check device information, link transmission status, etc.

---

#### Note

- When the devices are searched via SADP, the device names in topology view are consistent with their IP addresses.
- For the unknown device, the topology view will show the device type only.

---

Enter Topology module, click  to get the latest device list and display the topology relationship. If you enter the Topology page for the first time, you can follow the guide and click **Add Topology** to generate the topology view. Then you can click  → **Get Topology Again** to refresh it according to actual requirements.

---

#### Note

You can also click  → **Refresh Status** to get the online or offline status of the devices.

---

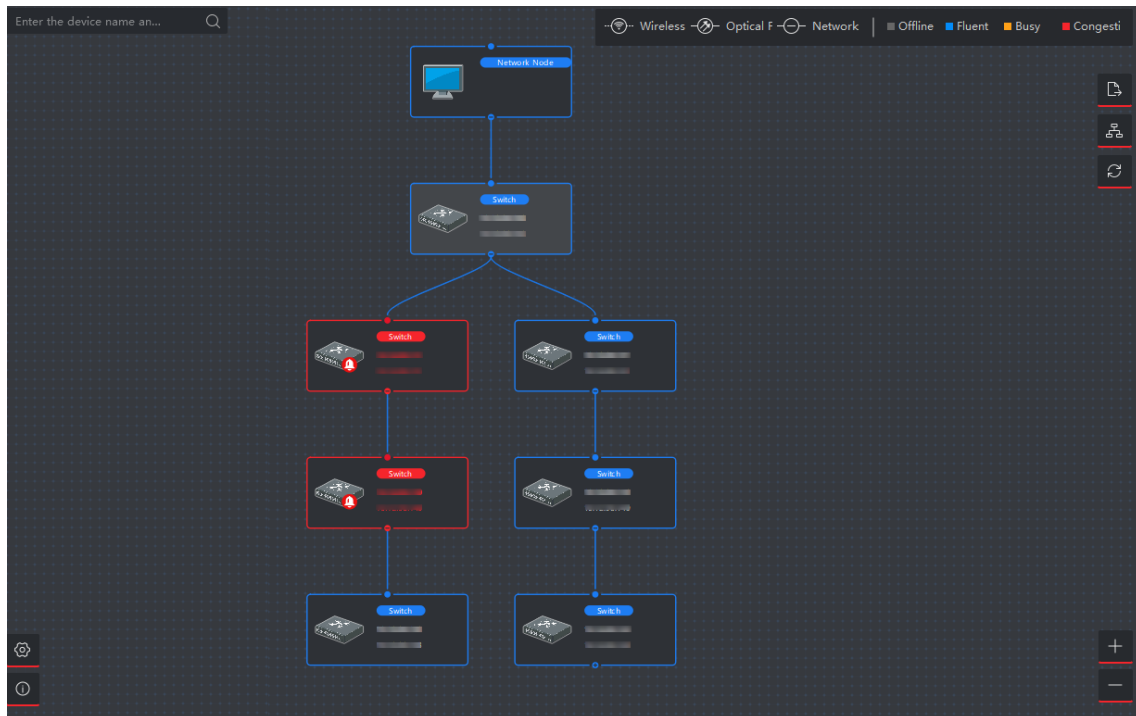



Figure 18-1 Topology Display

## Device Node

- **View Device information:** You can check the device type and IP address.

### Note

If the device name, IP address, online status, or other information of the device is edited, the device information in topology view will change synchronously.

- **Expand/Hide:** You can click  或  to expand or hide the sub node(s) of certain device.
- **Adjust Topology View:** On the lower right corner, you can click the icons or scroll your mouse wheel to enlarge or narrow the typology.
- **Search Topology:** On the top left corner, you can enter another name or IP address of a device to view the corresponding typology.

## Line

On the top right corner, you can view the icon of lines (wireless, optical fiber, and network) and the meaning of different colors.



## 18.2 Set Topology Parameters

You can set the parameters for the topology display, including display level and bandwidth alarm threshold.



Enter Topology module, and click  in lower left corner to set the related parameters as follows.

### Set Display Level

When there are too many devices combined into a complex topology, you can set the display level to show the main structure more clearly. After changing the typology settings, you need to click  to view the latest topology. If the device node is hidden, you can click  to expand the hidden the device node.

### Set Upstream Bandwidth L1/L2 Alarm

You can set upstream bandwidth L1 alarm and L2 alarm. The line will turn to yellow (busy)/red (congestion) when the bandwidth exceeds the threshold of L1/L2 alarm.

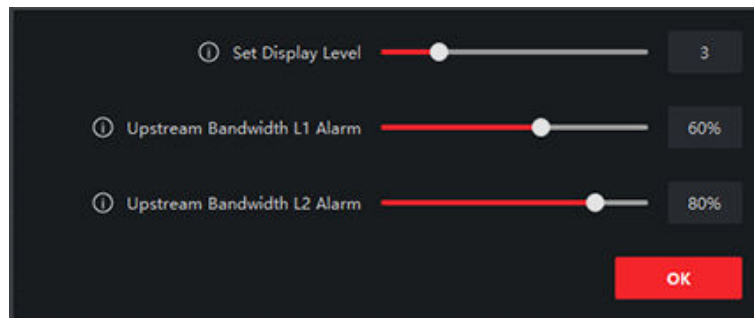

Figure 18-2 Set Topology Parameters

## 18.3 View Device Details

You can view the details of the devices in topology, such as basic information, device usage, device panel status, and port information.

On Topology page, double-click the device node to show the device details as follows.

### Basic Information

The basic information shows the device type, model, and IP address of the device.

### Device Panel Status

The device panel status shows the supported port type, and port usage.

### Port Information

The port information shows the ports of the device, and the peer device information.

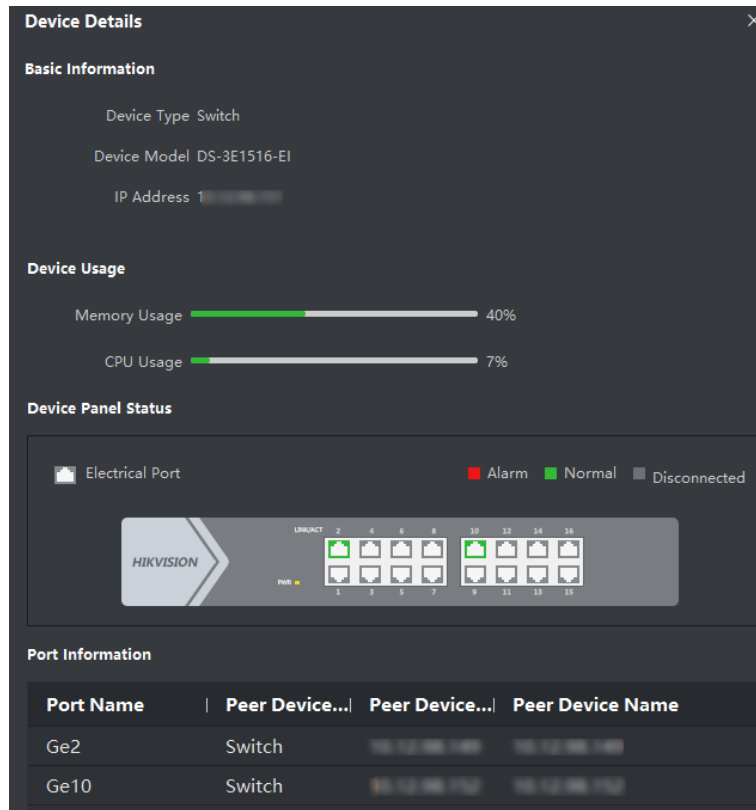

**Figure 18-3 Device Details**

## 18.4 View Link Details

You can view the details of the link between two device nodes, such as transmission rate, device type, port status, IP address, and port name of each device.

On Topology page, double-click the line between two device nodes to show the link details as follows.

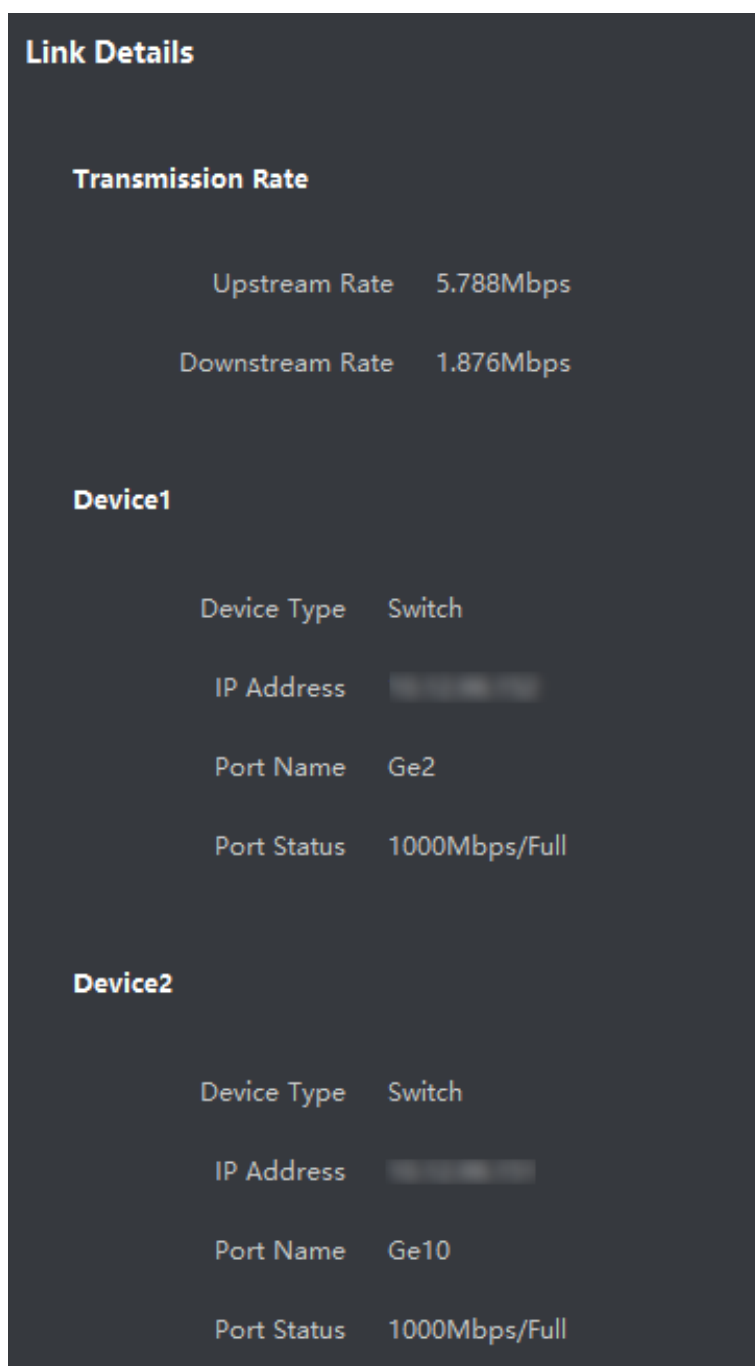



Figure 18-4 Link Details

## 18.5 Object Missing

This object is not available in the repository.

## 18.6 Export Topology

You can export the topology view as PDF file, in order to view the device connection status, level, type, IP address and other information.

On Topology page, click , and select the path to export the topology.

## 18.7 Object Missing

This object is not available in the repository.

## Chapter 19 Log Search

Two log types are provided: operation log and system log. The operation logs refer to the normal operations that the user did on the client, such as adding device, resetting password, starting live view, etc.; and the system logs record the system information, such as login, logout, locking and unlocking, etc. You can search the log files and view the log details, including time, user, etc.

### Steps

1. Enter the Log Search module.
2. Click  to specify the start time and end time.



### Note

You can search the logs within one month.

3. Select a user to search the log files which are generated when this user operate on the client.
4. Select **Operation Log** or **System Log** as log type.
5. Click **Search**.

The log files between the start time and end time will be displayed on the list. You can check the operation time, type and other information of the logs.

6. **Optional:** Perform the following operations if there are too many log files.

**Filter** Click  on each table header and select to filter the logs.

**Sort** Click the table header to sort the logs by the time or letter sequence.

## Chapter 20 User Management

To improve the system security, the administrator should create different account for different user, and assign different permissions to the user. To avoid different people sharing the same user account, we recommend you manage the user accounts periodically.

### 20.1 Add User

The super user and administrator can add new users, and assign different permissions for different users if needed.

Perform this task to add an user account.

#### Steps

---



The user account you registered to log in the software is set as the super user.

---

1. Enter the User Management module.
2. Click **Add User** to show user information area.
3. Select the user type from the drop-down list.

#### **Administrator**

The administrator account has all permissions by default, and can modify the passwords and permissions of all operators and its own.

#### **Operator**

The operator account has no permission by default and you can assign the permissions manually. An operator can only change the passwords of its own account and the accounts which are added by it.

4. Enter the user name, password, and confirm password as desired.
- 



The password strength of the device can be automatically checked. We highly recommend you change the password of your own choosing (using a minimum of 8 characters, including at least three kinds of following categories: upper case letters, lower case letters, numbers, and special characters) in order to increase the security of your product. And we recommend you change your password regularly, especially in the high security system, changing the password monthly or weekly can better protect your product.

Proper configuration of all passwords and other security settings is the responsibility of the installer and/or end-user.

---

5. Check the checkboxes to assign the permissions to the created user.
  6. **Optional:** Click **Default Value** to restore the default permissions of this user.
-

7. Click **Save**.



Up to 50 user accounts can be added for the client software.

---

After created user account successfully, the user account is added to the user list on the Account Management page.

8. **Optional:** Perform the following operations after the user account is created.

**Edit User** Click a user from the list to edit the user information.

---



Only the password of the super user can be edited.

---

**Delete User** Select the user from the list and click **Delete User**.

---



You cannot delete the super user.

---

## 20.2 Change User's Password

The administrator can change normal user's password without entering the old password, while the administrator should enter the old password when changing the password of itself.

### Before You Start

Add user to the software client.

### Steps

1. Enter the User Management module.
  2. Select the user need to be change password, click **Change**.
  3. **Optional:** Enter the old password.
- 



When changing the administrator's password, you need to enter the old password first.

---

4. Enter the new password and confirm the password.
5. Click **OK**.

## Chapter 21 System Configuration

### 21.1 Set General Parameters

You can configure the frequently-used parameters, including log expired time, network performance, etc.

#### Steps

1. Enter the System Configuration module.
2. Click **General** tab to enter the General Settings page.
3. Configure the general parameters.

#### Date Format / Time Format

The display style of date and time on related pages.

#### Log Retention Period

The time for keeping the log files. Once exceeded, the files will be deleted.

#### Maximum Mode

Select **Maximize** or **Full Screen** as the maximum mode. **Maximize** mode can maximize the display and show the taskbar. **Full Screen** mode can display the client in full-screen mode.

#### Network Performance

Set the network conditions to **Normal**, **Better** or **Best**.

#### Save Pictures in Structure Data Format

- After **Save Pictures in Structure Data Format** is enabled, the **Delete Registered Picture in Person** module will be available. If a person's information is applied to the device(s) successfully, the person's picture will be automatically deleted and no picture will be displayed in Basic Information. The **Face** column in **Person** module will display the number of the added face picture(s).
- When **Save Pictures in Structure Data Format** is enabled, no pictures will be displayed in Event Details field in Event Center.

#### Enable Keyboard and Joystick

Enable the keyboard or joystick. After enabled, you can set the shortcuts for the keyboard and joystick.



#### Note

For details, refer to [\*Set Keyboard and Joystick Shortcuts\*](#) .

---

#### Export Person Information

If you enable this, the **Export** button for exporting person information will be displayed on the Person Management page. Please pay attention to person information security.

#### Event Retention Period



The time period for keeping the event information. When the retention period expires, the event record will be deleted automatically.

### **Automatic Time Synchronization**

Automatically synchronize the time of the added devices with the time of the PC running the client at a specified time point.

### **Auto-Upgrade Device**

Set the upgrading mode after the new version of device are detected.

#### **Disable**

After enabled, the client will not download the firmware package and upgrade even if the client detects a new version of the client.

#### **Prompt Me If Download and Upgrade**

After the client detects a new version of the device, it will prompt the user whether to download the firmware package and upgrade.

#### **Download and Prompt Me If Upgrade**

After the client detects the new version of the device, it will download the firmware package automatically, and prompt the user whether to upgrade.

#### **Download and Prompt Automatically**

After the client detects the new version of the devices, it will download the firmware package and upgrade the new version automatically.

You need to set a schedule in the **Upgrade Time** field, during which the client upgrades the new version automatically.

### **Country/Region**

Select the server's region for Hik-Connect, you can select the region you belong to or the nearest region around.

4. Click **Save**.

## **21.2 Set Live View and Playback Parameters**

You can set the parameters for live view and playback, including picture format, pre-play duration, etc.

### **Steps**

1. Enter the System Configuration module.
2. Click **Live View and Playback** tab.
3. Configure the live view and playback parameters.

#### **Picture Format**

Select **JPEG** or **BMP** as the image format for storing pictures.



If **Display Temperature on Captured Pictures** switch is set to ON, JPEG is selected as the image format by default and cannot be changed.

---

## **Video Format**

Select **MP4/AVI** as the format of recorded videos.

## **Merge Downloaded Video Files**

Set the maximum size of merged video file for downloading the video file by date.

## **Search Video Files Stored in**

Search the video files stored in the local device, in the storage server, or both in the storage server and local device for playback.

## **Pre-play for**

Set the pre-play time for event playback. By default, it is 30s.

## **Prioritize Playback of Video Files on Storage Server**

Play back the video files recorded on the storage server preferentially. Otherwise, play back the video files recorded on the local device.

## **Resume Latest Live View Status After Restart**

Resume the latest live view status after you log into the client again.

## **Disconnect Background Videos in Single Live View**

In multiple-window division mode, double-click a live video to display it in 1-window division mode, and the other live videos will be stopped for saving the resource.

## **Enable Wheel for Zoom**

Use the mouse wheel for zoom in or out of the video in PTZ mode, or for zoom in or restoring of the video in digital zoom mode. In this way, you can directly zoom in or out (or restore) the live video by scrolling the mouse.

## **Skip Unconcerned Video during VCA Playback**

Skip the unconcerned video during VCA playback and the unconcerned video will not be played during VCA playback.

4. Click **Save**.

## **21.3 Set Image Parameters**

The image parameters of the client can be configured, such as view scale, play performance, etc.

### **Steps**

1. Open the System Configuration page.
2. Click **Image** tab to enter the Image Settings interface.
3. Configure the image parameters.

## View Scale

The view scale of the video in live view or playback. It can be set as **Full Screen**, **4:3**, **16:9**, or **Original Resolution**.



You can also set the view scale in Live View module. For details, refer to [Live View](#).

---

## Play Performance

The play performance of the live video. It can be set as **Shortest Delay**, **Balanced**, or **Fluency**.

You can also select **Custom** and configure the frame rate according to actual needs.

## Hardware Decoding Preferred

Select **D3D9** or **D3D11** to enable decoding by hardware for live view and playback. Hardware Decoding can provide better decoding performance and lower CPU usage when playing the HD video during live view or playback.

## Enable Highlight

Mark the detected objects with green rectangles in live view and playback.

## Display Transaction Information

Display the transaction information on the live view image.

## VCA Rule

Display the VCA rule in the live view.

## Enable Frame Extracting for High-speed Playback

When playing back the video at high speed (8x speed and above), you can disable this function to make the image of playback more fluent to view the details.

## Display Target's Pattern

After enabled, you can view the target person's motion track on the view window.

## Overlay Rules on Captured Picture

For the thermal device, set to display the temperature information and fire source information on the captured pictures.



After enabled this function, the Picture Format configured in **System Configuration** → **Live View and Playback** will change to JPEG and is not editable.

---

## Noise Reduction

Noise reduction mode, which can be set as **Disable**, **Self-adaptive**, or **Enable**.

4. Click **Save**.

## 21.4 Set Picture Storage

The captured pictures triggered by the events on the devices, can be saved in the PC running the iVMS-4200 Service. You can set the picture storage location here manually.

### Steps

1. Enter the System Configuration module.
2. Click **Event Picture Storage**.
3. Set the **Store Pictures in Server** switch to on.  
All the disks of the PC running the iVMS-4200 service will show.
4. Select the disk to save the pictures.



The default saving path is: Disk/iVMS-4200alarmPicture





---

5. Click **Save**.

## 21.5 Set Alarm Sound

When the event is triggered, the client can give an audible warning to notify the security personnel. You can set the sound of the audible warning in this section.

### Steps

1. Open the System Configuration page.
2. Click **Alarm Sound** tab to enter the Alarm Sound Settings page.
3. **Optional:** Click  and select the audio files from the local path for different events.
4. **Optional:** Add customized alarm sound.
  - 1) Click **Add** to add customized alarm sound.
  - 2) Double click the **Type** field to customize the alarm sound name as desired.
  - 3) Click  and select the audio files from the local path for different alarms.
5. **Optional:** Click  for a testing of the audio file.
6. **Optional:** Click  in the Operation column to delete the custom sound.
7. Click **Save**.



The format of the audio file can only be WAV.

---

## 21.6 Set Access Control and Video Intercom Parameters



You can configure the access control and video intercom parameters according to actual needs.

### Steps

1. Open the System Configuration page.

2. Click the **Access Control & Video Intercom** tab.
3. Input the required information.

### **Ringtone**

Click  and select the audio file from the local path for the ringtone of indoor station. Optionally, you can click  for a testing of the audio file.

### **Max. Ring Duration**

Specify the seconds that the ring will last for at most. The maximum ring duration can be set from 15s to 60s.

### **Max. Speaking Duration with Indoor Station**

Specify the seconds that the call with indoor station will last for at most. The maximum speaking duration between indoor station and the client can be set from 120s to 600s.

### **Max. Speaking Duration with Door Station**

Specify the seconds that the call with door station will last for at most. The maximum speaking duration between door station and the client can be set from 90s to 120s.

### **Max. Speaking Duration with Access Control Device**

Specify the seconds that the call with access control device will last for at most. The maximum speaking duration between access control device and the client can be set from 90s to 120s.

4. Click **Save**.

## **21.7 Set File Saving Path**

The video footage (manually recorded during live view and clipped during playback) and captured pictures are stored on the local PC. The saving path of these files can be set.

### **Steps**

1. Open the System Configuration page.
2. Click **File** tab to enter the File Saving Path Settings page.
3. Click  and select a local path for the files.
4. Click **Save**.

## **21.8 Set Icons Shown on Toolbar**

The icons and the order on the toolbar in the live view and playback window can be customized. You can set to display what icons and set the icon order.









Perform the following task when you need to set icons shown on Toolbar.

### **Steps**







1. Enter the System Configuration module.
2. Click **Toolbar** tab to enter the Toolbar Settings page.

3. Set **Enable Screen Toolbar Display** switch to ON to enable displaying the toolbar on in the live view and playback window.
4. Click the required icon to display on the toolbar.
5. **Optional:** Drag the icon to set the icon order when displaying on the toolbar.

**Table 21-1 Icons on Live View Toolbar**

	<b>Stop Live View</b>	Stop the live view in the display window.
	<b>Capture</b>	Capture the picture in the live view process. The capture picture is stored in the PC.
	<b>Record</b>	Start manual recording. The video file is stored in the PC.
	<b>PTZ Control</b>	Start PTZ mode for speed dome. Click and drag in the view to perform the PTZ control.
	<b>Two-way Audio</b>	Start the two-way audio with the device in live view.
	<b>Digital Zoom</b>	Enable the digital zoom function. Click again to disable the function.
	<b>Instant Playback</b>	Switch to the instant playback mode.
	<b>Remote Configuration</b>	Open the remote configuration page of the camera in live view.

**Table 21-2 Icons on Playback Toolbar**

	<b>Capture</b>	Capture the picture in the live view process. The capture picture is stored in the PC.
	<b>Record</b>	Start manual recording. The video file is stored in the PC.
	<b>Digital Zoom</b>	Enable the digital zoom function. Click again to disable the function.
	<b>Download</b>	Download the video files of the camera and the video files are stored in the PC.
	<b>VCA Playback</b>	Set the VCA rules. For more details, refer to <b><u>VCA Playback</u></b> .
	<b>Tag Control</b>	Add default or custom tag for the video files to mark the important video point. You can also edit the tag.

6. Click **Save**.

## 21.9 Set Keyboard and Joystick Shortcuts

The keyboard can be connected to the client and be used to control the PTZ cameras. You can set the shortcuts for keyboard and joystick to get quick and convenient access to the commonly used actions.

Perform this task when you need to set keyboard and joystick shortcuts.

### Steps

---



#### Note

This configuration page will display after enabling keyboard and joystick in General Settings. For details, refer to [Set General Parameters](#).

---

1. Enter the System Configuration module.
2. Click **Keyboard and Joystick** to show the Keyboard and Joystick Shortcut Settings area.
3. Select the COM port from the drop-down list for keyboard if the keyboard is connected to the PC installed with the client.



#### Note

You can enter the Device Manger of the PC to check the COM port, which the keyboard is connected to.

---

4. Set shortcuts for keyboard and joystick.
  - 1) Select a certain function name on Function column.
  - 2) Double-click the item field under the PC Keyboard, USB Joystick or USB Keyboard column.
  - 3) Select the compound keys operation or number from the drop-down list to set it as the shortcuts for the function of the keyboard or USB joystick.
5. Click **Save**.

### Example

For the **Focus (+)** function, if you set **Home**, **1**, and **F1** as the shortcuts of the PC Keyboard, USB Joystick and USB Keyboard, you can press the Home key on PC keyboard, control the joystick to the 1 direction, or press F1 key on USB keyboard to zoom in.

## 21.10 Set Email Parameters

When an event is triggered, if you can set **Send Email** as linkage action for this event, the client will an email to the recipients for notification. You need to set the email settings and specify target recipients in this section.

### Steps

1. Enter the System Configuration module.
2. Click **Email** tab to enter the Email Settings interface.
3. Enter the required information.

### SMTP Server

The SMTP server IP address of host name (e.g., smtp.263xmail.com)

### Encryption Type

You can check the radio to select **Non-Encrypted**, **SSL**, or **STARTTLS**.

### Port

Enter the communication port used for SMTP. The port is 25 by default.

### Sender Address

The email address of the sender.

### Security Certificate (Optional)

If your email server requires authentication, check this checkbox to use authentication to log into the server and enter the login user name and password of your email account.

#### User Name

Enter the user name of the sender email address if **Server Authentication** is checked.

#### Password

Enter the password of the sender Email address if **Server Authentication** is checked.

### Receiver 1 to 3

Enter the email address of the receiver. Up to 3 receivers can be set.

**4. Optional:** Click **Send Test Email** to send an email to the receiver for test.

**5.** Click **Save**.

## 21.11 Manage Security Authentication

For the data security purpose, the security certificate of clients and added servers should be same. You can set the verify certificate is required or not when enabling transmission encryption using TLS (Transport Layer Security) protocol.

Before adding a server to the client, you should export the service certificate from the client service, and import it to the server. If multiple clients use the same server, you should make the security certificates of the clients and the server same with each other.

### 21.11.1 Export Certificate from Service Management

You can export the security certificate from the current client service and import the exported certificate file to other clients.

#### Steps

1. Enter the Service Management.
2. Click **Export** to save the certificate file in the local PC.



---

 **Note**

The certificate file is in XML format.

---

### What to do next

After exporting the certificate, you can copy the certificate to the PC installed with the client and import it to other clients.

### 21.11.2 Import Certificate to Client

If there are multiple clients accessing the same steam media server, you should import the same certificate to the clients and server.

#### Before You Start

Make sure you have exported the security certificate from one of the client service.

---

 **Note**

For details, refer to *[Export Certificate from Service Management](#)* .

---

#### Steps

1. Copy the certificate file exported from other client to the local PC.
  2. Enter the System Configuration module.
  3. Click **Security Authentication** tab to enter the security authentication setting interface.
  4. Click **Import**.
  5. Select the certificate file from your local PC and click **Open**.
- 

 **Note**

Please restart the client to take effect.

---

### 21.11.3 Certificate Verification for Transmission Encryption

On the Security Authentication page, you can set the device certificate verification is required or not for transmission encryption.

Click **System Configuration** → **Security Authentication** to enter the security authentication interface. Select the Verify Certificate as **Yes** or **No**.

#### Yes

You must put the device certificate to the designed directory if you enable transmission encryption when adding device. And the device will be added with transmission encryption and the certificate will be verified, which improves the security level.

#### No

The device certificate is not required if you enable transmission encryption when adding device. And the device will be added with transmission encryption.

## Chapter 22 Operation and Maintenance

You can perform maintaining operations in the menu to ensure a smooth and convenient usage of the client.

In the upper-right corner of the client, click  → **File** → **System** → **Tool** , and perform the following operations.

### Open Log File

You can open a log file saved in your local PC or log files of the client.

### Import/Export Configuration File

You can import configuration files from local PC to the client if needed, and vice versa.

### Auto Backup

Select day and time to backup configuration files and data in database, or restore the backed up data.

### Skin

Change the skin of the client, including bright-color series and black-color series.

### Broadcast

Check one or more devices to enable the broadcast function of the devices.

### Batch Wiper Control

Batch turn on/off the wiper.

### 1 VS 1 Face Comparison

Select two face pictures from the local PC for comparison. The similarity between the two pictures will be shown.



#### Note

This function can be used for identity verification and should be supported by the DeepinMind device.

---

### Batch Time Sync

Synchronize selected devices' time with your PC time.

### Message Queue

After configuring email linkage, the triggered event(s) will be displayed here. Select an event and cancel sending the an email to the receiver.

## Appendix A. Custom Wiegand Rule Descriptions

Take Wiegand 44 as an example, the setting values in the Custom Wiegand tab are as follows:

Custom Wiegand Name	Wiegand 44				
Total Length	44				
Transformation Rule (Decimal Digit)	byFormatRule[4]=[1][4][0][0]				
Parity Mode	XOR Parity				
Odd Parity Start Bit		Length			
Even Parity Start Bit		Length			
XOR Parity Start Bit	0	Length per Group	4	Total Length	40
Card ID Start Bit	0	Length	32	Decimal Digit	10
Site Code Start Bit		Length		Decimal Digit	
OEM Start Bit		Length		Decimal Digit	
Manufacturer Code Start Bit	32	Length	8	Decimal Digit	3

### Wiegand Data

Wiegand Data = Valid Data + Parity Data

### Total Length

Wiegand data length.

### Transportation Rule

4 bytes. Display the combination types of valid data. The example displays the combination of Card ID and Manufacturer Code. The valid data can be single rule, or combination of multiple rules.

### Parity Mode

Valid parity for Wiegand data. You can select either odd parity or even parity.

### Odd Parity Start Bit, and Length

If you select Odd Parity, these items are available. If the odd parity start bit is 1, and the length is 12, then the system will start odd parity calculation from bit 1. It will calculate 12 bits. The result will be in bit 0. (Bit 0 is the first bit.)

### **Even Parity Start Bit, and Length**

If you select Even Parity, these items are available. If the even parity start bit is 12, and the length is 12, then the system will start even parity calculation from bit 12. It will calculate 12 bits. The result will be in the last bit.

### **XOR Parity Start Bit, Length per Group, and Total Length**

If you select XOR Parity, these items are available. Depending on the table displayed above, the start bit is 0, the length per group is 4, and the total length is 40. It means that the system will calculate from bit 0, calculate every 4 bit, and calculate 40 bits in total (10 groups in total). The result will be in the last 4 bits. (The result length is the same as the length per group.)

### **Card ID Start Bit, Length, and Decimal Digit**

If you use the transformation rule, these items are available. Depending on the table displayed above, the card ID start bit is 0, the length is 32, and the decimal digit is 10. It represents that from bit 0, there are 32 bits represent the card ID. (The length here is calculated by bit.) And the decimal digit length is 10 bits.

### **Site Code Start Bit, Length, and Decimal Digit**

If you use the transformation rule, these items are available. For detailed information, see the explanation of the card ID.

### **OEM Start Bit, Length, and Decimal Digit**

If you use the transformation rule, these items are available. For detailed information, see the explanation of the card ID.

### **Manufacturer Code Start Bit, Length, and Decimal Digit**

If you use the transformation rule, these items are available. Depending on the table displayed above, the manufacturer code start bit is 32, length is 8, and decimal digit is 3. It represents that from bit 32, there are 8 bits are manufacturer code. (The length here is calculated by bit.) And the decimal length is 3.

## Appendix B. Troubleshooting

Here are some common symptoms when operating the client software. We provide the possible causes and corresponding solutions to solve the problems.

### B.1 Failed to get the live view of a certain device.

#### Problem

Failed to get the live view of a certain device.

#### Possible Reasons

- Unstable network or the network performance is not good enough.
- The device is offline.
- Too many accesses to the remote device cause the load of the device too high.
- The current user has no permission for live view.
- The version of the client software is below the needed version.

#### Solutions

- Check network status and disable other not in use process on your PC.
- Check the device network status.
- Restart the device or disable other remote access to the device.
- Log in with the admin user and try again.
- Download the client software of the latest version.

### B.2 Local recording and remote recording are confused.

#### Problem

Local recording and remote recording are confused.

#### Solutions

- The local recording in this manual refers to the recording which stores the video files on the HDDs, SD/SDHC cards of the local device.
- The remote recording refers to the recording action commanded by the client on the remote device side.

### B.3 Failed to download the video files or the downloading speed is too slow.

### **Problem**

Failed to download the video files or the downloading speed is too slow.

### **Possible Reasons**

- Unstable network or the network performance is not good enough.
- The NIC type is not compatible.
- Too many accesses to the remote device.
- The current user has no permission for playback.
- The version of the client software is below the required version.

### **Solutions**

- Check network status and disable other not in use process on your PC.
- Directly connect the PC running the client to device to check the compatibility of the NIC card.
- Restart the device or disable other remote access to the device.
- Log in with the admin user and try again.
- Download the client software of the latest version.

## Appendix C. FAQ (Frequently Asked Questions)

Here are some frequently asked questions when operating the client software. We provide the corresponding answers to help the users to solve the problems.

### C.1 During live view, why an error message with error code 91 prompts ?

#### Question

During live view, why an error message with error code 91 prompts ?

#### Answer

For live view of multiple windows, the channel may not support sub stream. You should disable the function of **Auto-change Stream Type** in **System Configuration** → **Image** , and select the appropriate steam type for live view.

### C.2 During live view, why the image is blurred or not fluent?

#### Question

During live view, why the image is blurred or not fluent?

#### Answer

Check the driver of video card. We highly recommend you update the driver of video card to the latest version.

### C.3 Why the memory leaked and the client crashed after running for a while?

#### Question

Why the memory leak and the client crashed after running for a while?

#### Answer

In the installation directory of the client software, open the **Setup.xml** file with Notepad and modify the value of **EnableNetandJoystickCheck** to **false**. Restart the client, and if the problem is still not solved, contact our technique support.

## C.4 How to get better performance of live view and playback when network bandwidth is low?

### Question

If the network bandwidth is low, how to get better performance of live view and playback?

### Answer

This function should be supported by the device. You can perform the following operations to realize live view in low bandwidth:



You should disable **Auto-Change Stream Type** beforehand.

---

- Firstly, after adding the encoding devices to the client, you need to set the camera's streaming protocol.
  1. Enter **Device Management** → **Group** .
  2. Select the camera in the Encoding Channel list and click  .
  3. In the Edit Camera window, set the **Protocol Type** (for live view) and **Playback Protocol Type** (for playback) as **Adaptive UDP**.



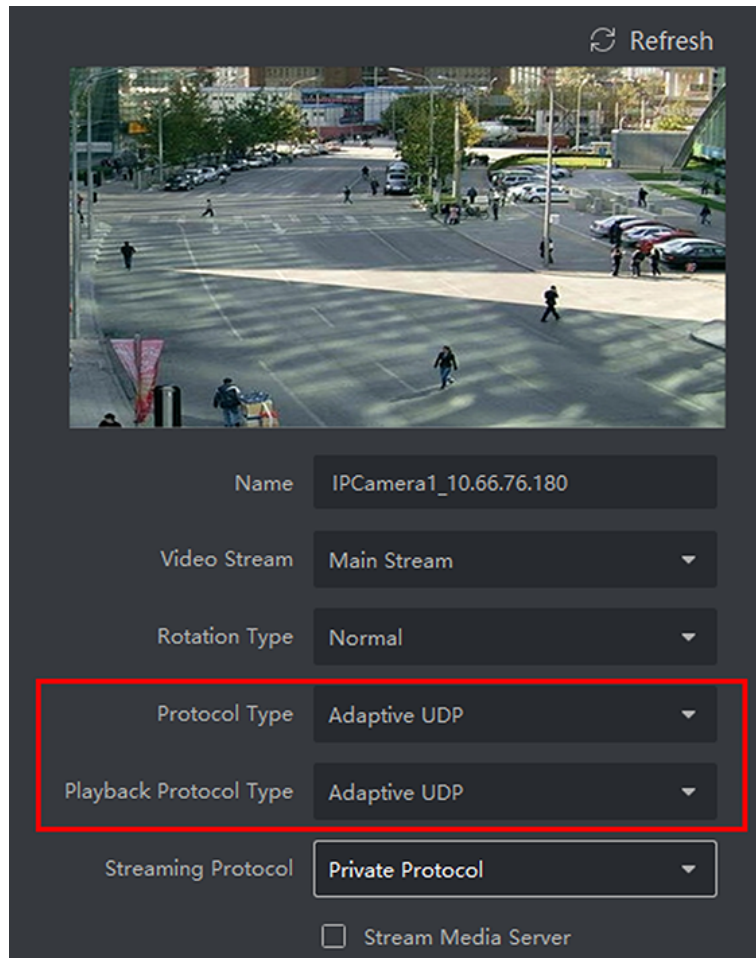

**Figure C-1 Set Protocol Type**

4. Click **OK** to save the settings.
- Select stream type for live view.
  1. Enter Main View module.
  2. In the device list on the left, move the cursor to the camera name and click **...** → **Stream** .



**Figure C-2 Select Stream Type**

3. For network camera, set the stream type as **Third Stream**.  
For DVRs or NVRs, set the stream type as **Virtual Stream**.
4. Start live view.

## Appendix D. Error Code

Code	Error Name	Description
<b>iVMS-4200</b>		
317	No videos.	It will be prompted when the user has no permission to play back.
<b>HCNetSDK.dll</b>		
1	Invalid user name or password.	
2	No permission.	The user in the device has no enough permission.
4	Invalid channel number.	It will be prompted in the live view of remote screen control.
5	No more devices can be connected.	
7	Failed to connect the device.	
23	Not supported.	
29	Operation failed.	
43	No buffer.	It will be prompted when adding a device and the device port is occupied by a web server.
55	Invalid IP address.	
56	Invalid MAC address.	
91	The channel does not support the operation.	It will be prompted when failed to get the sub stream.
96	The device is not registered on the DDNS.	
153	The user is locked.	
250	The device is not activated.	
404	Channel No. error or the device does not support the sub stream.	It will be prompted when failed to get the sub stream or the sub stream does not exist.
424	Failed to receive the data for RTSP SETUP.	It will be prompted when adding the live view for the software DVS via external network.
800	No more bandwidth can be used.	
<b>Playctrl.dll</b>		

<b>Code</b>	<b>Error Name</b>	<b>Description</b>
2		The stream is not a Video & Audio stream.
6		The playback window turns black when adopting H.265 in the 64-bit operating system.

