

24 Series Ethernet Switch

User Manual

UD03706B

User Manual

COPYRIGHT ©2016 Hangzhou Hikvision Digital Technology Co., Ltd.

ALL RIGHTS RESERVED.

Any and all information, including, among others, wordings, pictures, graphs are the properties of Hangzhou Hikvision Digital Technology Co., Ltd. or its subsidiaries (hereinafter referred to be “Hikvision”). This user manual (hereinafter referred to be “the Manual”) cannot be reproduced, changed, translated, or distributed, partially or wholly, by any means, without the prior written permission of Hikvision. Unless otherwise stipulated, Hikvision does not make any warranties, guarantees or representations, express or implied, regarding to the Manual.

About this Manual

This Manual is applicable to DS-C10S-SXXT Series Video Wall Controller.

The Manual includes instructions for using and managing the product. Pictures, charts, images and all other information hereinafter are for description and explanation only. The information contained in the Manual is subject to change, without notice, due to firmware updates or other reasons. Please find the latest version in the company website (<http://overseas.hikvision.com/en/>).

Please use this user manual under the guidance of professionals.

Trademarks Acknowledgement

HIKVISION and other Hikvision’s trademarks and logos are the properties of Hikvision in various jurisdictions. Other trademarks and logos mentioned below are the properties of their respective owners.

Legal Disclaimer

TO THE MAXIMUM EXTENT PERMITTED BY APPLICABLE LAW, THE PRODUCT DESCRIBED, WITH ITS HARDWARE, SOFTWARE AND FIRMWARE, IS PROVIDED “AS IS”, WITH ALL FAULTS AND ERRORS, AND HIKVISION MAKES NO WARRANTIES, EXPRESS OR IMPLIED, INCLUDING WITHOUT LIMITATION, MERCHANTABILITY, SATISFACTORY QUALITY, FITNESS FOR A PARTICULAR PURPOSE, AND NON-INFRINGEMENT OF THIRD PARTY. IN NO EVENT WILL HIKVISION, ITS DIRECTORS, OFFICERS, EMPLOYEES, OR AGENTS BE LIABLE TO YOU FOR ANY SPECIAL, CONSEQUENTIAL, INCIDENTAL, OR INDIRECT DAMAGES, INCLUDING, AMONG OTHERS, DAMAGES FOR LOSS OF BUSINESS PROFITS, BUSINESS INTERRUPTION, OR LOSS OF DATA OR DOCUMENTATION, IN CONNECTION WITH THE USE OF THIS PRODUCT, EVEN IF HIKVISION HAS BEEN ADVISED OF THE POSSIBILITY OF SUCH DAMAGES.

REGARDING TO THE PRODUCT WITH INTERNET ACCESS, THE USE OF PRODUCT SHALL BE WHOLLY AT YOUR OWN RISKS. HIKVISION SHALL NOT TAKE ANY RESPONSIBILITIES FOR ABNORMAL OPERATION, PRIVACY LEAKAGE OR OTHER DAMAGES RESULTING FROM CYBER ATTACK, HACKER ATTACK, VIRUS INSPECTION, OR OTHER INTERNET SECURITY RISKS; HOWEVER, HIKVISION WILL PROVIDE TIMELY TECHNICAL SUPPORT IF REQUIRED.

SURVEILLANCE LAWS VARY BY JURISDICTION. PLEASE CHECK ALL RELEVANT LAWS IN YOUR JURISDICTION BEFORE USING THIS PRODUCT IN ORDER TO ENSURE THAT YOUR USE CONFORMS THE APPLICABLE LAW. HIKVISION SHALL NOT BE LIABLE IN THE EVENT THAT THIS PRODUCT IS USED WITH ILLEGITIMATE PURPOSES.

IN THE EVENT OF ANY CONFLICTS BETWEEN THIS MANUAL AND THE APPLICABLE LAW, THE LATER PREVAILS.

Regulatory Information

FCC Information

Please take attention that changes or modification not expressly approved by the party responsible for compliance could void the user's authority to operate the equipment.

FCC compliance: This equipment has been tested and found to comply with the limits for a Class A digital device, pursuant to part 15 of the FCC Rules. These limits are designed to provide reasonable protection against harmful interference when the equipment is operated in a commercial environment. This equipment generates, uses, and can radiate radio frequency energy and, if not installed and used in accordance with the instruction manual, may cause harmful interference to radio communications. Operation of this equipment in a residential area is likely to cause harmful interference in which case the user will be required to correct the interference at his own expense.

FCC Conditions

This device complies with part 15 of the FCC Rules. Operation is subject to the following two conditions:

1. This device may not cause harmful interference.
2. This device must accept any interference received, including interference that may cause undesired operation.

EU Conformity Statement



This product and - if applicable - the supplied accessories too are marked with "CE" and comply therefore with the applicable harmonized European standards listed under the EMC Directive 2014/30/EU, the LVD Directive 2014/35/EU, the RoHS Directive 2011/65/EU.



2012/19/EU (WEEE directive): Products marked with this symbol cannot be disposed of as unsorted municipal waste in the European Union. For proper recycling, return this product to your local supplier upon the purchase of equivalent new equipment, or dispose of it at designated collection points. For more information see: www.recyclethis.info



2006/66/EC (battery directive): This product contains a battery that cannot be disposed of as unsorted municipal waste in the European Union. See the product documentation for specific battery information. The battery is marked with this symbol, which may

include lettering to indicate cadmium (Cd), lead (Pb), or mercury (Hg). For proper recycling, return the battery to your supplier or to a designated collection point. For more information see: www.recyclethis.info

Industry Canada ICES-003 Compliance

This device meets the CAN ICES-3 (A)/NMB-3(A) standards requirements.

Preparing for installation

The HIKVISION 24 Series Ethernet Switch includes the following models:

Model	Name
24	Ethernet Switch

Symbol Conventions

The symbols that may be found in this document are defined as follows.



Symbol	Description
 NOTE	Provides additional information to emphasize or supplement important points of the main text.
 WARNING	Indicates a potentially hazardous situation, which if not avoided, could result in equipment damage, data loss, performance degradation, or unexpected results.
 DANGER	Indicates a hazard with a high level of risk, which if not avoided, will result in death or serious injury.

Table of Contents

Chapter 1 24 SWITCH Introduction.....	1
1.1 Appearance Description for Standard Configuration	1
1.2 24 SWITCH Systematic Characteristic Parameters	2
Chapter 2 Installation Preparation	4
2.1 Caution of Usage.....	4
2.2 Safety Advice.....	4
2.2.1 Safety Principles.....	4
2.2.2 Safety Notices	4
2.2.3 Safety Principles for Live Working.....	5
2.2.4 Electrostatic Discharge Damage Prevention	6
2.3 Requirements for Common Locations	6
2.3.1 Environment	6
2.3.2 Location Configuration Prevention	6
2.3.3 Cabinet Configuration.....	6
2.3.4 Power Requirements	7
2.4 Installation Tools and Device	7
Chapter 3 Installing the 24 SWITCH	8
3.1 Installation Flow of 24 SWITCH.....	8
3.2 Installing the Machine Box of the Switch	8
3.2.1 Installing the Machine Box on the Desk	8
3.2.2 Installing the Machine Box on the Cabinet	9
3.3 Connecting the Port.....	9
3.3.1 Connecting the Console Port	9
3.3.2 Connecting Gigabit Ethernet SFP Ports	11
3.3.3 Connecting 1000M Ethernet Base-T ports	11
3.4 Checking After Installation	12
Chapter 4 Maintaining Switch.....	14
4.1 Opening the Machine Box	14
4.2 Closing the Machine Box.....	15
Chapter 5 Hardware Fault Analysis	17
5.1 Fault Separation	17
5.1.1 Faults Relative with Power and Cooling System	17
5.1.2 Faults Relative with Port, Cable and Connection	17
5.2 Indicator Description.....	17
Chapter 6 Specifications	19

Chapter 1 24 SWITCH Introduction

The section describes the characteristics and parameters of 24 SWITCH and gives an overview of 24 SWITCH.

1.1 Appearance Description for Standard Configuration

The built-in ports of 24 SWITCH are: 24 gigabit Ethernet Base-T ports, 4 gigabit Ethernet SFP ports and 1 Console port. See table 1-1.

Port	Attribute
Gigabit Ethernet port	Base-T port: 10/100/1000M auto-adaptation, MDI/MDIX auto-identification, UTP (RJ45) port
Gigabit Ethernet optical port	Optical port: 100/1000M SFP port, Link/Act indicators
Console port	A rate of 9600bps, RJ45 interface

Table 1-1 Attributes of the built-in port

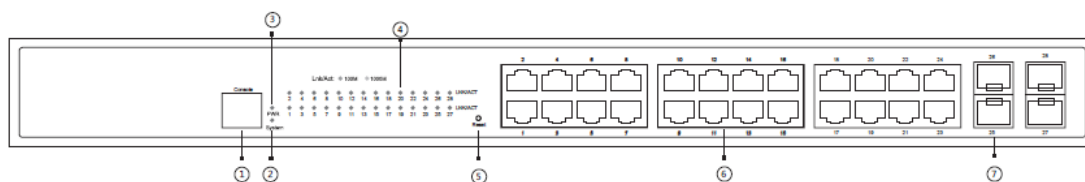

Figure 1-1 Front template of the 24 SWITCH

No.	Abbrev.	Name	Description
1	CONSOLE	Console port	Manages the switch locally.
2	SYS	System indicator	If the indicator is always on, the system is being started. If the indicator flickers, the system works normally.
3	PWR	Power indicator	If the switch is powered on, the indicator is on.
4	Link/ACT	LINK/ACT indicator of each port	If the indicator is on in orange: 10/100M, If the indicator is on in green: 1000M If the indicator is not on: no signal is transmitted.
5	Reset	Reset switch	Return to the factory setting.

6	/	24 gigabit RJ45 ports	Forwards the 10/100M/1000M Ethernet electric signals
7	/	4 SFP ports	Forwards 1000M Ethernet optical signals.

Table 1-2 Parts at the front template of the 24 SWITCH

Besides, 24 SWITCH has a grounding column and a power socket at its back.

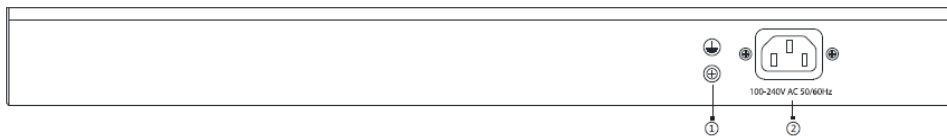

Figure 1-1 Back template of the 24 SWITCH

No.	Abbrev.	Name	Description
1	/	Grounding column	The grounding must be fine.
2	/	AC power socket	100~240V AC

Table 1-3 Parts at the back template of the 24 SWITCH

1.2 24 SWITCH Systematic Characteristic Parameters

Protocol standard	Supported standard	IEEE 802.1d Spanning Tree Protocol IEEE 802.1p Class of Service IEEE 802.1q tagged VLAN IEEE 802.3x Flow control IEEE 802.3ad Link aggregation
	IP routing protocol standard	RFC 1058 RIP RFC 1723 RIP v2
	Network management standard	RFC 1157 SNMP v1/v2 RFC 1213 MIB II RFC 1757 RMON 1,2,3,9
	Standard configuration	4 gigabit SFP ports 1 Console port 24 gigabit Base-T ports

	Dimensions (WxDxH) mm	440×230×45
	Operating temperature/humidity	0°C~45°C; 5%~95% non-condensing
	Storage temperature/humidity	-20°C~70°C; 5%~95% non-condensing
	Power characteristics	Input voltage: AC100~240V; Input frequency: 47~63Hz;

Chapter 2 Installation Preparation

2.1 Caution of Usage

Similar to other electronic products, the semiconductor chip easily gets damaged if you power on or off abruptly and frequently. To restart up the switch of 24 SWITCH, you have to open the power on-off after the power is cut down for three to five seconds.

Avoid severe collision or falling down from the height to protect the parts in the switch.

Do not insert the Ethernet plug into the console port (RJ45 8-line socket). Similarly, do not insert the console cable into the console port (RJ45 8-line socket).

Note:

1) When you plug or dial the power line, keep the power line horizontal with the power socket.

2) When the lifetime of our products ends, handle them according to national laws and regulations, or send these products to our company for collective processing.

2.2 Safety Advice

2.2.1 Safety Principles

- Keep dustless and clean during or after the installation.
- Put the cover at the safe place.
- Put tools at the right place where they are not easily falling down.
- Put on relatively tight clothes fasten the tie or scarf well and roll up the sleeve, avoiding stumbling the machine box.
- Put on the protective glasses if the environment may cause damage to your eyes.
- Avoid incorrect operations that may cause damage to human or devices.

2.2.2 Safety Notices

The safety notices mentioned here means that improper operation may lead to body damage.

-
- Read the installation guide carefully before you operate the system.
 - Only professionals are allowed to install or replace the switch.
 - Pull out the AC power socket and close the direct-current power before operating on the machine box or working beside the power source.
 - The final configuration of products must comply with relative national laws and regulations.

2.2.3 Safety Principles for Live Working

When you work under electricity, following the following principles:

- Put off ornaments, such as ring, necklace, watch and bracelet, before you operate under live working. When metal articles connect the power to the ground, short circuit happens and components may be damaged.
- Pull out the AC power socket and close the direct-current power before operating on the machine box or working beside the power source.
- When the power is on, do not touch the power.
- Correctly connect the device and the power socket.
- Only professionals are allowed to operate and maintain the device.
- Read the installation guide carefully before the system is powered on.

Note:

1) Check potential dangers, such as the humid floor, ungrounded extensible power line and tatty power line.

2) Install the emergent on-off at the working room for turning off the power when trouble happens.

3) Turn off the power on-off of the switch and plug off the power line before installing or uninstalling the machine box or working beside the power.

4) Do not work alone if potential dangers exist.

5) Cut off the power before checkout.

6) If trouble happens, take the following measures:

A. Cut off the system's power.

B. Alarm.

C. Take proper measures to help persons who are hit by the disaster. Artificial respiration is needed if necessary.

D. Seek for medical help, or judge the loss and seek for available help.

2.2.4 Electrostatic Discharge Damage Prevention

Electrostatic discharge may damage devices and circuits. Improper treatment may cause the switch to malfunction completely or discontinuously.

Move or locate the devices according to the measures of electrostatic discharge prevention, ensuring the machine box connects the ground. Another measure is to wear the static-proof hand ring. If there is no hand ring, use the metal clip with the metal cable to clip the unpainted metal part of the machine box. In this case, the static is discharged to the ground through the metal cable of the clip. You can also discharge the static to the ground through your body.

2.3 Requirements for Common Locations

This part describes the requirements for the installation locations.

2.3.1 Environment

The switch can be installed on the desk or the cabinet. The location of the machine box, cabinet planning and indoor cabling are very important for normal system's function. Short distance between devices, bad ventilation and untouchable control plate will cause maintenance problems, systematic faulty and breakdown.

For location planning and device locating, refer to section 2.3.2 "Location Configuration Prevention".

2.3.2 Location Configuration Prevention

The following preventive measures assist you to design the proper environment for the switch.

- Make sure that the workshop is well-ventilated, the heat of electrical devices is well-discharged and sufficient air circulation is provided for device cooling.
- Avoid to damage devices by following the electrostatic discharge prevention procedure.
- Put the machine box at the place where cool air can blow off the heat inside the machine box. Make sure the machine box is sealed because the opened machine box will reverse the cool air flow.

2.3.3 Cabinet Configuration

The following content assists you to make a proper cabinet configuration:

- Each device on the cabinet gives off heat when it runs. Therefore, the sealed cabinet must have the heat-discharge outlet and the cooling fan. Do not put the devices too close, avoiding bad ventilation.

-
- When you install the machine box at the open cabinet, prevent the frame of the cabinet from blocking the airway of the machine box.
 - Ensure that nice ventilation is provided for the devices installed at the bottom of the cabinet.
 - The clapboard separates exhaust gas and inflow air, and boost cool air to flow in the machine box. The best location of the clapboard is decided by the air flow mode in the machine box, which can be obtained through different location tests.

2.3.4 Power Requirements

Make sure that the power supply has nice grounding and the power at the input side of the switch is reliable. The voltage control can be installed if necessary. At least a 240 V, 10A fuse or a breaker is provided in the phase line if you prepare the short-circuit prevention measures for a building.

Caution:

If the power supply system does not have good grounding, or the input power disturbs too much and excessive pulses exist, the error code rate of communication devices increases and even the hardware system will be damaged.

2.4 Installation Tools and Device

The tools and devices to install the 24 SWITCH are not provided by the 24 SWITCH switch. You yourself need to prepare them. The following are the tools and devices needed for the typical installation of the 24 SWITCH switch:

- Screwdriver
- Static armguard
- Bolt
- Ethernet cable
- Other Ethernet terminal devices
- Control terminal

Chapter 3 Installing the 24 SWITCH

Caution:

Only professionals are allowed to install or replace the devices.

3.1 Installation Flow of 24 SWITCH

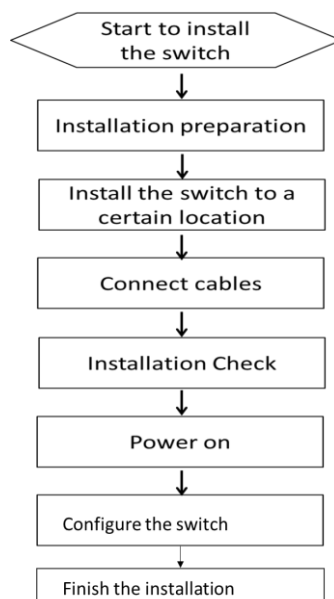

3.2 Installing the Machine Box of the Switch

The installation of the machine box has two modes:

- Installing the machine box on the desk
- Installing the machine box on the cabinet

3.2.1 Installing the Machine Box on the Desk

The 24 SWITCH can be directly put on the smooth and safe desk.

Note:

Do not put things weighing 4.5 kg or over 4.5 kg on the top of the switch.

3.2.2 Installing the Machine Box on the Cabinet

The machine box of the switch is fixed on the cabinet through the brackets. When you fix the brackets, the front template of the switch faces forward. The detailed operations are shown in Figure 3-1.

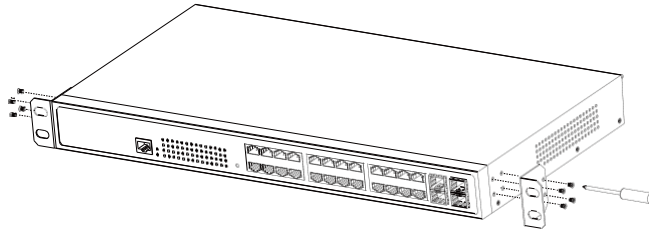

Figure 3-1 Fixing the machine box of the switch

After the brackets are installed, install the switch on the cabinet. See Figure 3-2.

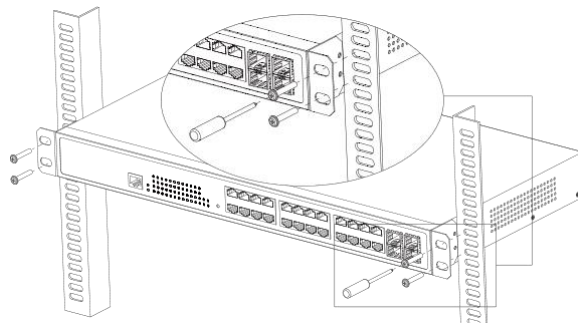

Figure 3-2: Installing the switch on the cabinet

3.3 Connecting the Port

3.3.1 Connecting the Console Port

The switch of 24 SWITCH has a console port.

The rate of the console port is a value ranging from 1200bps to 115200bps. It has a standard RJ45 plug. After you connect the console port to the serial port of PC through a console cable, you can configure and monitor the switch of 24 SWITCH by running the terminal emulation software, such as super Windows terminal. The cable is provided according to the host. The communication parameters of the terminal serial port can be set to a rate of 9600bps, eight data bits, one stop bit, no sum check bit and traffic control.

The RJ45 connector of the console port is shown in Figure 3-3. The RJ45 plug corresponds to the RJ45 socket, whose pins can be aligned from left to right with the value from 1 to 8.

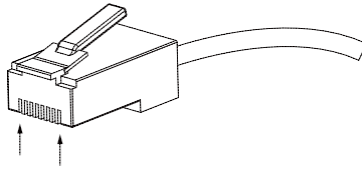

Figure 3-3 RJ-45 connector of the console port

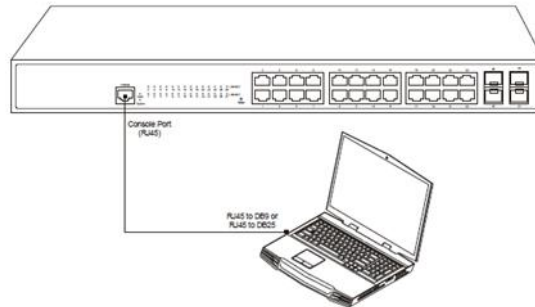

Figure 3-4: Connecting the console port of 24 SWITCH with the computer

No.	Name	Remarks
1	CD	No connect
2	RXD	Input
3	DSR	No connect
4	TXD	Output
5	RTS	No connect
6	CTS	No connect
7	DTR	No connect
8	SG	GND

Table 3-1 Definition of the pins of the Console port

Note: The console port of the 24 SWITCH does not support traffic control. Therefore, you must set the option data traffic control to none when you configure the switch with the super terminal. Otherwise, the single-pass problem will arise on the super terminal.

The cable is used to connect the console port of the 24 SWITCH and the outside console terminal device. One end of the console port is RJ45 8-core plug and the other end of the console port is a 25-hole plug and a 9-hole plug. The RJ45 plug is put into the socket of the console port on the 24 SWITCH switch. DB25 and DB9 is alternative. RJ45 connects to DB9 in the console port shown as below.

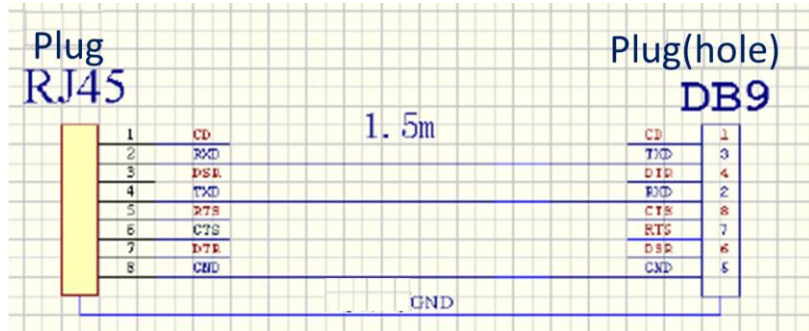

Figure 3-5 Cable connection at the console port

3.3.2 Connecting Gigabit Ethernet SFP Ports

The 24 SWITCH has 4 gigabit SFP ports. Each port has a corresponding indicator for showing their LINK/ACT state. If the indicator is always on, the port is normally linked; if the indicator flickers, the data is forwarded through the port. In use the SFP optical module can be connected to the SFP optical module and connected to other Ethernet terminal devices through the optical cable.

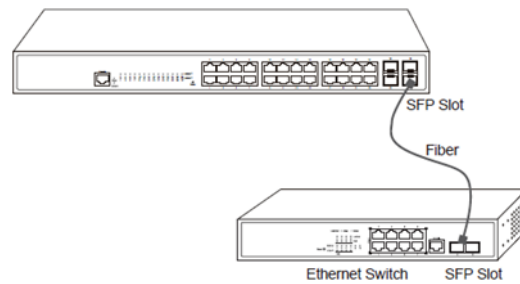

Figure 3-6 Gigabit SFP ports connect to other Ethernet terminal devices

3.3.3 Connecting 1000M Ethernet Base-T ports

24 SWITCH provides 24 10/100/1000MRJ45 ports. Each port corresponds to one LINK/ACT indicator. In use, the ports can connect other UT terminal devices through the UTP port and the direct-through or cross network cable. The numbering order of the pins in the UTP port is the same as the console port. See the following figure:

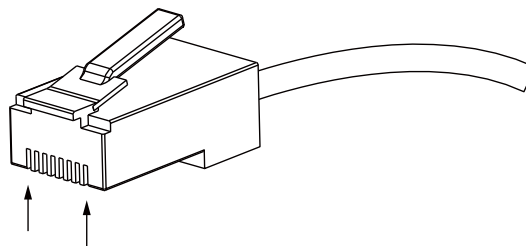

Figure3-7 RJ-45 Connector of the console port

Because 24 10/100/1000Base-T ports of 24 SWITCH support the MDI/MDIX self-identification of the cable, 24 SWITCH can adopt five types of direct-through/cross network cables when it connects other Ethernet terminals.

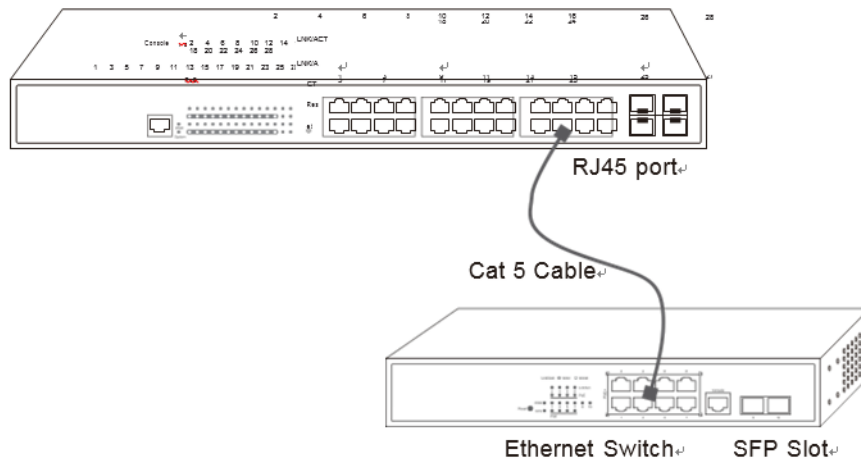

Figure 3-8 Connecting the 1000M Base-T port and other Ethernet terminals

No.	Pin name	Abbr.	Remarks
1	Sending the normal phase of the data	TXD1+	Output
2	Sending the paraphase of the data	TXD1-	Output
3	Receiving the normal phase of the data	RXD1+	Input
4	Sending the normal phase of the data	TXD2+	Output
5	Sending the paraphase of the data	TXD2-	Output
6	Receiving the normal phase of the data	RXD1-	Input
7	Receiving the normal phase of the data	RXD2+	Input
8	Sending the paraphase of the data	RXD1-	Input

Table 3-1 Pins of gigabit RJ45

The direct-through or cross network cable has the function of auto-identification, so the five classes of direct-through/cross network cables can be used to connect other Ethernet devices.

3.4 Checking After Installation

Before electrically starting up the switch, perform the following checkups after the switch is installed:

-
- If the switch is installed on the cabinet, check whether the installation point between the cabinet and the switch is strong. If the switch is installed on the desk, check whether there is enough space for the switch to discharge its heat and whether the desk is stable.
 - Check whether the connected power meets the power requirements of the switch.
 - Check whether the grounding line is correctly connected.
 - Check whether the switch is correctly connected to other terminal devices.

Chapter 4 Maintaining Switch

Caution:

- 1) Before opening the machine box, make sure that you have released the static you carried and then turn off the power on-off of the switch. Before operating any step in Appendix B, read the section “**Safety Advice**”.
- 2) Before performing operations beside the power source or on the machine box, turn off the power on-off and plug out the power cable.

4.1 Opening the Machine Box

This section describes how to open the cover of the switch, required tools and operation methods.

Caution:

When the power cable still connects the power supply, do not touch it.

When you open the cover the switch, you may use the following tools:

- Crossed screwdriver
- Static armguard

Perform the following steps to open the cover of the switch:

- (1) Turn off the power on-off of the switch.
- (2) Plug out all cables connected the back of the switch.
- (3) Take out the bolt from the machine box with the screwdriver.

Note:

The machine box comprises of two parts: cover and bottom.

- (4) Open the cover by holding two sides of the cover towards the direction of the arrow key shown in the following figure:

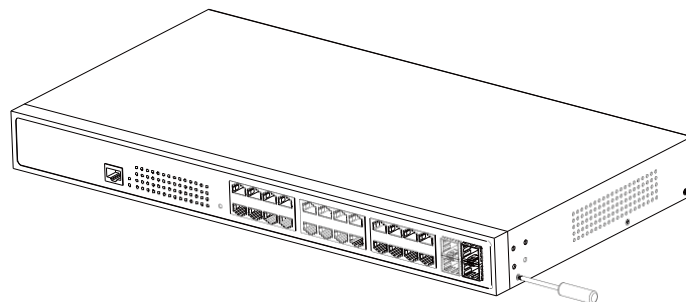

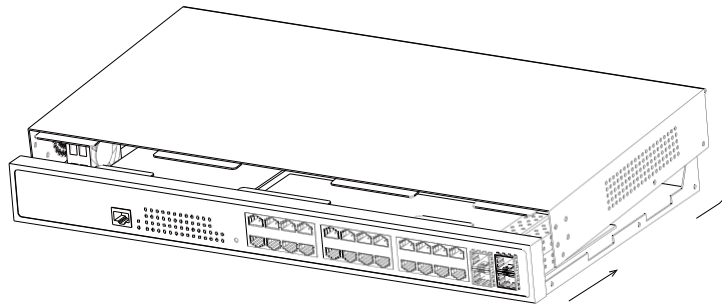

Figure 4-1 Opening the chassis of 24 SWITCH

- (5) When the cover is opened, put it aside. The mainboard of the system appears.

Note:

After taking off the cover, put it horizontally and avoid it to be crushed or collided. Otherwise, the machine box is hard to install.

4.2 Closing the Machine Box

The section mainly describes how to put the cover and close the machine box. Do as follows:

- (1) Put them well according to their locations and joint them together along their sides. See the following figure.

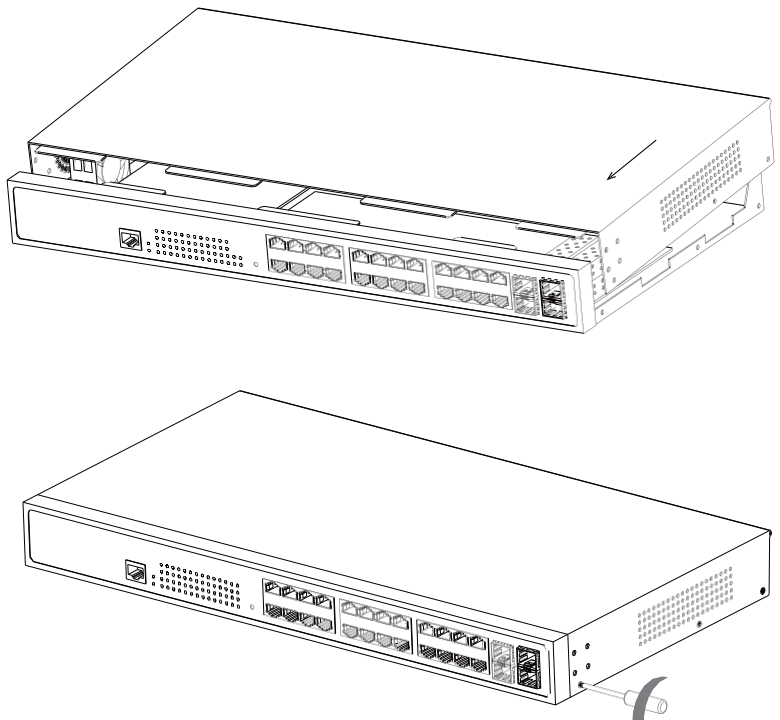

-
- (2) When the cover and the bottom are closely tied, let the cover slide the slot of the front template at the bottom.
 - (3) Nail the bolt and screw it tightly with the screwdriver.
 - (4) Reinstall the switch on the cabinet or the desk.
 - (5) Reconnect all cables of the switch.

Chapter 5 Hardware Fault Analysis

The part describes how to remove the fault from the switch.

5.1 Fault Separation

The key for resolving the systematic faults is to separate the fault from the system. You can compare what the system is doing with what the system should do to detect the fault. You need to check the following subsystems:

- Power and cooling systems—power and fan
- Port, cable and connection—ports on the front template of the switch and the cables connecting these ports

5.1.1 Faults Relative with Power and Cooling System

Do the following checkups to help remove the fault:

- When the power on-off is at the “ON” location, check whether the fan works normally. If the fan does not work well, check the fan.
- The working temperature of the switch is from 0 to 40 Celsius degrees. If the switch is too hot, check whether the air outlet and air inlet are clean and then do relative operations in section 2.3 “Requirements for Common Locations”.
- If the switch cannot be started and the PWR indicator is off, check the power.

5.1.2 Faults Relative with Port, Cable and Connection

Do the following checkups to help remove the fault:

- If the port of the switch cannot be linked, check whether the cable is correctly connected and whether the peer connection is normal.
- If the power on-off is at the “ON” location, check the power source and the power cable.
- If the console port does not work after the system is started up, check whether the console port is set to a baud rate of 9600 bps, eight data bits, no sum check bit, one stop bit and no traffic control.

5.2 Indicator Description

The following table shows the indicators of the 24 SWITCH and their description:

No.	Abbrev.	Name	Description
1	PWR	Power indicator	When the switch is powered on, the indicator is on.
2	SYS	System indicator	When the indicator is always on, the system is being started up. When the indicator flickers, the system works well.
3	LINK/ACT	Port indicator	If the indicator is on in orange: 10/100Mbps, If the indicator is on in green: 1000Mbps If the indicator is off, the port is not connected.

Table 5-1 Definition of 24 SWITCH Indicator

Copyright Claims

Without the written approval of the company, any person or group cannot transcribe, copy or change partial or all contents of this manual, and must not broadcast it in any manner.

Trademark claims

Trademarks, product names, service names and company names, which are written in this manual but do not belong to the company, belong to their owners respectively.

Disclaimer of warranty

provides no evident or hinted guarantee towards the contents of this manual. In no event, except for the company's breach of law, shall the company be liable for incidental, consequential, indirect or special damages of any kind or for loss of profits or revenue or loss of business arising out of or relating to this manual.

Note: Customer shall not be notified of this manual's content amendments.

Chapter 6 Specifications

Item	24 SWITCH
Backplane	56Gbps
Forwarding rate	42Mpps
MAC	8K
Ports	24 10/100/1000M Base-T ports+4 1000Base-X ports
Dimensions(WxDxH)(mm)	440*230*45
Consumption	<15W
Power supply	AC: 100V-240V, 50Hz±10%
Environment	Operating temperature/humidity: 0°C-45°C, 5%-95% non-condensing Storage temperature/humidity: -20°C-70°C; 5%-95% non-condensing
MAC exchange	Static configuration and dynamic MAC learning; MAC browsing and removal Configurable aging time of the MAC address; Limited number of learnable MAC addresses; MAC filtration
VLAN	4K VLAN; GVRP; QinQ; Private VLAN
STP	802.1D (STP), 802.1W (RSTP) and 802.1S (MSTP) BPDU protection, root protection, and loopback protection
Multicast	IGMP v1/v2/v3 IGMP snooping IGMP Fast Leave Multicast group strategy and quantity limitation Multicast flow copying over VLANs
QoS	Flow classification based on L2-4 protocols CAR flow limit 802.1P/DSCP priority re-labeling SP, WRR, and "SP+WRR" Congestion avoidance mechanisms like Tail-Drop and WRED

	Flow monitoring and flow shaping
Security	<p>L2/L3/L4 ACL flow identification and filtration</p> <p>DDoS attack prevention, TCP's SYN Flood attack prevention, UDP Flood attack prevention, etc</p> <p>Broadcast/multicast/unknown unicast storm-control</p> <p>Port isolation</p> <p>Port security, and "IP+MAC+port" binding</p>
Reliability	<p>Static/LACP link aggregation</p> <p>EAPS and ERPS</p>
Management	<p>Console, Telnet, SSH2.0, Web</p> <p>SNMP v1/v2/v3</p> <p>TFTP</p> <p>RMON</p>



First Choice for Security Professionals