



Explosion-Proof Network Bullet Camera

Quick Start Guide



© 2020 Hangzhou Hikvision Digital Technology Co., Ltd. All rights reserved.

This Manual is the property of Hangzhou Hikvision Digital Technology Co., Ltd. or its affiliates (hereinafter referred to as "Hikvision"), and it cannot be reproduced, changed, translated, or distributed, partially or wholly, by any means, without the prior written permission of Hikvision. Unless otherwise expressly stated herein, Hikvision does not make any warranties, guarantees or representations, express or implied, regarding to the Manual, any information contained herein.

About this Manual

The Manual includes instructions for using and managing the Product. Pictures, charts, images and all other information hereinafter are for description and explanation only. The information contained in the Manual is subject to change, without notice, due to firmware updates or other reasons. Please find the latest version of this Manual at the Hikvision website (<http://www.hikvision.com/>).

Please use this Manual with the guidance and assistance of professionals trained in supporting the Product.

Trademarks

HIKVISION and other Hikvision's trademarks and logos are the properties of Hikvision in various jurisdictions.

Other trademarks and logos mentioned are the properties of their respective owners.

Disclaimer



TO THE MAXIMUM EXTENT PERMITTED BY APPLICABLE LAW, THIS MANUAL AND THE PRODUCT DESCRIBED, WITH ITS HARDWARE, SOFTWARE AND FIRMWARE, ARE PROVIDED “AS IS” AND “WITH ALL FAULTS AND ERRORS”. HIKVISION MAKES NO WARRANTIES, EXPRESS OR IMPLIED, INCLUDING WITHOUT LIMITATION, MERCHANTABILITY, SATISFACTORY QUALITY, OR FITNESS FOR A PARTICULAR PURPOSE. THE USE OF THE PRODUCT BY YOU IS AT YOUR OWN RISK. IN NO EVENT WILL HIKVISION BE LIABLE TO YOU FOR ANY SPECIAL, CONSEQUENTIAL, INCIDENTAL, OR INDIRECT DAMAGES, INCLUDING, AMONG OTHERS, DAMAGES FOR LOSS OF BUSINESS PROFITS, BUSINESS INTERRUPTION, OR LOSS OF DATA, CORRUPTION OF SYSTEMS, OR LOSS OF DOCUMENTATION, WHETHER BASED ON BREACH OF CONTRACT, TORT (INCLUDING NEGLIGENCE), PRODUCT LIABILITY, OR OTHERWISE, IN CONNECTION WITH THE USE OF THE PRODUCT, EVEN IF HIKVISION HAS BEEN ADVISED OF THE POSSIBILITY OF SUCH DAMAGES OR LOSS.

YOU ACKNOWLEDGE THAT THE NATURE OF INTERNET PROVIDES FOR INHERENT SECURITY RISKS, AND HIKVISION SHALL NOT TAKE ANY RESPONSIBILITIES FOR ABNORMAL OPERATION, PRIVACY LEAKAGE OR OTHER DAMAGES RESULTING FROM CYBER-ATTACK, HACKER ATTACK, VIRUS INFECTION, OR OTHER INTERNET SECURITY RISKS; HOWEVER, HIKVISION WILL PROVIDE TIMELY TECHNICAL SUPPORT IF REQUIRED.

YOU AGREE TO USE THIS PRODUCT IN COMPLIANCE WITH ALL APPLICABLE LAWS, AND YOU ARE SOLELY RESPONSIBLE FOR ENSURING THAT YOUR USE CONFORMS TO THE APPLICABLE LAW. ESPECIALLY, YOU ARE RESPONSIBLE, FOR USING THIS PRODUCT IN A MANNER THAT DOES NOT INFRINGE ON THE RIGHTS OF THIRD



PARTIES, INCLUDING WITHOUT LIMITATION, RIGHTS OF PUBLICITY, INTELLECTUAL PROPERTY RIGHTS, OR DATA PROTECTION AND OTHER PRIVACY RIGHTS. YOU SHALL NOT USE THIS PRODUCT FOR ANY PROHIBITED END-USES, INCLUDING THE DEVELOPMENT OR PRODUCTION OF WEAPONS OF MASS DESTRUCTION, THE DEVELOPMENT OR PRODUCTION OF CHEMICAL OR BIOLOGICAL WEAPONS, ANY ACTIVITIES IN THE CONTEXT RELATED TO ANY NUCLEAR EXPLOSIVE OR UNSAFE NUCLEAR FUEL-CYCLE, OR IN SUPPORT OF HUMAN RIGHTS ABUSES.

IN THE EVENT OF ANY CONFLICTS BETWEEN THIS MANUAL AND THE APPLICABLE LAW, THE LATER PREVAILS.

Regulatory Information

FCC Information

Please take attention that changes or modification not expressly approved by the party responsible for compliance could void the user's authority to operate the equipment.

FCC compliance: This equipment has been tested and found to comply with the limits for a Class A digital device, pursuant to part 15 of the FCC Rules. These limits are designed to provide reasonable protection against harmful interference when the equipment is operated in a commercial environment. This equipment generates, uses, and can radiate radio frequency energy and, if not installed and used in accordance with the instruction manual, may cause harmful interference to radio communications. Operation of this equipment in a residential area is likely to cause harmful interference in which case the user will be required to correct the interference at his own expense.



FCC Conditions

This device complies with part 15 of the FCC Rules. Operation is subject to the following two conditions:

1. This device may not cause harmful interference.
2. This device must accept any interference received, including interference that may cause undesired operation.

EU Conformity Statement



This product and - if applicable - the supplied accessories too are marked with "CE" and comply therefore with the applicable harmonized

European standards listed under the EMC Directive 2014/30/EU, the LVD Directive 2014/35/EU, the RoHS Directive 2011/65/EU, the ATEX Directive 2014/34/EU.



2012/19/EU (WEEE directive): Products marked with this symbol cannot be disposed of as unsorted municipal waste in the European Union. For proper recycling, return this product to your local supplier

upon the purchase of equivalent new equipment, or dispose of it at designated collection points. For more information see:

www.recyclethis.info



2006/66/EC (battery directive): This product contains a battery that cannot be disposed of as unsorted municipal waste in the European Union. See the product documentation for specific battery information. The battery is marked with this symbol,

which may include lettering to indicate cadmium (Cd), lead (Pb), or mercury (Hg). For proper recycling, return the battery to your



supplier or to a designated collection point. For more information see: www.recyclethis.info

Intended use of the camera

ATEX:  II 2 G D Ex db IIC T6 Gb/Ex tb IIIC T80°C Db IP68

IECEX: Ex db IIC T6 Gb/Ex tb IIIC T80°C Db IP68

Hazardous Area Classification: Zone 1, Zone 2, Zone 21, Zone 22.

IP Degree: IP68 (2m, 2h)

Ex Standards:

IEC 60079-0: 2011 EN 60079-0: 2012

IEC 60079-1: 2014 EN 60079-1: 2014

IEC 60079-31: 2013 EN 60079-31: 2014

Nameplate:

Explosion-Proof Network Bullet Camera		Explosion-Proof Sign:
Product Model: DS-2XE62x2F-IS		 II 2 G Ex db IIC T6 Gb
Protection Level: IP68(2m/2h)	Temperature: -30°C~ +60°C	 II 2 D Ex tb IIIC T80°C Db
Working Voltage: AC100~240V	Working Current: ≤1000mA	Explosion-Proof Certificate No.:
Product No.: xxxxxxxxxxxx	Date of Production: xxxxxx	TÜV 16 ATEX 7946X
Hikvision Digital Technology Co., Ltd 555 Qianmo Road, Binjiang District, Hangzhou, China		IECEX TUR 16.0047X 

Special Conditions for Safe Use:

1. Ambient Temperature: -30 °C to +60 °C.
2. DO NOT OPEN WHEN ENERGIZED.



3. POTENTIAL ELECTROSTATIC CHARGING HAZARD – SEE INSTRUCTIONS.
4. When assembly, operation and maintenance, the operator must follow the requirements of the IEC 60079-14: latest version Explosive atmosphere- Part 14: Electrical installation design, selection and erection, beside of the manufacturer's operation instruction or its National equivalent.
5. Repair and overhaul shall comply with IEC 60079-19: latest version or its National equivalent.

Industry Canada ICES-003 Compliance

This device meets the CAN ICES-3 (A)/NMB-3(A) standards requirements.

Warning:

This is a class A product. In a domestic environment this product may cause radio interference in which case the user may be required to take adequate measures.

Safety Instruction



These instructions are intended to ensure that user can use the product correctly to avoid danger or property loss.

The precaution measure is divided into “Warnings” and “Cautions”

Warnings: Serious injury or death may occur if any of the warnings are neglected.

Cautions: Injury or equipment damage may occur if any of the cautions are neglected.



 Warnings	 Cautions
Warnings Follow these safeguards to prevent serious injury or death.	Cautions Follow these precautions to prevent potential injury or material damage.



Warnings

- CAUTION: Hot parts! Burned fingers when handling the parts.



Wait one-half hour after switching off before handling parts. This sticker is to indicate that the marked item can be hot and should not be touched without taking care. For device with this sticker, this device is intended for installation in a restricted access location, access can only be gained by service persons or by users who have been instructed about the reasons for the restrictions applied to the location and about any precautions that shall be taken.

- Grounding:

The both internal and external earthing shall be connected reliably.

Ground wire cross-sectional area of not less than the phase connector cross-sectional area level, at least 4 mm².



- All the electrical operation should be strictly compliance with the electrical safety regulations, fire prevention regulations and other related regulations of the nation and region.
- Make sure that the power has been disconnected before you wire, install or disassemble the camera. Never wire, install or disassemble the camera in explosive environment.
- The power source should meet limited power source or PS2 requirements according to IEC 60950-1 or IEC 62368-1 standard.
- Do not connect several devices to one power adapter as adapter overload may cause over-heating or a fire hazard.
- To avoid fire danger caused by electrostatic charge, never touch or wipe the camera in explosive environment. Perform the wiping and replacing accessories only under non-explosive environment with the provided glove.
- When the camera is installed on wall or ceiling, the device shall be firmly fixed.
- If smoke, odors or noise rise from the camera, turn off the power at once and unplug the power cable, and then contact the service center.
- If the camera does not work properly, contact your dealer or the nearest service center. Never attempt to disassemble the speed dome yourself. (We shall not assume any responsibility for problems caused by unauthorized repair or maintenance.)



Cautions



- Make sure the power supply voltage is correct before using the camera.
- Do not drop the camera or subject it to physical shock.
- To ensure explosion-proof performance, do not damage explosion-proof surface.
- Do not touch sensor modules with fingers. If cleaning is necessary, use clean cloth with a bit of ethanol and wipe it gently. If the camera will not be used for an extended period, please replace the lens cap to protect the sensor from dirt.
- Do not aim the camera at the sun or extra bright places. Blooming or smearing may occur otherwise (which is not a malfunction), and affect the endurance of sensor at the same time.
- The sensor may be burned out by a laser beam, so when any laser equipment is in using, make sure that the surface of sensor will not be exposed to the laser beam.
- Do not place the camera in extremely hot, cold (the operating temperature shall be $-30\text{ }^{\circ}\text{C}$ to $+60\text{ }^{\circ}\text{C}$), dusty or damp locations, and do not expose it to high electromagnetic radiation.
- To avoid heat accumulation, good ventilation is required for operating environment.
- To prevent accumulation of electrostatic charge, only damp cloth can be used during the cleaning.
- Keep the camera away from liquid while in use.
- While in delivery, the camera shall be packed in its original packing, or packing of the same texture.



- Regular part replacement: a few parts (e.g. electrolytic capacitor) of the equipment shall be replaced regularly according to their average enduring time. The average time varies because of differences between operating environment and using history, so regular checking is recommended for all the users. Please contact with your dealer for more details.
- Improper use or replacement of the battery may result in hazard of explosion. Replace with the same or equivalent type only. Dispose of used batteries according to the instructions provided by the battery manufacturer.
- CAUTION: Risk of explosion if the battery is replaced by an incorrect type. Dispose of used batteries according to the instructions

ATTENTION: IL Y A RISQUE D'EXPLOSION SI LA BATTERIE EST REMPLACÉE PAR UNE BATTERIE DE TYPE INCORRECT. METTRE AU REBUT LES BATTERIES USAGÉES CONFORMÉMENT AUX INSTRUCTIONS

- Improper replacement of the battery with an incorrect type may defeat a safeguard (for example, in the case of some lithium battery types).
- Do not dispose of the battery into fire or a hot oven, or mechanically crush or cut the battery, which may result in an explosion.
- Do not leave the battery in an extremely high temperature surrounding environment, which may result in an explosion or the leakage of flammable liquid or gas.



- Do not subject the battery to extremely low air pressure, which may result in an explosion or the leakage of flammable liquid or gas.
- If the product does not work properly, please contact your dealer or the nearest service center. Never attempt to disassemble the camera yourself. (We shall not assume any responsibility for problems caused by unauthorized repair or maintenance.)



Table of Contents

1 Introduction	13
1.1 Overview.....	13
1.2 Model Description.....	13
2 Appearance Description	15
2.1 Overview.....	15
2.2 Cable Description	16
3 Installation	18
4 Activate and Access Network Camera	22



1 Introduction

1.1 Overview

Explosion-proof network camera is a surveillance product capable of video/audio collecting, smart encoding and network transmitting. It adopts an embedded system and a high-performed hardware process platform to achieve good stability and reliability.

You can visit and configure your camera via web browser and client software.

Explosion-proof network camera adopts a stainless steel enclosure, receiving an IP68 rating for ingress protection.

Application Scenarios: oil industry, mine fields, chemical industry, port, grain processing industry, etc.

1.2 Model Description

This manual is applicable to the following models:

Table 1-1 Applicable Model List

Model List
DS-2XE6212F-IS
DS-2XE6222F-IS
DS-2XE6232F-IS
DS-2XE6242F-IS
DS-2XE6252F-IS
DS-2XE6262F-IS
DS-2XE6282F-IS



Explanation of model naming:

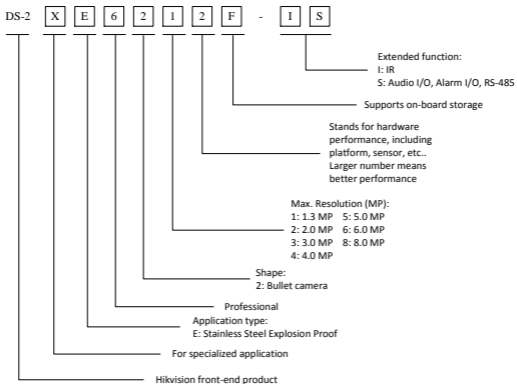

Figure 1-1 Model Explanation



2 Appearance Description

2.1 Overview

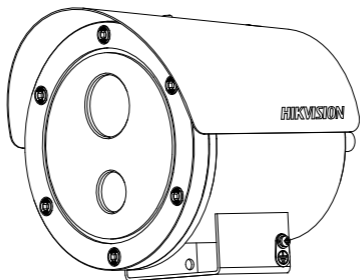

Figure 2-1 Explosion-Proof Network Bullet Camera Overview (1)

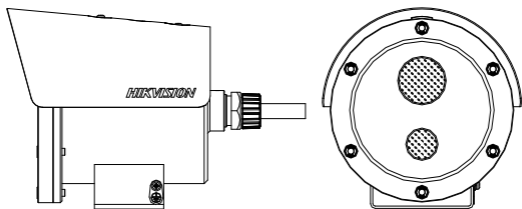

Figure 2-2 Explosion-Proof Network Bullet Camera Overview (2)



2.2 Cable Description

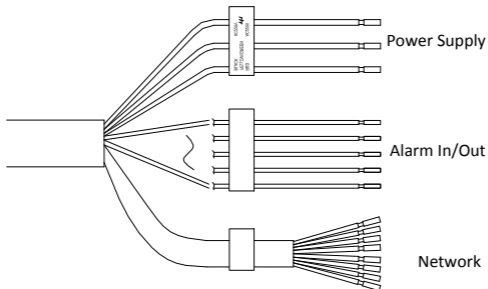

Figure 2-3 Overview of Cables

Table 2-1 Description of Cables

Cables	Description
Power Supply	Voltage: 100 VAC to 240 VAC
	YELLOW/GREEN: for grounding
Alarm In/Out	YELLOW/BLUE: ALARM_IN1
	WHITE/RED: ALARM_OUT1
	YELLOW/ORANGE: ALARM_IN2
	WHITE/PURPLE: ALARM_OUT2
	YELLOW/BLACK: ALARM_GND



Cables	Description
Network	For network communication

Note:

ALARM_IN1 and ALARM_OUT1 (ALARM_IN2 and ALARM_OUT2) should be used in pairs for alarm input and output.



3 Installation

Before you start:

- Make sure the device in the package is in good condition and all the assembly parts are included.
- The standard power supply is 100 VAC to 240 VAC, please make sure your power supply matches with your camera.
- Make sure all the related equipment is power-off during the installation.
- Check the specification of the products for the installation environment.
- Make sure that the wall is strong enough to withstand four times the weight of the camera and the bracket.

For the camera that supports IR, you are required to pay attention to the following precautions to prevent IR reflection:

- Make sure that there is no reflective surface too close to the camera lens. The IR light from the camera may reflect back into the lens causing reflection.

Wall Mounting

Before you start:

There is no wall mounting bracket included in the package. You have to prepare a wall mounting bracket if you choose this mounting type. The shown bracket below is only for demonstration.

Steps:

1. Fix the wall mounting bracket to the desired place on wall with four expansion screws.

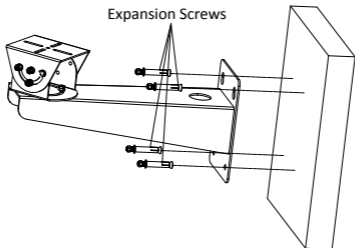

Figure 3-1 Install the Wall Mounting Bracket

2. Unscrew and remove the pedestal from the bracket.

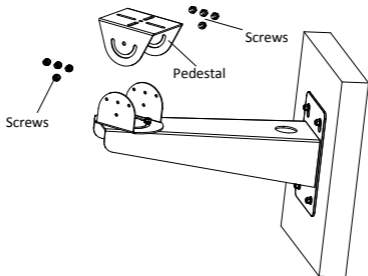

Figure 3-2 Remove the Pedestal

3. Align the screw holes on the camera mounting base with those on the pedestal, and fix the camera to the pedestal with the supplied screws.

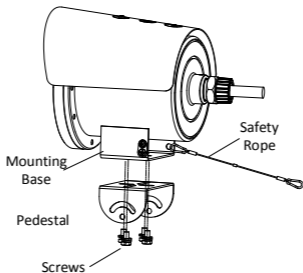

Figure 3-3 Fix the Camera to the Pedestal

4. Loosen the fixing screw, and adjust the panning position. Tighten the fixing screw after adjustment.

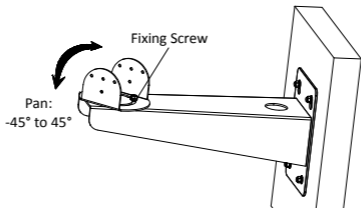

Figure 3-4 Adjust Panning Position

5. Use safety rope to hook the camera and the bracket. Adjust the tilting position when screwing the camera to the wall mounting bracket.

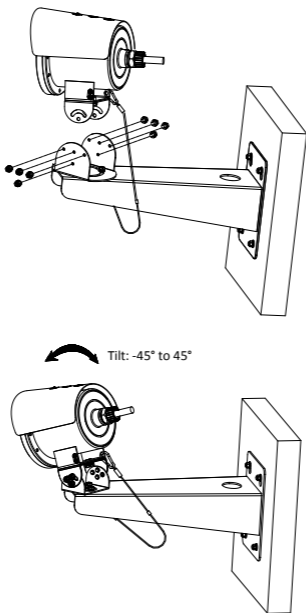

Figure 3-5 Secure the Camera to Wall Mounting Bracket

6. Secure the screws to finish installation.



4 Activate and Access Network Camera

Scan the QR code to get *Activate and Access Network Camera*. Note that mobile data charges may apply if Wi-Fi is unavailable.



