

# HIKVISION



Handheld **Thermal** Monocular

## User Manual

## About This Manual

COPYRIGHT ©2018 Hangzhou Hikvision Digital Technology Co., Ltd.

### ALL RIGHTS RESERVED.

Any and all information, including, among others, wordings, pictures, graphs are the properties of Hangzhou Hikvision Digital Technology Co., Ltd. or its subsidiaries (hereinafter referred to be "Hikvision"). This user manual (hereinafter referred to be "the Manual") cannot be reproduced, changed, translated, or distributed, partially or wholly, by any means, without the prior written permission of Hikvision. Unless otherwise stipulated, Hikvision does not make any warranties, guarantees or representations, express or implied, regarding to the Manual.

This Manual is applicable to **Handheld Thermal Monocular**.

The Manual includes instructions for using and managing the product. Pictures, charts, images and all other information hereinafter are for description and explanation only. The information contained in the Manual is subject to change, without notice, due to firmware updates or other reasons. Please find the latest version in the company website (<http://overseas.hikvision.com/en/>).

Please use this user manual under the guidance of professionals.

### Trademarks Acknowledgement

**HIKVISION** and other Hikvision's trademarks and logos are the properties of Hikvision in various jurisdictions. Other trademarks and logos mentioned below are the properties of their respective owners.

## Legal Disclaimer

TO THE MAXIMUM EXTENT PERMITTED BY APPLICABLE LAW, THE PRODUCT DESCRIBED, WITH ITS HARDWARE, SOFTWARE AND FIRMWARE, IS PROVIDED "AS IS", WITH ALL FAULTS AND ERRORS, AND HIKVISION MAKES NO WARRANTIES, EXPRESS OR IMPLIED, INCLUDING WITHOUT LIMITATION, MERCHANTABILITY, SATISFACTORY QUALITY, FITNESS FOR A PARTICULAR PURPOSE, AND NON-INFRINGEMENT OF THIRD PARTY. IN NO EVENT WILL HIKVISION, ITS DIRECTORS, OFFICERS, EMPLOYEES, OR AGENTS BE LIABLE TO YOU FOR ANY SPECIAL, CONSEQUENTIAL, INCIDENTAL, OR INDIRECT DAMAGES, INCLUDING, AMONG OTHERS, DAMAGES FOR LOSS OF BUSINESS PROFITS, BUSINESS INTERRUPTION, OR LOSS OF DATA OR DOCUMENTATION, IN CONNECTION WITH THE USE OF THIS PRODUCT, EVEN IF HIKVISION HAS BEEN ADVISED OF THE POSSIBILITY OF SUCH DAMAGES.

REGARDING TO THE PRODUCT WITH INTERNET ACCESS, THE USE OF PRODUCT SHALL BE WHOLLY AT YOUR OWN RISKS. HIKVISION SHALL NOT TAKE ANY RESPONSIBILITIES FOR ABNORMAL OPERATION, PRIVACY LEAKAGE OR OTHER DAMAGES RESULTING FROM CYBER ATTACK, HACKER ATTACK, VIRUS INSPECTION, OR OTHER INTERNET SECURITY RISKS; HOWEVER, HIKVISION WILL PROVIDE TIMELY TECHNICAL SUPPORT IF REQUIRED.

SURVEILLANCE LAWS VARY BY JURISDICTION. PLEASE CHECK ALL RELEVANT LAWS IN YOUR JURISDICTION BEFORE USING THIS PRODUCT IN ORDER TO ENSURE THAT YOUR USE CONFORMS THE APPLICABLE LAW. HIKVISION SHALL NOT BE LIABLE IN THE EVENT THAT THIS PRODUCT IS USED WITH ILLEGITIMATE PURPOSES.

IN THE EVENT OF ANY CONFLICTS BETWEEN THIS MANUAL AND THE APPLICABLE LAW, THE LATER PREVAILS.

## Regulatory Information

### FCC Information

Please take attention that changes or modification not expressly approved by the party responsible for compliance could void the user's authority to operate the equipment.

**FCC compliance:** This equipment has been tested and found to comply with the limits for a Class B digital device, pursuant to part 15 of the FCC Rules. These limits are designed to provide reasonable protection against harmful interference in a residential installation. This equipment generates, uses and can radiate radio frequency energy and, if not installed and used in accordance with the instructions, may cause harmful interference to radio communications. However, there is no

guarantee that interference will not occur in a particular installation. If this equipment does cause harmful interference to radio or television reception, which can be determined by turning the equipment off and on, the user is encouraged to try to correct the interference by one or more of the following measures:

- Reorient or relocate the receiving antenna.
- Increase the separation between the equipment and receiver.
- Connect the equipment into an outlet on a circuit different from that to which the receiver is connected.
- Consult the dealer or an experienced radio/TV technician for help.

This equipment should be installed and operated with a minimum distance 20cm between the radiator and your body.

#### FCC Conditions

This device complies with part 15 of the FCC Rules. Operation is subject to the following two conditions:

1. This device may not cause harmful interference.
2. This device must accept any interference received, including interference that may cause undesired operation

#### EU Conformity Statement



This product and, if applicable, the supplied accessories are marked with "CE" and comply therefore with the applicable harmonized European standards listed under the Radio Equipment Directive 2014/53/EU, the EMC Directive 2014/30/EU, the RoHS Directive

2011/65/EU.



2012/19/EU (WEEE directive): Products marked with this symbol cannot be disposed of as unsorted municipal waste in the European Union. For proper recycling, return this product to your local supplier upon the purchase of equivalent new equipment, or dispose of it at designated collection points. For more information see: [www.recyclethis.info](http://www.recyclethis.info).



2006/66/EC (battery directive): This product contains a battery that cannot be disposed of as unsorted municipal waste in the European Union. See the product documentation for specific battery information. The battery is marked with this symbol, which may include lettering to indicate cadmium (Cd), lead (Pb),

or mercury (Hg). For proper recycling, return the battery to your supplier or to a designated collection point. For more information see: [www.recyclethis.info](http://www.recyclethis.info).

#### Industry Canada ICES-003 Compliance

This device meets the CAN ICES-3 (B)/NMB-3(B) standards requirements.

This device complies with Industry Canada licence-exempt RSS standard(s). Operation is subject to the following two conditions:

- (1) this device may not cause interference, and
- (2) this device must accept any interference, including interference that may cause undesired operation of the device.

Le présent appareil est conforme aux CNR d'Industrie Canada applicables aux appareils radioexempts de licence.

L'exploitation est autorisée aux deux conditions suivantes :

- (1) l'appareil ne doit pas produire de brouillage, et
- (2) l'utilisateur de l'appareil doit accepter tout brouillage radioélectrique subi, même si le brouillage est susceptible d'en compromettre le fonctionnement.

Under Industry Canada regulations, this radio transmitter may only operate using an antenna of a type and maximum (or lesser) gain approved for the transmitter by Industry Canada. To reduce potential radio interference to other users, the antenna type and its gain should be so chosen that the equivalent

isotropically radiated power (e.i.r.p.) is not more than that necessary for successful communication.

Conformément à la réglementation d'Industrie Canada, le présent émetteur radio peut fonctionner avec une antenne d'un type et d'un gain maximal (ou inférieur) approuvé pour l'émetteur par Industrie Canada. Dans le but de réduire les risques de brouillage radioélectrique à l'intention des autres utilisateurs, il faut choisir le type d'antenne et son gain de sorte que la puissance isotrope rayonnée équivalente (p.i.r.e.) ne dépasse pas l'intensité nécessaire à l'établissement d'une communication satisfaisante.

This equipment should be installed and operated with a minimum distance 20cm between the radiator and your body.

Cet équipement doit être installé et utilisé à une distance minimale de 20 cm entre le radiateur et votre corps.

## WARNINGS AND CAUTIONS

- All the electronic operation should be strictly compliance with the electrical safety regulations, fire prevention regulations and other related regulations in your local region.
- Please use the power adapter, which is provided by normal company. The power consumption cannot be less than the required value.
- Do not connect several devices to one power adapter as adapter overload may cause over-heat or fire hazard.
- Do not drop the device or subject it to physical shock, and do not expose it to high electromagnetism radiation. Avoid the device installation on vibrations surface or places subject to shock (ignorance can cause equipment damage).
- Do not place the device in extremely hot (refer to the specification of the device for the detailed operating temperature), cold, dusty or damp locations, and do not expose it to high electromagnetic radiation.
- The device cover for indoor use should be kept from rain and moisture.
- Exposing the device to direct sun light, low ventilation or heat source such as heater or radiator is forbidden (ignorance can cause fire danger).
- Do not aim the device at the sun or extra bright places. A blooming or smear may occur otherwise (which is not a malfunction however), and affecting the endurance of sensor at the same time.

For long-term storage of the battery, make sure you fully charge it every half year, to ensure the battery quality. Otherwise, you may damage the battery.

SAVE THIS MANUAL FOR FUTURE REFERENCE

# 1 Introduction

## 1.1 Box Content



USB Cable  
(x1)



Manual (x1)



Non-dust  
Cloth (x1)



Protective  
Bag (x1)



Handheld Thermal  
Monocular (x1)



Neck  
Belt(x1)

## 1.2 Overview

The handheld thermal monocular is a handheld thermal camera with functions of observation, hot spot mark, distance measurement, Wi-Fi hot spot, and so on. The high-sensitivity built-in IR detector provides you with clear view even in total darkness.

## 1.3 Features

- High performance chip, and DDE (Digital Detail Enhancement) technique
- 1024 × 768 Resolution OLED display
- Built-in rechargeable Li-ion battery
- Up to five hours continuous running (GPS function and Wi-Fi hot spot function off)
- USB Cable
- Small in size and light in weight

## 1.4 Functions

Distance Measurement:

The device realizes distance measurement function after marking the top and bottom of target, and input the target height.

Hot Spot Mark:

The device detects and marks the hot spot of highest temperature.

#### Wi-Fi & Hot Spot:

Device can capture snapshots, record videos, and set parameters via APP after being connected to your phone.

#### GPS Function:

The device can be located with GPS system.

#### Mode Switch:

Device supports pallet switch and distance measurement.

#### Storage:

Built-in memory module supports video recording/snapshot capturing.

#### Digital Zoom:

Device supports 1× and 2× digital zoom.

#### LED Light:

LED light supplement makes the device a torch in the wild field.

*Note:* the function may not be supported by some camera models.

## 2 Appearance

### 2.1 Dimensions

Take the figure below for the dimensions of the handheld thermal monocular.

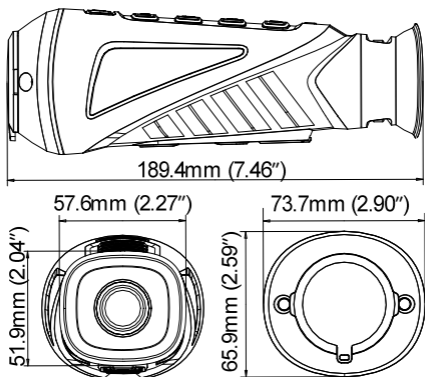

Note: the dimension varies according to different camera modes.

## 2.2 Buttons and Interfaces

Take the figure below for the buttons and interfaces description of handheld thermal monocular.

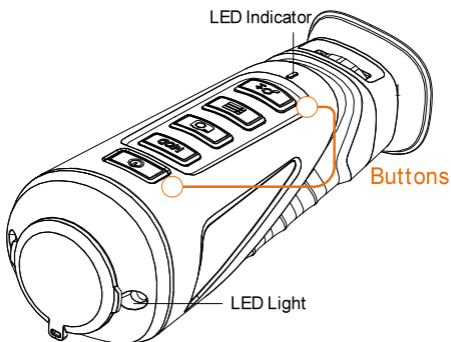

Power

Press: LED Light Supplement On/Off. The function may not be supported by some camera models

Hold: Power On/Off



MODE

Press: Switch Pallet

Hold: Distance Measure On/Off



Capture

Press: Capture Snapshot

Hold: Start/Stop Record Video



Menu

Press: Shutter Release

Hold: Menu Operation



Zoom  $\pm$

Press: Digital Zoom

Hold: Reserved

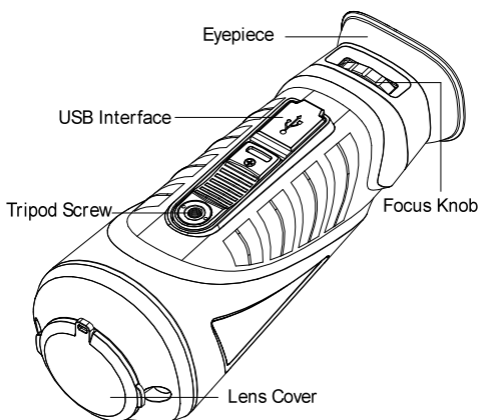

Lens Cover	Cover the lens when you are not using the monocular.
LED Indicator	When the LED indicator is on: the device is activating.
Sight Adjust Knob	Slide the sight adjust knob to adjust the view according to your degree of myopia.
USB Interface	Charge the battery and export videos/snapshots with the USB cable.

*Note:* For detailed operations of the menu, refer to **Menu Operation Section**.

## 3 Basic Operations

### 3.1 Charging the Monocular

*Note:* Please charge the monocular with the delivered USB cable and power adapter. The charging temperature should be 0 °C to 45 °C (32 °F to 113 °F).

*Steps:*

1. Lift the USB cover.



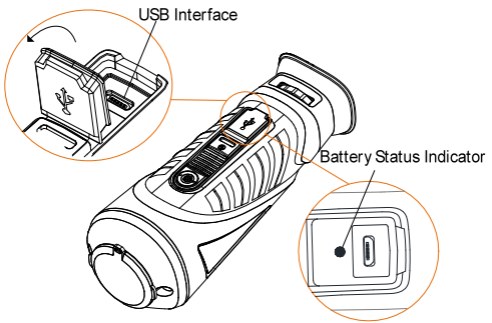

2. Plug in the USB cable and connect the other terminal into the power adapter.
3. Plug the power adapter to the power source.

When the monocular is turned on, the OSD (on-screen display) shows the battery status. When you see the Low Battery status, charge the monocular and ensure it's working properly.

#### Battery LED Indicator Status

- |               |                              |
|---------------|------------------------------|
| Red Flash     | Error occurred.              |
| ● Solid Red   | Battery is properly charged. |
| ● Solid Green | Battery is fully charged.    |
| ● Off         | Battery is not charged.      |

## 3.2 Power On and Off

### Power On

Hold the POWER button for four seconds and the LED indicator in the front turns green. After the device is powered on, the indicator keeps green.

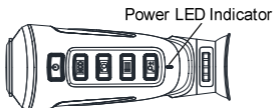

Refer to the figure below for the main view of the monocular.



### Power Off

When the monocular is turned on, hold the POWER button for four seconds to power off the device.

## 3.3 Thermal View Observation

*Steps:*

1. Power on the monocular.
2. Hold the monocular and make sure the eyepiece covers your eye.

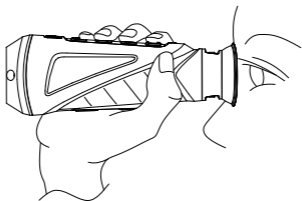

3. Slide the sight adjust knob to adjust the diopter until the OSD text or image is clear.

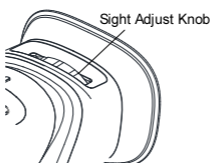





*Note:* You must perform the sight adjustment before any further use of the monocular.

4. Point the monocular towards the target of the view.

## 3.4 Basic Operation

Connect the thermal monocular to your PC with USB cable, you can export the recorded videos and captured snapshots.

*Steps:*

1. Hold the  button to enter the menu and select the icon .
2. Press  and the icon turns to  and the Wi-Fi hot spot function is disabled.
3. Connect the thermal monocular to your PC with USB cable, you can see a detected removable disk.

*Notes:*

- When you connect the device to PC for the first time, it installs the drive program automatically.
- When you connect the device to PC, the device displays images, but functions such as recording, capturing and Wi-Fi hot spot are disabled.

File Export

*Steps:*

1. Connect the thermal monocular to your PC with USB cable and open the detected disk.
2. Enter DCIM>100EZVIZ to view the videos and snapshots.
  - Select and copy the videos to PC and play the file with the player.
  - Select and copy the snapshots to PC and view the files.
3. Disconnect the device from your PC.

## Upgrade

### Steps:



1. Connect the thermal monocular to your PC with USB cable and open the detected disk.
2. Copy the upgrade file and paste it to the root directory of the device.
3. Disconnect the device from your PC.
4. Reboot the monocular and the device upgrades automatically. The upgrading process will be displayed in the main interface.

# 4 Main Function

## 4.1 Menu Operation

When the monocular is turned on, hold the button  for three seconds to display the OSD menu.



Press the button  to move the cursor up, and press the button  to move the cursor down. Press the button  to confirm.



Press  to display or hide the OSD information.



Press  to enable/disable hot spot mark (marking the spot of highest temperature).



Press  to enable or disable the Wi-Fi and hot spot. Connect your phone to the monocular via the Wi-Fi

---

or hot spot and record/capture with App.

---



Press  to enter distance measurement mode. For details, refer to Section 4.2 Distance Measurement.

---



Press  to enable or disable the GPS function.

---

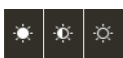

Press  to adjust the brightness. The icons on the left indicate: high Brightness, medium Brightness, and low Brightness.

---



Press  to view the version number and serial number.

---



Press  to restore all parameters to default settings.

---

## Palette Settings

Under the same scene, you can select different palettes to see the scene in different effects.

---

White Hot:

The hot part is light-colored in view.



Black Hot:

The hot part is black-colored in view.



Fusion:

The hot part is yellow-colored and cold part is purple-colored in view.





Red Hot:

The hot part is red-colored in view.



## Brightness Adjusting

In white hot mode, you can adjust the brightness as  >  >  to adjust the image darker and darker.



In black hot mode, the brightness of the image turns in the opposite way.

## 4.2 Distance Measurement

*Before you start:*









In the view mode, you can hold the  button to enter the distance measurement mode.

Or, you can hold the  button to enter the menu and select  to enter the distance measurement mode.



*Purpose:*

You can mark the top and bottom of the target in the distance to calculate the distance in between.

*Steps:*

1. Enter the distance measurement mode. You can refer to *Before you start* part above.
2. Define the target height.
  - a) Press  to enter the height setting interface.
  - b) Press  and  to select the target from Deer, Wolf, Bear, and Custom.
  - c) Press  to confirm.
  - d) Press  and  to select the target height.
  - e) Press  to confirm.
3. Set the top of the target.
  - a) Move the monocular slightly to place the  mark above the target top.
  - b) Press  to confirm.



4. Set the bottom of the target.
  - a) Move the monocular slightly to place the  mark below the target bottom.
  - b) Press  to confirm.



The distance between you and the target will display on the upper left



corner of the live view interface.



*Note:* Enter the distance measurement interface, press  to view the measured distance.

### 4.3 Hot Spot Mark

In the menu, select  and press  to enable/disable hot spot mark (marking the spot of highest temperature).

When the hot spot mark is enabled, the  mark displays in the spot of the highest temperature. When the scene changes, the  mark moves.

### 4.4 Record/Capture

Video Recording

In the view mode, hold the  button for three seconds, and the monocular starts to record. In the upper left corner, the recording time displays.



After recording the video, hold the  button for three seconds again, and the monocular stops recording.

Snapshot Capturing

In the view mode, press the  button, the live view freezes for one second, and the snapshot is captured.

### 4.5 Digital Zoom

Press the  button in the view mode, the live view will switch between 1× digital zoom and 2× digital zoom.

### 4.6 Shutter Release

In the view mode, press the  button



once to release the shutter once.

## 4.7 Network Configuration

Connect your phone to the Wi-Fi or hot spot of the monocular, you can configure the parameters and realize functions of the device.



Wi-Fi

Steps:

1. Hold the  button to show the menu of monocular.
2. Press the  key to enable Wi-Fi function.
3. Setting the Wi-Fi name and password of your phone or the router as follow:
  - Wi-Fi Name: WLAN-IPTP.
  - Wi-Fi Password: abcd1234.
4. Search the “**IVMS-4500**” on App Store (iOS System) or Google Play™ (Android System) to download and install the app.
5. Open the APP and connect your phone with the device. You can view the interface of monocular on your phone.

Hot Spot

Steps:

1. Hold the  button to show the menu of monocular.
2. Press the  key to enable hot spot function.
3. Turn on the WLAN and connect to the hot spot.
  - Hot Spot Name: HIK-IPTS Serial No.
  - Hot Spot Password: S + serial No.
4. Search the “**IVMS-4500**” on App Store (iOS System) or Google Play™ (Android System) to download and install the app.
5. Open the APP and connect your phone with the device. You can view the interface of monocular on your phone.

## 4.8 Others

LED Light Supplement

Press the  button to enable/disable the LED light supplement.

*Note:* the function may not be supported by some camera models.

## 5 FAQ

**Q:** The charge indicator flashes improperly.

**A:** Examine whether the device is charged with standard power adapter and the charging temperature is 0 °C to 45 °C (32 °F to 113 °F).

**Q:** Device power indicator is off.

**A:** Examine whether the device is off-battery.

**Q:** The image of the monocular is not clear.

**A:** Perform the sight adjustment referring to section 3.3.

**Q:** Wi-Fi is not found.

**A:** Examine whether the Wi-Fi function is turned on. If not, go to OSD menu and turn on Wi-Fi.

**Q:** Capturing or recording fails.

**A:** Examine the items below:

1. Whether the device is connected to your PC and disabled the capturing and recording.
2. Whether the storage space is full.
3. Whether the device is low-battery.

**Q:** There is no GPS signal.

**A:** Examine the using environment. If the device receives no signal in indoor environment, please go to outdoor spaces. It takes about 10 min to power on and search for the signal.

**Q:** The PC cannot identify the monocular.

**A:** Examine the items below:

1. Whether the device is connected to your PC with standard USB cable.
2. If you use other USB cables, make sure the cable length is no longer than 1m.
3. Whether the Wi-Fi function is turned on. If so, go to OSD menu and turn off Wi-Fi.