

**HIKVISION**



**Thermal & Optical Bi-spectrum  
Network Bullet Camera**

Quick Start Guide

## **Quick Start Guide**

COPYRIGHT ©2019 Hangzhou Hikvision Digital Technology Co., Ltd.

### **ALL RIGHTS RESERVED.**

Any and all information, including, among others, wordings, pictures, graphs are the properties of Hangzhou Hikvision Digital Technology Co., Ltd. or its subsidiaries (hereinafter referred to be “Hikvision”). This user manual (hereinafter referred to be “the Manual”) cannot be reproduced, changed, translated, or distributed, partially or wholly, by any means, without the prior written permission of Hikvision. Unless otherwise stipulated, Hikvision does not make any warranties, guarantees or representations, express or implied, regarding to the Manual.

### **About this Manual**

This Manual is applicable to **Thermal & Optical Bi-spectrum Network Bullet Camera**.

The Manual includes instructions for using and managing the product. Pictures, charts, images and all other information hereinafter are for description and explanation only. The information contained in the Manual is subject to change, without notice, due to firmware updates or other reasons. Please find the latest version in the company website (<http://overseas.hikvision.com/en/>).

Please use this user manual under the guidance of professionals.

### **Trademarks Acknowledgement**

**HIKVISION** and other Hikvision’s trademarks and logos are the properties of Hikvision in various jurisdictions. Other trademarks and

logos mentioned below are the properties of their respective owners.

### **Legal Disclaimer**

TO THE MAXIMUM EXTENT PERMITTED BY APPLICABLE LAW, THE PRODUCT DESCRIBED, WITH ITS HARDWARE, SOFTWARE AND FIRMWARE, IS PROVIDED "AS IS", WITH ALL FAULTS AND ERRORS, AND HIKVISION MAKES NO WARRANTIES, EXPRESS OR IMPLIED, INCLUDING WITHOUT LIMITATION, MERCHANTABILITY, SATISFACTORY QUALITY, FITNESS FOR A PARTICULAR PURPOSE, AND NON-INFRINGEMENT OF THIRD PARTY. IN NO EVENT WILL HIKVISION, ITS DIRECTORS, OFFICERS, EMPLOYEES, OR AGENTS BE LIABLE TO YOU FOR ANY SPECIAL, CONSEQUENTIAL, INCIDENTAL, OR INDIRECT DAMAGES, INCLUDING, AMONG OTHERS, DAMAGES FOR LOSS OF BUSINESS PROFITS, BUSINESS INTERRUPTION, OR LOSS OF DATA OR DOCUMENTATION, IN CONNECTION WITH THE USE OF THIS PRODUCT, EVEN IF HIKVISION HAS BEEN ADVISED OF THE POSSIBILITY OF SUCH DAMAGES.

REGARDING TO THE PRODUCT WITH INTERNET ACCESS, THE USE OF PRODUCT SHALL BE WHOLLY AT YOUR OWN RISKS. HIKVISION SHALL NOT TAKE ANY RESPONSIBILITIES FOR ABNORMAL OPERATION, PRIVACY LEAKAGE OR OTHER DAMAGES RESULTING FROM CYBER ATTACK, HACKER ATTACK, VIRUS INSPECTION, OR OTHER INTERNET SECURITY RISKS; HOWEVER, HIKVISION WILL PROVIDE TIMELY TECHNICAL SUPPORT IF REQUIRED.

SURVEILLANCE LAWS VARY BY JURISDICTION. PLEASE CHECK ALL RELEVANT LAWS IN YOUR JURISDICTION BEFORE USING THIS PRODUCT IN ORDER TO ENSURE THAT YOUR USE CONFORMS THE

APPLICABLE LAW. HIKVISION SHALL NOT BE LIABLE IN THE EVENT THAT THIS PRODUCT IS USED WITH ILLEGITIMATE PURPOSES.

IN THE EVENT OF ANY CONFLICTS BETWEEN THIS MANUAL AND THE APPLICABLE LAW, THE LATER PREVAILS.

## **Regulatory Information**

### **FCC Information**

**FCC compliance:** This equipment has been tested and found to comply with the limits for a digital device, pursuant to part 15 of the FCC Rules. These limits are designed to provide reasonable protection against harmful interference when the equipment is operated in a commercial environment. This equipment generates, uses, and can radiate radio frequency energy and, if not installed and used in accordance with the instruction manual, may cause harmful interference to radio communications. Operation of this equipment in a residential area is likely to cause harmful interference in which case the user will be required to correct the interference at his own expense.

### **FCC Conditions**

This device complies with part 15 of the FCC Rules. Operation is subject to the following two conditions:

1. This device may not cause harmful interference.
2. This device must accept any interference received, including interference that may cause undesired operation.

### **EU Conformity Statement**



This product and - if applicable - the supplied accessories too are marked with "CE" and comply therefore with the applicable harmonized European

standards listed under the EMC Directive 2014/30/EU, the RoHS Directive 2011/65/EU.



2012/19/EU (WEEE directive): Products marked with this symbol cannot be disposed of as unsorted municipal waste in the European Union. For proper recycling, return this product to your local supplier upon the purchase of equivalent new equipment, or dispose of it at designated collection points. For more information see: [www.recyclethis.info](http://www.recyclethis.info)



2006/66/EC (battery directive): This product contains a battery that cannot be disposed of as unsorted municipal waste in the European Union. See the product documentation for specific battery information. The battery is marked with this symbol, which may include lettering to indicate cadmium (Cd), lead (Pb), or mercury (Hg). For proper recycling, return the battery to your supplier or to a designated collection point. For more information see: [www.recyclethis.info](http://www.recyclethis.info)

### **Industry Canada ICES-003 Compliance**

This device meets the CAN ICES-3 (A)/NMB-3(A) standards requirements.



### **Safety Instruction**

These instructions are intended to ensure that user can use the product correctly to avoid danger or property loss.

The precaution measure is divided into “Warnings” and “Cautions”

**Warnings:** Serious injury or death may occur if any of the warnings are neglected.

**Cautions:** Injury or equipment damage may occur if any of the cautions are neglected.

	
<b>Warnings</b> Follow these safeguards to prevent serious injury or death.	<b>Cautions</b> Follow these precautions to prevent potential injury or material damage.



### Warnings

- Proper configuration of all passwords and other security settings is the responsibility of the installer and/or end-user.
- In the use of the product, you must be in strict compliance with the electrical safety regulations of the nation and region. Please refer to technical specifications for detailed information.
- Input voltage should meet both the SELV (Safety Extra Low Voltage) and the Limited Power Source with 24 VAC or 12 VDC according to the IEC60950-1 standard. Please refer to technical specifications for detailed information.
- Do not connect several devices to one power adapter as adapter overload may cause over-heating or a fire hazard.
- Please make sure that the plug is firmly connected to the power socket. When the product is mounted on wall or ceiling, the device shall be firmly fixed.

- If smoke, odor or noise rise from the device, turn off the power at once and unplug the power cable, and then please contact the service center.



### **Cautions**

- Make sure the power supply voltage is correct before using the camera.
- Do not drop the camera or subject it to physical shock.
- Do not touch sensor modules with fingers. If cleaning is necessary, use clean cloth with a bit of ethanol and wipe it gently. If the camera will not be used for an extended period, please replace the lens cap to protect the sensor from dirt.
- Do not aim the camera at the sun or extra bright places. Blooming or smearing may occur otherwise (which is not a malfunction), and affect the endurance of sensor at the same time.
- The sensor may be burned out by a laser beam, so when any laser equipment is in using, make sure that the surface of sensor will not be exposed to the laser beam.
- Do not place the camera in extremely hot, cold (the operating temperature shall be between  $-40^{\circ}\text{C} \sim 65^{\circ}\text{C}$ ), dusty or damp locations, and do not expose it to high electromagnetic radiation.
- To avoid heat accumulation, good ventilation is required for operating environment.
- Keep the camera away from liquid while in use.

- While in delivery, the camera shall be packed in its original packing, or packing of the same texture.
- Regular part replacement: a few parts (e.g. electrolytic capacitor) of the equipment shall be replaced regularly according to their average enduring time. The average time varies because of differences between operating environment and using history, so regular checking is recommended for all the users. Please contact with your dealer for more details.
- Improper use or replacement of the battery may result in hazard of explosion. Replace with the same or equivalent type only. Dispose of used batteries according to the instructions provided by the battery manufacturer.
- If the product does not work properly, please contact your dealer or the nearest service center. Never attempt to disassemble the camera yourself. (We shall not assume any responsibility for problems caused by unauthorized repair or maintenance.)

0505161090329



# Table of Contents

<b>1 Appearance Description .....</b>	<b>10</b>
1.1 Type I Camera Overview.....	10
1.2 Type II Camera Overview.....	12
1.3 Type III Camera Overview.....	13
<b>2 Installation.....</b>	<b>15</b>
2.1 microSD Card Installation .....	16
2.1.1 Type I Camera Card Installation .....	16
2.1.2 Type II Camera Card Installation .....	18
2.1.3 Type III Camera Card Installation .....	19
2.2 Wide Range Coverage .....	20
2.3 Wall Mounting .....	22
2.3.1 Type I Camera Installation .....	22
2.3.2 Type II Camera Installation .....	24
2.3.3 Type III Camera Installation .....	27
2.4 Installation of Network Cable Water-proof Jacket (Optional).....	32
<b>3 Setting the Network Camera over the LAN .....</b>	<b>35</b>
3.2 Wiring .....	35
3.3 Activating the Camera.....	36
3.3.1 Activation via Web Browser.....	36
3.3.2 Activation via SADP Software .....	37
3.4 Modifying the IP Address .....	39
<b>4 Accessing via Web Browser .....</b>	<b>42</b>
<b>Appendix .....</b>	<b>45</b>
Common Material Emissivity Reference.....	45

# 1 Appearance Description

---

There are three thermal & optical Bi-spectrum network bullet cameras. Here are the overviews of Type I camera, Type II camera, and Type III camera.

## 1.1 Type I Camera Overview

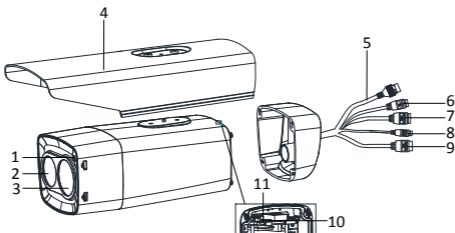

Figure 1-1 Type I Camera Overview (1)

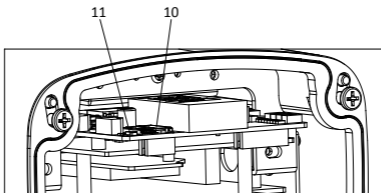

Figure 1-2 Type I Camera Overview (2)

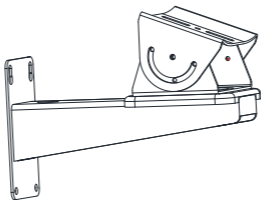

Figure 1-3 Wall Mounting Bracket (Optional)

Table 1-1 Description

No.	Description	No.	Description
1	Photoresister	2	Lens (Optical)
3	Lens (Thermal)	4	Sun Shield
5	Network Cable	6	Power Supply Interface
7	Alarm Interface	8	RS-485
9	Audio Interface	10	microSD Card
11	Reset		

## 1.2 Type II Camera Overview

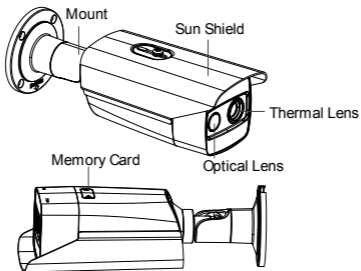

Figure 1-4 Type II Camera Overview

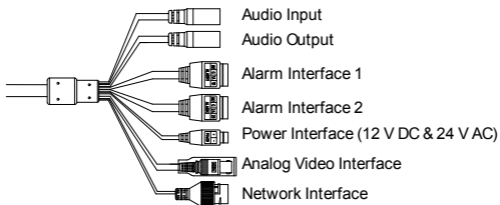

Figure 1-5 Type II Camera Cables

**Note:** PoE+ (power over ethernet) is supported for type II camera. Use appropriate switch.

### 1.3 Type III Camera Overview

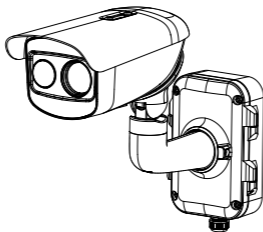

Figure 1-6 Type III Camera Overview

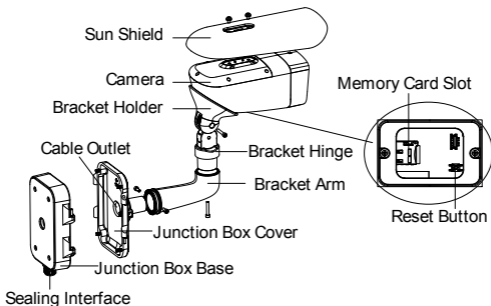

Figure 1-7 Type III Camera Cables

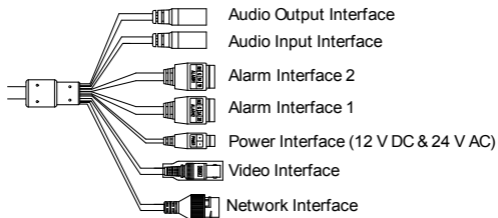

Figure 1-8 Type III Camera Cables

**Note:** PoE+ is supported for type II camera. Use appropriate switch.

**Note:**

To reset the camera to default parameters, you need to press and hold the RESET button and power on the camera. After the power on of the camera, you must still press and hold the Reset button for about 20 seconds.

## 2 Installation

---

### *Before you start:*

- Make sure the device in the package is in good condition and all the assembly parts are included.
- The standard power supply is 12V DC, 24V AC, or PoE+, please make sure your power supply matches with your camera.
- Make sure all the related equipment is power-off during the installation.
- Check the specification of the products for the installation environment.
- Make sure that the wall is strong enough to withstand four times the weight of the camera and the bracket.

For the camera that supports IR, you are required to pay attention to the following precautions to prevent IR reflection:

- Dust or grease on the camera cover will cause IR reflection. Please do not remove the camera cover film until the installation is finished. If there is dust or grease on the camera cover, clean the camera cover with clean soft cloth and isopropyl alcohol.
- Make sure that there is no reflective surface too close to the camera lens. The IR light from the camera may reflect back into the lens causing reflection.
- Do NOT drag the camera with its waterproof cables, or the waterproof performance is affected.

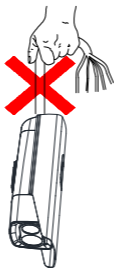

## 2.1 microSD Card Installation

### 2.1.1 Type I Camera Card Installation

#### *Steps:*

1. Unscrew and remove the sun shield.

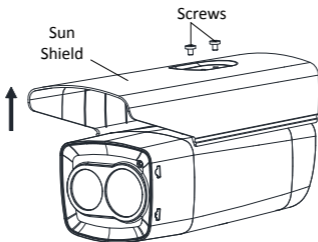

Figure 2-1 Removing Sun Shield



2. Unscrew and remove the back cover.

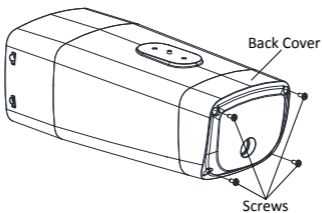

Figure 2-2 Removing Back Cover Case

3. Insert a microSD card into the microSD card slot.

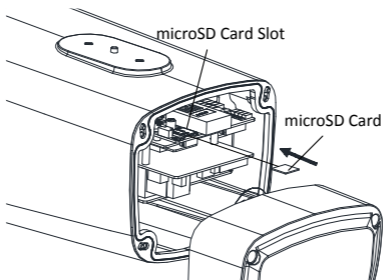

Figure 2-3 Inserting microSD Card

4. Fix the sun shield and back cover to the camera body with the removed screws.

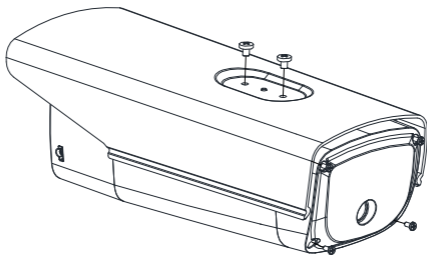

Figure 2-4 Fixing Sun Shield and Back Cover

## 2.1.2 Type II Camera Card Installation

### **Steps:**

1. Unscrew and remove the sun shield.

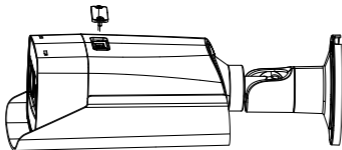

Figure 2-5 Removing Card Slot Cover

2. Insert a microSD card into the microSD card slot until the card clicks.

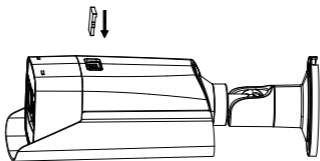

Figure 2-6 Inserting microSD Card

3. Cover the memory card slot and fix the screws on the memory card slot cover.

### 2.1.3 Type III Camera Card Installation

**Steps:**

1. Unscrew the memory card slot cover and remove it.

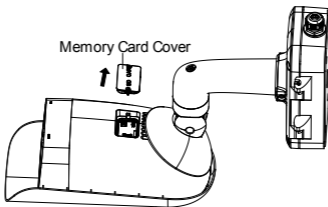

Figure 2-7 Removing Card Slot Cover

2. Insert the memory card into the memory card slot.

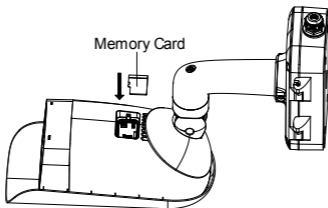

Figure 2-8 Inserting Memory Card

3. Cover the memory card slot and fix the screws on the memory card slot cover.

## 2.2 Wide Range Coverage

Select the proper installation site, and proper lens focal length according to the Wide Range Coverage list below:

Table 2-1 Wide Range Coverage

Lens (focal length)	7mm	10mm	15mm	25mm	35mm	50mm	75mm
Detection range (Vehicles)	631m	902m	1353m	2255m	3157m	4510m	6765m
Detection range (Humans)	206m	294m	441m	735m	1029m	1471m	2206m
Recognition range (Vehicles)	158m	225m	338m	564m	789m	1127m	1691m
Recognition range (Humans)	51m	74m	110m	184m	257m	368m	551m
Identification range (Vehicles)	79m	113m	169m	282m	395m	564m	846m
Identification range (Humans)	26m	37m	55m	92m	129m	184m	276m

Take human as 0.5 m (width) × 1.8 m (height), and limit length is 0.75 m. The vehicle limit length is 2.3 m.

- Detect target: The target should be at least 1.5 pixels on the image.
- Recognize target: The target should be at least 6 pixels on the image.
- Identify target: The target should be at least 12 pixels on the image.

**Note:**

This table is for reference only, and the actual detection range may vary according to different camera settings, mounting condition, monitor and so on.

## 2.3 Wall Mounting

### 2.3.1 Type I Camera Installation

**Steps:**

1. Fix the bullet camera with the mounting bracket with expansion screws or bolts, as shown in Figure 2-9.

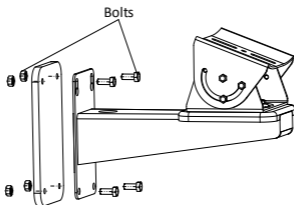

Figure 2-9 Install the Bracket onto the Wall

2. Fix the bullet camera to the mounting bracket with the supplied screws, as shown in Figure 2-10.

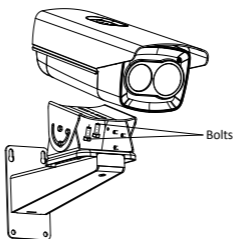

Figure 2-10 Fix the Camera to the Bracket

3. Bolt the camera body to the bracket.

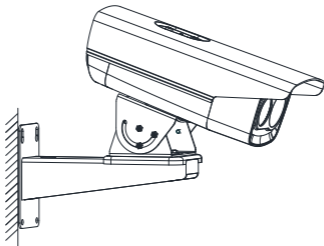

Figure 2-11 Fix the Camera to the Wall

4. Adjust the camera to the optimal surveillance angle.

- 1) Loosen the pan adjusting screw to adjust panning position [0°~360°]. Tighten the screw.

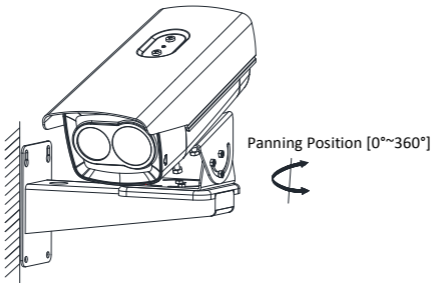

Figure 2-12 Pan Adjustment

- 2) Loosen the tilt adjusting screw to adjust the tilting position [-45° to 45°]. Tighten the screw.

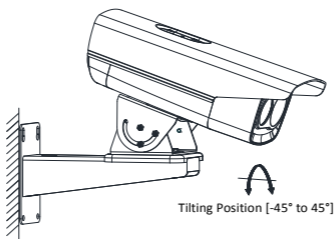

Figure 2-13 Tilt Adjustment

**Note:**

Please loosen the screws slightly until you can adjust the camera.  
Do not remove the screws from the bracket.

### 2.3.2 Type II Camera Installation

**Steps:**

1. Select the proper place, and attach the drill template onto the wall/ceiling, as shown in Figure 2-9.



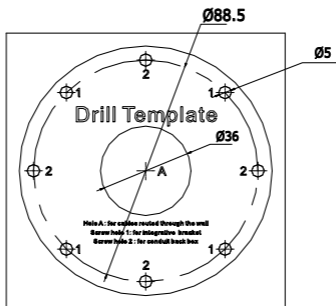

Figure 2-14 Drill Template

2. (Optional) For cement walls, drill four  $\Phi 5$  installation holes according to the template (recommended depth: 25 mm) and insert the expansion screws. Otherwise, skip the step.
3. Drill a cable hole in the center.
4. Install the bullet camera with the screws (supplied).

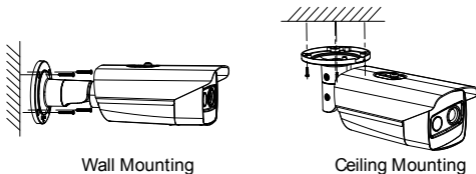

Figure 2-15 Wall/Ceiling Mounting

5. Adjust the camera to the optimal surveillance angle.

Bracket type I:

- 1) Loosen the tilt adjusting screw to adjust tilting position [0°~360°]. Tighten the screw.
- 2) Loosen the pan adjusting screw to adjust the panning position [-45° to 45°]. Tighten the screw.
- 3) Loosen the rotation adjusting screw to rotate the camera [0° to 360°]. Tighten the screw.

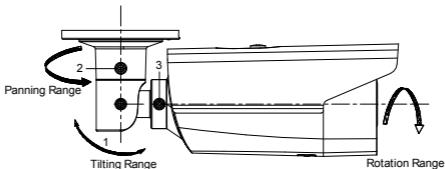

Figure 2-16 3-Axis Adjustment

Bracket type II:

- 1) Loosen the screw to adjust the tilting position [0° to 90°]. Tighten the screw.
- 2) Loosen the screw to adjust the rotation position [0° to 360°]. Tighten the screw.

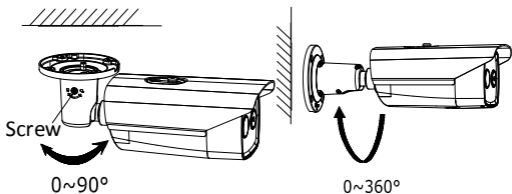

Figure 2-17 2-axis Adjustment

### 2.3.3 Type III Camera Installation

**Before you start:**

There are three methods of Type III camera installation: wall mounting, ceiling mounting, and stand mounting.

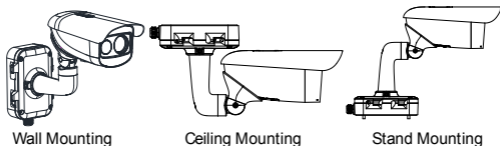

Figure 2-18 Type III Camera Installation Methods

**Steps:**

1. Loosen the screws on the junction box cover.
2. Draw the latches from the latch hole of the junction box and take apart the cover from the junction box.

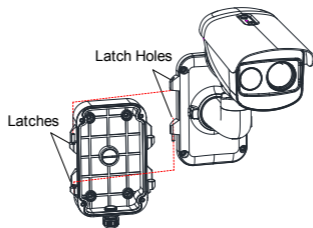

Figure 2-19 Take Apart Junction Box

3. Attach the drill template (supplied) to the place where you want to fix the camera, and then drill four screw holes (recommended depth: 40mm) in the ceiling/wall according to the drill template.
4. Drill a cable hole according to the *A* mark of the drill template.

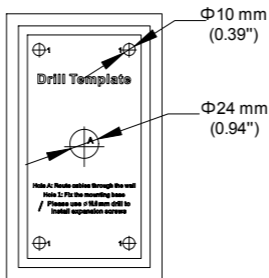

Figure 2-20 Drill Template

5. Align the hole of drill template with the screw hole of the junction box base to place the junction box onto the wall.
6. Route the screw through the sealing ring, and fix the junction box base on the wall with the screws.

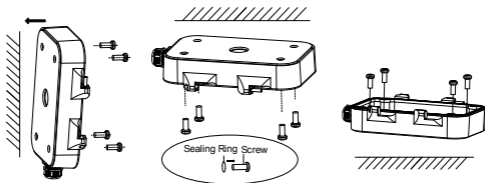

Figure 2-21 Installing Junction Box Base

7. Route the cables through the cable hole.
8. Insert the latches into the latch holes to fix the bracket and camera with the junction box.

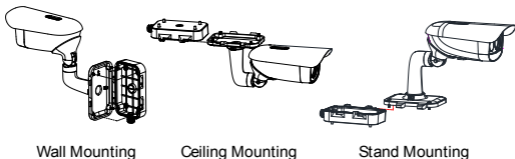

Figure 2-22 Installing Junction Box Cover

9. Fix the delivered screws to secure the junction box.

10. Connect the corresponding cables to power on the camera and get the live view.

11. Adjust the camera according to the figure below.

- 1) Loosen the rotation adjusting screw to rotate the camera [-180° to +180°]. Tighten the screw.

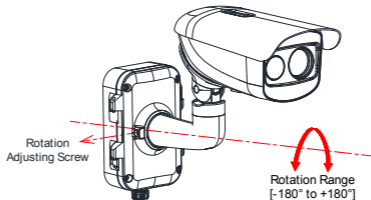

Figure 2-23 R-Axis Adjustment

- 2) Loosen the tilt adjusting screw to adjust tilting position [-90° to +55°]. Tighten the screw.

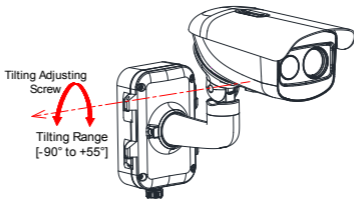

Figure 2-24 T-Axis Adjustment

- 3) Loosen the pan adjusting screw to adjust the panning position [-90° to 90°]. Tighten the screw.

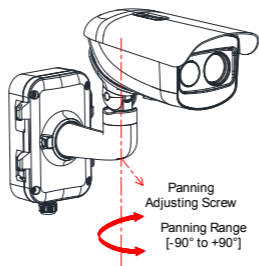

Figure 2-25 P-Axis Adjustment

## 2.4 Installation of Network Cable Water-proof Jacket (Optional)

### *Purpose:*

If the camera is installed outdoor, you can adapt the water-proof accessory for the network cable after the camera is secured on the installation surface.

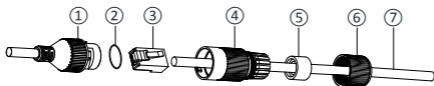

Figure 2-1 Water-proof Accessory Components

Table 2-1 Components

No.	Components
1	Camera's Network Interface Socket
2	O-Type Gasket
3	Network Plug
4	Waterproof Endcap
5	Waterproof Rubber Gasket
6	Lock Nut
7	Network Cable from Router/Switch



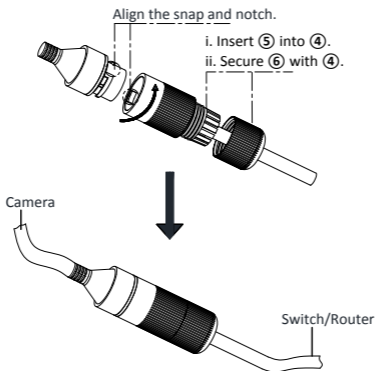

Figure 2-26 Water-proof Accessory Installation

**Steps:**

1. Feed the plugless network cable ⑦ through the lock nut ⑥, waterproof rubber gasket ⑤ (rubber gasket inset ridge must face waterproof endcap), and the water-proof endcap ④ in order.
2. Crimp an RJ-45 network plug ③ onto the end of the cable, taking care to insert the twisted pairs of wires in correct order.
3. Place the O-type gasket ② onto the end of the camera's network interface socket ①.
4. Insert the network plug ③ into the camera's network interface socket ①.

5. Insert the water-proof rubber gasket ⑤ into the waterproof endcap ④, and secure lock nut ⑥ with the water-proof endcap ④.
6. Align the snap on the water-proof endcap ④ with the notch on the camera's network interface socket ①, and then secure the water-proof endcap ④ to the camera's network interface socket ① to finish installation.

## 3 Setting the Network Camera over the LAN

---

### **Note:**

You shall acknowledge that the use of the product with Internet access might be under network security risks. For avoidance of any network attacks and information leakage, please strengthen your own protection. If the product does not work properly, please contact with your dealer or the nearest service center.

### 3.1 Wiring

Please connect to the camera to the network according to the following figures



Figure 2-27 Connecting Directly

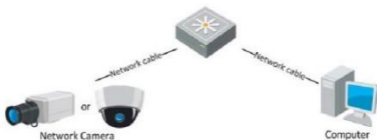

Figure 2-28 Connecting via a Switch or a Router

## 3.2 Activating the Camera

You are required to activate the camera first by setting a strong password for it before you can use the camera.

Activation via Web Browser, Activation via SADP, and Activation via Client Software are all supported. We will take activation via SADP software and Activation via Web Browser as examples to introduce the camera activation. Please refer to the User Manual of Network Camera for Activation via Client Software.

### 3.2.1 Activation via Web Browser

#### **Steps:**

1. Power on the camera, and connect the camera to the network.
2. Input the IP address into the address bar of the web browser, and click Enter to enter the activation interface.

#### **Notes:**

- The default IP address of the camera is 192.168.1.64.
- For the camera enables the DHCP by default, you need to activate the camera via SADP software and search the IP address.



Figure 2-29 Activation Interface(Web)

3. Create a password and input the password into the password field.



**STRONG PASSWORD RECOMMENDED**– *We highly recommend you create a strong password of your own choosing (using a minimum of 8 characters, including upper case letters, lower case letters, numbers, and special characters) in order to increase the security of your product. And we recommend you reset your password regularly, especially in the high security system, resetting the password monthly or weekly can better protect your product.*

4. Confirm the password.
5. Click **OK** to save the password and enter the live view interface.

### 3.2.2 Activation via SADP Software

SADP software is used for detecting the online device, activating the camera, and resetting the password.

Get the SADP software from the supplied disk or the official website, and install the SADP according to the prompts. Follow the steps to activate the camera, please refer to the User Manual of Network Camera for other two activation methods.

#### **Steps:**

1. Run the SADP software to search the online devices.
2. Check the device status from the device list, and select the inactive device.

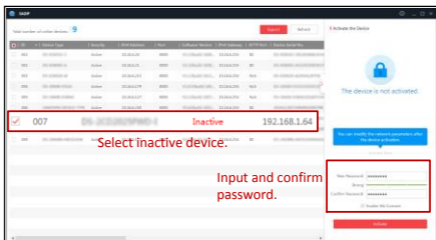

Figure 2-30 SADP Interface

**Note:**

The SADP software supports activating the camera in batch. Please refer to the user manual of SADP software for details.

3. Create a password and input the password in the password field, and confirm the password.



**STRONG PASSWORD RECOMMENDED**– *We highly recommend you create a strong password of your own choosing (using a minimum of 8 characters, including upper case letters, lower case letters, numbers, and special characters) in order to increase the security of your product. And we recommend you reset your password regularly, especially in the high security system, resetting the password monthly or weekly can better protect your product.*

4. Click **OK** to save the password.

You can check whether the activation is completed on the popup window. If activation failed, please make sure that the password meets the requirement and try again.

### 3.3 Modifying the IP Address

***Purpose:***

To view and configure the camera via LAN (Local Area Network), you need to connect the network camera in the same subnet with your PC. Then, install the SADP software or client software to search and change the IP of network camera. We will take modifying the IP Address via SADP software as an example to introduce the IP address modification.

***Steps:***

1. Run the SADP software.
2. Select an active device.

**Note:**

Please refer to Chapter 3.2 to activate the camera if the camera is inactive.

3. Change the device IP address to the same subnet with your computer by either modifying the IP address manually or checking the checkbox of Enable DHCP.

### Modify Network Parameters

Enable DHCP  
 Enable Hik-Connect

Device Serial No.:

IP Address:

Port:

Subnet Mask:

Gateway:

IPv6 Address:

IPv6 Gateway:

IPv6 Prefix Length:

HTTP Port:

---

Security Verification

Admin Password:

[Modify](#)

[Forgot Password](#)

Figure 2-31 Modify the IP Address



4. Input the password to activate your IP address modification.

The batch IP address modification is supported by the SADP; please refer to the User Manual of SADP for details.

## 4 Accessing via Web Browser

---

### **System Requirement:**

Operating System: Microsoft Windows XP SP1 and above version

CPU: 2.0 GHz or higher

RAM: 1G or higher

Display: 1024×768 resolution or higher

Web Browser: Internet Explorer 8.0 and above version, Apple Safari 5.0.2 and above version, Mozilla Firefox 5.0 and above version and Google Chrome 18 and above version

### **Steps:**

1. Open the web browser.
2. In the browser address bar, input the IP address of the network camera, and press the **Enter** key to enter the login interface.

#### **Note:**

- The default IP address is 192.168.1.64.
  - If the camera is not activated, please activate the camera first according to Chapter 3.2.
3. Input the user name and password.

The admin user should configure the device accounts and user/operator permissions properly. Delete the unnecessary accounts and user/operator permissions.

#### **Note:**

The device IP address gets locked if the admin user performs 7 failed password attempts (5 attempts for the user/operator).

4. Click **Login**.



Figure 2-32 Login Interface

5. Install the plug-in before viewing the live video and managing the camera. Please follow the installation prompts to install the plug-in.

**Note:**

You may have to close the web browser to finish the installation of the plug-in.

[Please click here to download and install the plug-in. Close the browser when installing the plug-in.](#)

Figure 2-33 Download Plug-in

6. Reopen the web browser after the installation of the plug-in and repeat steps 2~4 to login.

**Note:**

For detailed instructions of further configuration, please refer to the user manual of network camera.

## Appendix

---

### Common Material Emissivity Reference

Material	Emissivity
Human Skin	0.98
PCB	0.91
Cement Concrete	0.95
Ceramics	0.92
Rubber	0.95
Paint	0.93
Wood	0.85
Asphalt	0.96
Brick	0.95
Sand	0.90
Soil	0.92
Cotton	0.98
Cardboard	0.90
White Paper	0.90
Water	0.96

