

DS-2CD2T87G2-LSU/SL

8 MP ColorVu Strobe Light and Audible Warning Fixed Bullet Network Camera

ColorVu



Hikvision ColorVu technology provides 24/7 vivid colorful images with F1.0 advanced lenses and high performance sensors. F1.0 super-aperture collects more light to produce brighter images. Advanced sensor technology can vastly improve the utilization of available light.

- High quality imaging with 8 MP resolution
- Efficient H.265+ compression technology
- Clear imaging against strong backlight due to 130 dB WDR technology
- Focus on human and vehicle targets classification based on deep learning
- 24/7 colorful imaging
- Active strobe light and audio alarm to warn intruders off
- Provide real-time security via built-in two-way audio
- Audio and alarm interface available
- Water and dust resistant (IP67)



▪ Specification

Camera	
Image Sensor	1/1.2" Progressive Scan CMOS
Max. Resolution	3840 × 2160
Min. Illumination	Color: 0.0005 Lux @ (F1.0, AGC ON), 0 Lux with white light
Shutter Time	1/3 s to 1/100,000 s
Angle Adjustment	Pan: 0° to 360°, tilt: 0° to 90°, rotate: 0° to 360°
Day & Night	24/7 color imaging
Lens	
Lens Type	Fixed focal lens, 2.8, 4, 6 mm optional
Focal Length & FOV	2.8 mm, horizontal FOV 102°, vertical FOV 52°, diagonal FOV 124° 4 mm, horizontal FOV 88°, vertical FOV 47°, diagonal FOV 104° 6 mm: horizontal FOV 54°, vertical FOV 30°, diagonal FOV 62°
Iris Type	Fixed
Lens Mount	M mount
Aperture	F1.0
Depth of Field	2.8 mm: 4.5 m to ∞ 4 mm: 7 m to ∞ 6 mm: 13 m to ∞
DORI	
DORI	2.8 mm: D: 96 m, O: 38 m, R: 19 m, I: 9 m 4 mm: D: 102 m, O: 40 m, R: 20 m, I: 10 m 6 mm, D: 167 m, O: 66 m, R: 33 m, I: 16 m
Illuminator	
Supplement Light Type	White Light
Supplement Light Range	60 m
Smart Supplement Light	Yes
Video	
Main Stream	50 Hz: 25 fps (3840 × 2160, 3200 × 1800, 2688 × 1520, 1920 × 1080, 1280 × 720) 60 Hz: 24 fps (3840 × 2160) 30 fps (3200 × 1800, 2688 × 1520, 1920 × 1080, 1280 × 720)
Sub-Stream	50 Hz: 25 fps (640 × 480, 640 × 360) 60 Hz: 30 fps (640 × 480, 640 × 360)
Third Stream	50 Hz: 10 fps (1920 × 1080, 1280 × 720, 640 × 480, 640 × 360) 60 Hz: 10 fps (1920 × 1080, 1280 × 720, 640 × 480, 640 × 360)
Video Compression	Main stream: H.265/H.264/H.264+/H.265+ Sub-stream: H.265/H.264/MJPEG Third stream: H.265/H.264
Video Bit Rate	32 Kbps to 16 Mbps
H.264 Type	Baseline Profile/Main Profile/High Profile
H.265 Type	Main Profile
Bit Rate Control	CBR/VBR
Scalable Video Coding (SVC)	Yes

Region of Interest (ROI)	1 fixed region for main stream and sub-stream
Network	
Protocols	TCP/IP, ICMP, HTTP, HTTPS, FTP, DHCP, DNS, DDNS, RTP, RTSP, NTP, UPnP, SMTP, IGMP, 802.1X, QoS, IPv4, IPv6, UDP, Bonjour, SSL/TLS, PPPoE, SNMP
Simultaneous Live View	Up to 6 channels
API	Open Network Video Interface (Profile S, Profile G, Profile T), ISAPI, SDK
User/Host	Up to 32 users. 3 user levels: administrator, operator and user
Security	Password protection, complicated password, HTTPS encryption, IP address filter, Security Audit Log, basic and digest authentication for HTTP/HTTPS, TLS 1.1/1.2, WSSE and digest authentication for Open Network Video Interface
Network Storage	NAS (NFS, SMB/CIFS), auto network replenishment (ANR)
Client	iVMS-4200, Hik-Connect, Hik-Central
Web Browser	Plug-in required live view: IE 10, IE 11 Plug-in free live view : Chrome 57.0+, Firefox 52.0+ Local service: Chrome 57.0+, Firefox 52.0+
Image	
Image Parameters Switch	Yes
Image Settings	Rotate, mirror, privacy mask, saturation, brightness, contrast, sharpness, gain, white balance adjustable by client software or web browser
Day/Night Switch	Day, Night, Auto, Schedule
Wide Dynamic Range (WDR)	130 dB
SNR	≥ 52 dB
Image Enhancement	BLC, HLC, 3D DNR
Privacy Mask	4 programmable polygon privacy masks, mask color or mosaic configurable
Interface	
Ethernet Interface	1 RJ45 10 M/100 M self-adaptive Ethernet port
On-Board Storage	Built-in memory card slot, support microSD/microSDHC/microSDXC/TF card, up to 256 GB
Reset Key	Yes
Built-in Microphone	Yes
Built-in Speaker	2 W, 10 cm: 97 dB
Audio	1 input (line in), max. input amplitude: 3.3 Vpp, input impedance:4.7 KΩ, interface type: non-equilibrium 1 output (line out), max.output amplitude: 3.3 Vpp, output impedance: 100 Ω, interface type: non-equilibrium
Alarm	1 input, 1 output (max. 24 VDC, 1 A)
Event	
Basic Event	Motion detection (support alarm triggering by specified target types (human and vehicle)), video tampering alarm, exception (network disconnected, IP address conflict, illegal login, HDD full, HDD error)
Smart Event	Line crossing detection, intrusion detection, region entrance detection, region exiting detection (support alarm triggering by specified target types (human and vehicle)), scene change detection
Linkage	Upload to NAS/memory card/FTP, notify surveillance center, trigger record, trigger capture, send email

Deep Learning Function	
Face Capture	Yes
General	
Power	12 VDC \pm 25%, 0.84 A, max. 11.5 W, \varnothing 5.5 mm coaxial power plug, reverse polarity protection PoE: 802.3af, Class 3, 36 V to 57 V, 0.32 A to 0.21 A
Material	Front cover: metal, body: metal, bracket: metal
Dimension	289.9 mm \times 93.5 mm \times 91.2 mm (11.4" \times 3.7" \times 3.6")
Package Dimension	386 \times 156 \times 155 mm (15.2" \times 6.1" \times 6.1")
Weight	Approx. 1255 g (2.6 lb.)
With Package Weight	Approx. 1769 g (3.7 lb.)
Storage Conditions	-30 $^{\circ}$ C to 60 $^{\circ}$ C (-22 $^{\circ}$ F to 140 $^{\circ}$ F). Humidity 95% or less (non-condensing)
Startup and Operating Conditions	-30 $^{\circ}$ C to 60 $^{\circ}$ C (-22 $^{\circ}$ F to 140 $^{\circ}$ F). Humidity 95% or less (non-condensing)
Language	33 languages English, Russian, Estonian, Bulgarian, Hungarian, Greek, German, Italian, Czech, Slovak, French, Polish, Dutch, Portuguese, Spanish, Romanian, Danish, Swedish, Norwegian, Finnish, Croatian, Slovenian, Serbian, Turkish, Korean, Traditional Chinese, Thai, Vietnamese, Japanese, Latvian, Lithuanian, Portuguese (Brazil), Ukrainian
General Function	Anti-flicker, heartbeat, password reset via e-mail, pixel counter
Approval	
EMC	FCC (47 CFR Part 15, Subpart B); CE-EMC (EN 55032: 2015, EN 61000-3-2:2019, EN 61000-3-3:2013+A1:2019, EN 50130-4: 2011 +A1: 2014); RCM (AS/NZS CISPR 32: 2015); IC (ICES-003: Issue 7) KC (KN32: 2015, KN35: 2015)
Safety	UL (UL 62368-1); CB (IEC 62368-1:2014+A11) CE-LVD (EN 62368-1:2014/A11:2017)
Environment	CE-RoHS (2011/65/EU); WEEE (2012/19/EU); Reach (Regulation (EC) No 1907/2006)
Protection	IP67 (IEC 60529-2013)

▪ Available Model

DS-2CD2T87G2-LSU/SL (2.8/4/6 mm)

▪ Typical Application

Hikvision products are classified into three levels according to their anti-corrosion performance. Refer to the following description to choose for your using environment.

This model has NO SPECIFIC PROTECTION.

Level	Description
Top-level protection	Hikvision products at this level are equipped for use in areas where professional anti-corrosion protection is a must. Typical application scenarios include coastlines, docks, chemical plants, and more.
Moderate protection	Hikvision products at this level are equipped for use in areas with moderate anti-corrosion demands. Typical application scenarios include coastal areas about 2 kilometers (1.24 miles) away from coastlines, as well as areas affected by acid rain.
No specific protection	Hikvision products at this level are equipped for use in areas where no specific anti-corrosion protection is needed.

▪ **Dimension**

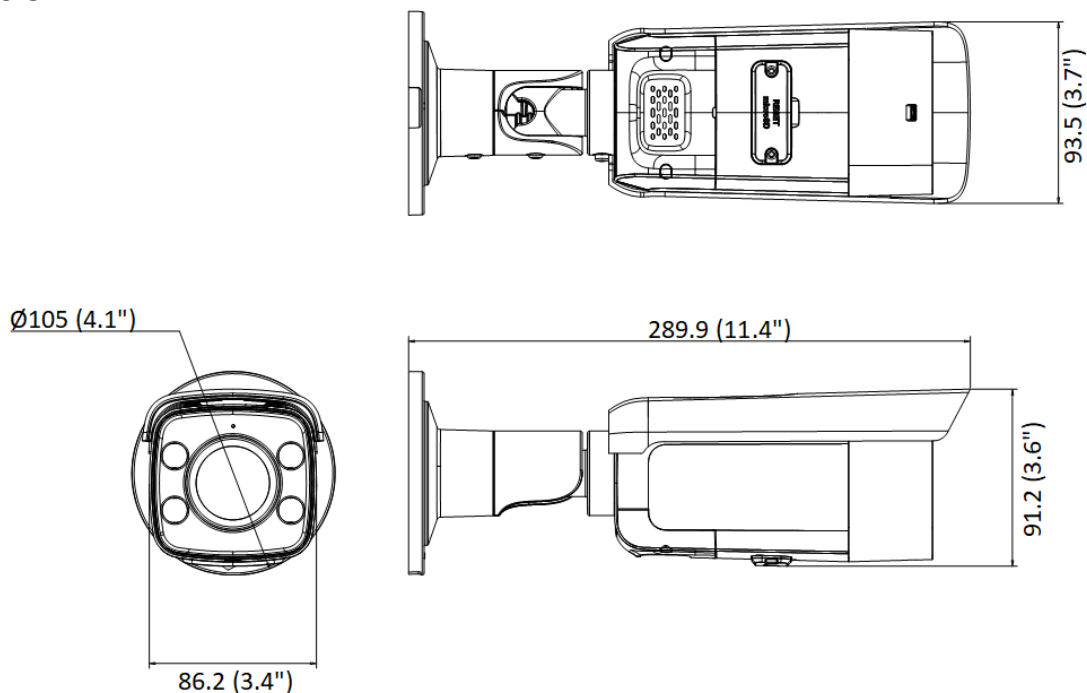

Unit:mm (inch)

▪ Accessory**▪ Optional**

DS-1276ZJ-SUS Corner Mount	DS-1275ZJ-SUS Vertical Pole Mount	DS-1275ZJ-S-SUS Vertical Pole Mount	DS-1280ZJ-S Junction Box	DS-1260ZJ Junction Box
				

Distributed by

**HIKVISION®****Headquarters**

No.555 Qianmo Road, Binjiang District,
Hangzhou 310051, China
T +86-571-8807-5998
overseasbusiness@hikvision.com

Hikvision USA
T +1-909-895-0400
sales.usa@hikvision.com

Hikvision Australia
T +61-2-8599-4233
salesau@hikvision.com

Hikvision India
T +91-22-28469900
sales@pramahikvision.com

Hikvision Canada
T +1-866-200-6690
sales.canada@hikvision.com

Hikvision Thailand
T +662-275-9949
sales.thailand@hikvision.com

Hikvision Europe
T +31-23-5542770
sales.eu@hikvision.com

Hikvision Italy
T +39-0438-6902
info.it@hikvision.com

Hikvision Brazil
T +55 11 3318-0050
Latam.support@hikvision.com

Hikvision Turkey
T +90 (216)521 7070- 7074
sales.tr@hikvision.com

Hikvision Malaysia
T +601-7652-2413
sales.my@hikvision.com

Hikvision UK & Ireland
T +01628-902140
sales.uk@hikvision.com

Hikvision South Africa
Tel: +27 (10) 0351172
sale.africa@hikvision.com

Hikvision France
T +33(0)1-85-330-450
info.fr@hikvision.com

Hikvision Kazakhstan
T +7-727-9730667
nikia.panfilov@hikvision.ru

Hikvision Vietnam
T +84-974270888
sales.vt@hikvision.com

Hikvision UAE
T +971-4-4432090
salesme@hikvision.com

Hikvision Singapore
T +65-6684-4718
sg@hikvision.com

Hikvision Spain
T +34-91-737-16-55
info.es@hikvision.com

Hikvision Tashkent
T +99-87-1238-9438
uzb@hikvision.ru

Hikvision Hong Kong
T +852-2151-1761
info.hk@hikvision.com

Hikvision Russia
T +7-495-669-67-99
saleru@hikvision.com

Hikvision Korea
T +82-(0)31-731-8817
sales.korea@hikvision.com

Hikvision Poland
T +48-22-460-01-50
info.pl@hikvision.com

Hikvision Indonesia
T +62-21-2933759
Sales.Indonesia@hikvision.com

Hikvision Colombia
sales.colombia@hikvision.com