

DS-2CD2655FWD-IZS 5 MP WDR Vari-focal Network Bullet Camera



Key Features

- 1/2.9" Progressive Scan CMOS
- 2944 × 1656 resolution
- H.265, H.265+
- 120dB WDR
- IP67, IK10
- BLC/3D DNR/ROI
- Smart encoding: Support low bit rate, low latency
- 4 behavior analyses and face detection



Specifications

Camera	
Image Sensor	1/2.9" Progressive Scan CMOS
Min. Illumination	Color: 0.01 Lux @ (F1.2, AGC ON), 0 Lux with IR Color: 0.014 Lux @ (F1.4, AGC ON), 0 Lux with IR
Shutter Speed	1/3 s to 1/100,000 s
Slow Shutter	Support
Day & Night	IR Cut Filter
Digital Noise Reduction	3D DNR
WDR	120dB
3-Axis Adjustment	Pan: 0° to 360°, tilt: 0° to 90°, rotate: 0° to 360°
Lens	
Focal length	2.8 to 12 mm
Aperture	F1.4
FOV	Horizontal field of view: 88° to 29° Vertical field of view: 47.5° to 16.5° Diagonal field of view: 103° to 33°
Lens Mount	Ø14
IR	
IR Range	Up to 50 m
Wavelength	850nm
Compression Standard	
Video Compression	Main stream: H.265+/H.265/H.264+/H.264 Sub stream: H.265+/H.265/H.264+/H.264/MJPEG Third stream: H.265+/H.265/H.264+/H.264
H.264 Type	Main Profile/High Profile
H.265 Type	Main Profile
Video Bit Rate	32 Kbps to 16 Mbps
Audio Compression	G722.1/G711ulaw/G711alaw/G726/MP2L2
Audio Bit Rate	32 to 128kbps
Smart Feature-set	
Behavior Analysis	Line crossing detection, intrusion detection, unattended baggage detection, object removal detection
Face Detection	Support
Region of Interest	Support 1 fixed region for each stream
Image	
Max. Resolution	2944 × 1656
Main Stream	50Hz: 20 fps (2944 × 1656), 25 fps (2560 × 1440, 1920 × 1080, 1280 × 720) 60Hz: 20 fps (2944 × 1656), 30 fps (2560 × 1440, 1920 × 1080, 1280 × 720)
Sub Stream	50Hz: 25fps (640 × 360, 352 × 288) 60Hz: 30fps (640 × 360, 352 × 240)
Third Stream	50Hz: 25fps (1280 × 720, 640 × 360, 352 × 288) 60Hz: 30fps (1280 × 720, 640 × 360, 352 × 240)
Image Enhancement	BLC/3D DNR
Image Setting	Rotate mode, saturation, brightness, contrast, sharpness adjustable by client software or web browser

Day/Night Switch	Auto/Schedule/Triggered by Alarm In
Network	
Network Storage	Support Micro SD/SDHC/SDXC card (128G), local storage and NAS (NFS,SMB/CIFS), ANR
Alarm Trigger	Motion detection, video tampering, network disconnected, IP address conflict, illegal login, HDD full, HDD error, Alarm input, Alarm output
Protocols	TCP/IP, ICMP, HTTP, HTTPS, FTP, DHCP, DNS, DDNS, RTP, RTSP, RTCP, PPPoE, NTP, UPnP, SMTP, SNMP, IGMP, 802.1X, QoS, IPv6, Bonjour
General Function	One-key reset, anti-flicker, three streams, heartbeat, password protection, privacy mask, watermark, IP address filter
API	ONVIF (PROFILE S, PROFILE G), CGI, ISAPI
Simultaneous Live View	Up to 6 channels
User/Host	Up to 32 users 3 levels: Administrator, Operator and User
Client	iVMS-4200, iVMS-4500, iVMS-5200
Web Browser	IE8+, Chrome 31.0-44, Firefox 30.0-51, Safari 8.0+
Interface	
Audio	1 input (line in, 3.5 mm), 1 output(3.5 mm), single track
Communication Interface	1 RJ45 10M/100M self-adaptive Ethernet port
Alarm	1 input, 1 output (max. 12 VDC, 30 mA)
Video Output	1Vp-p composite output (75 Ω/BNC)
On-board storage	Built-in Micro SD/SDHC/SDXC slot, up to 128 GB
SVC	H.264 encoding supports
Reset Button	Support
Audio	
Environment Noise Filtering	Support
Audio Sampling Rate	16 kHz
General	
Operating Conditions	-30 °C to +60 °C (-22 °F to +140 °F), Humidity 95% or less (non-condensing)
Power Supply	12 VDC ± 25%, PoE (802.3at) Terminal block for DC input
Power Consumption and Current	12 VDC, 1.3A, max. 15.5W PoE (802.3at, 42.5V to 57V), 0.5A to 0.1A, max. 17.5W
Protection Level	IP67, IK10 TVS 2000V Lightning Protection, Surge Protection and Voltage Transient Protection
Material	Metal
Dimensions	Φ144.13×332.73 mm (Φ5.67"× 13.10")
Weight	Camera: 1893 g (4.17 lb.)

Note: If the WDR and Rotation are both enabled, the frame rate of the main stream should not be more than 20.

Available Model:

DS-2CD2655FWD-IZS

Dimensions

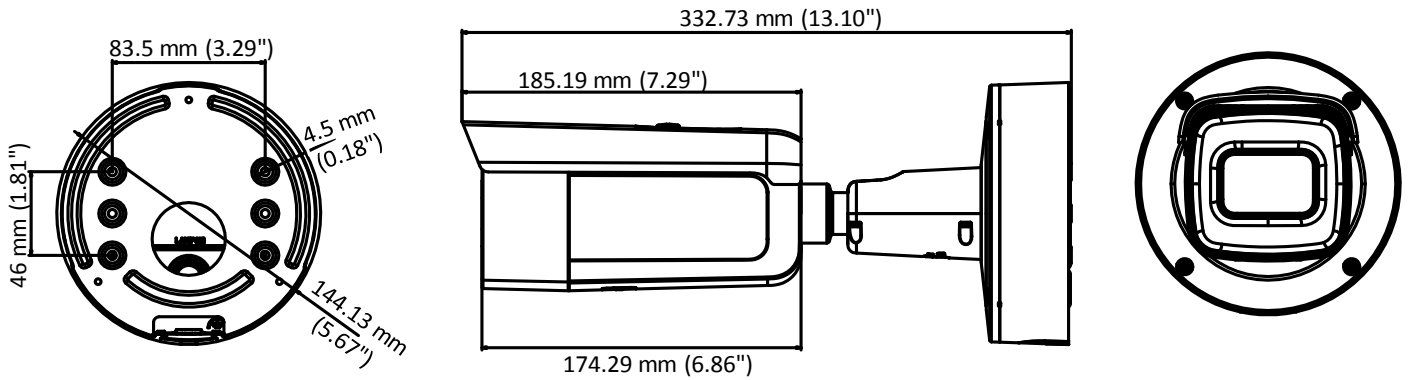

Accessories



DS-1475ZJ-SUS

Vertical Pole Mount

DS-1476ZJ-SUS

Corner Mount

Distributed by



HIKVISION

Headquarters

No.555 Qianmo Road, Binjiang District,
Hangzhou 310051, China
T +86-571-8807-5998
overseasbusiness@hikvision.com

Hikvision USA
T +1-909-895-0400
sales.usa@hikvision.com

Hikvision Italy
T +39-0438-6902
info.it@hikvision.com

Hikvision Singapore
T +65-6684-4718
sg@hikvision.com

Hikvision Africa
T +27 (0) 0351172
sale.africa@hikvision.com

Hikvision Europe
T +31-23-55-42-770
info.eu@hikvision.com

Hikvision France
T +33(0)1-85-330-450
info.fr@hikvision.com

Hikvision Oceania
T +61-2-8599-4233
salesau@hikvision.com

Hikvision Hong Kong
T +852-2151-1761

Hikvision Middle East
T +971-4-8816086
salesme@hikvision.com

Hikvision Spain
T +34-91-737-16-55
info.es@hikvision.com

Hikvision Canada
T +1-909-895-0400
sales.usa@hikvision.com

Hikvision Russia
T +7-495-669-67-99
saleru@hikvision.com

Hikvision Poland
T +48-22-460-01-50
poland@hikvision.com

Hikvision Korea
T +82-31-731-8841
sales.korea@hikvision.com

Hikvision India
T +91-22-28469900
sales@pramahikvision.com

Hikvision UK
T +01628-902140
support.uk@hikvision.com

Hikvision Brazil
T +55 11 3318-0050
Latam.support@hikvision.com