

# Fast Ethernet Smart Switches

---

**AT-FS750/16**  
**AT-FS750/24**

## Installation Guide

Copyright © 2007 Allied Telesis, Inc.

All rights reserved. No part of this publication may be reproduced without prior written permission from Allied Telesis, Inc.

Allied Telesis and the Allied Telesis logo are trademarks of Allied Telesis, Incorporated. All other product names, company names, logos or other designations mentioned herein are trademarks or registered trademarks of their respective owners.

Allied Telesis, Inc. reserves the right to make changes in specifications and other information contained in this document without prior written notice. The information provided herein is subject to change without notice. In no event shall Allied Telesis, Inc. be liable for any incidental, special, indirect, or consequential damages whatsoever, including but not limited to lost profits, arising out of or related to this manual or the information contained herein, even if Allied Telesis, Inc. has been advised of, known, or should have known, the possibility of such damages.

# Electrical Safety and Emissions Standards

---

This product meets the following standards.

## U.S. Federal Communications Commission

### Radiated Energy

Note: This equipment has been tested and found to comply with the limits for a Class A digital device pursuant to Part 15 of FCC Rules. These limits are designed to provide reasonable protection against harmful interference when the equipment is operated in a commercial environment. This equipment generates, uses, and can radiate radio frequency energy and, if not installed and used in accordance with this instruction manual, may cause harmful interference to radio communications. Operation of this equipment in a residential area is likely to cause harmful interference in which case the user will be required to correct the interference at his own expense.

Note: Modifications or changes not expressly approved of by the manufacturer or the FCC, can void your right to operate this equipment.

## Industry Canada

This Class A digital apparatus complies with Canadian ICES-003.

Cet appareil numérique de la classe A est conforme à la norme NMB-003 du Canada.

RFI Emissions      FCC Class A, EN55022 Class A, CISPR Class A, C-TICK, CE

**Warning:** In a domestic environment this product may cause radio interference in which case the user may be required to take adequate measures.

Immunity            EN55024

Electrical Safety    EN60950 (TUV), UL 60950 (C<sub>UL</sub>-US)



Laser Safety        EN60825

## Translated Safety Statements

---

**Important:** The  indicates that a translation of the safety statement is available in a PDF document titled “Translated Safety Statements” (613-000405) posted on the Allied Telesis website at [www.alliedtelesis.com](http://www.alliedtelesis.com).

# Contents

---

|   |    |
|---|----|
| <b>Preface</b> .....                                      | 11 |
| Safety Symbols Used in this Document .....                | 12 |
| Where to Find Web-based Guides .....                      | 13 |
| Contacting Allied Telesis .....                           | 14 |
| Online Support .....                                      | 14 |
| Email and Telephone Support .....                         | 14 |
| Returning Products .....                                  | 14 |
| Sales or Corporate Information .....                      | 14 |
| Warranty .....  | 14 |
| Management Software Updates .....                         | 14 |
| <b>Chapter 1: Overview</b> .....                          | 15 |
| Features .....  | 16 |
| Front and Back Panels .....                               | 17 |
| Ports .....   | 18 |
| Twisted Pair Ports .....                                  | 18 |
| Uplink Combo Ports .....                                  | 18 |
| RS-232 Console Port .....                                 | 18 |
| LEDs .....  | 19 |
| Power Supply .....  | 21 |
| Network Topologies .....                                  | 22 |
| Power Workgroup Topology .....                            | 22 |
| Collapsed Backbone .....                                  | 23 |
| <b>Chapter 2: Installation</b> .....                      | 25 |
| Reviewing Safety Precautions .....                        | 26 |
| Selecting a Site for the Switch .....                     | 28 |
| Cable Specifications .....                                | 29 |
| Unpacking the Switch .....                                | 30 |
| Installing the Switch on a Desktop .....                  | 31 |
| Installing the Switch in an Equipment Rack .....          | 32 |
| Installing an Optional SFP Transceiver .....              | 34 |
| Cabling the Switch .....                                  | 37 |
| Powering On the Switch .....                              | 38 |
| <b>Chapter 3: Troubleshooting</b> .....                   | 39 |
| <b>Appendix A: Technical Specifications</b> .....         | 41 |
| Physical Specifications .....                             | 41 |
| Environmental Specifications .....                        | 41 |
| Power Specifications .....                                | 41 |
| Safety and Electromagnetic Emissions Certifications ..... | 42 |
| Connectors and Port Pinouts .....                         | 42 |



# Figures

---

|   |    |
|---|----|
| Figure 1. AT-FS750/16 and AT-FS750/24 Front Panels .....                  | 17 |
| Figure 2. AT-FS750/16 and AT-FS750/24 Back Panels.....                    | 17 |
| Figure 3. AT-FS750/16 and FS750/24 System and Port LEDs .....             | 19 |
| Figure 4. Power Workgroup Topology .....                                  | 22 |
| Figure 5. Collapsed Backbone Topology.....                                | 23 |
| Figure 6. Attaching the Rubber Feet .....                                 | 31 |
| Figure 7. Attaching the Rack-Mount Bracket to the AT-FS750/16 Switch..... | 32 |
| Figure 8. Attaching the Rack-Mount Bracket to the AT-FS750/24 Switch..... | 32 |
| Figure 9. Mounting the AT-FS750/16 Switch in an Equipment Rack.....       | 33 |
| Figure 10. Mounting the AT-FS750/24 Switch in an Equipment Rack.....      | 33 |
| Figure 11. Removing the Dust Plug from the SFP Slot .....                 | 34 |
| Figure 12. Inserting the SFP.....   | 35 |
| Figure 13. Positioning the SFP Handle in the Upright Position .....       | 35 |
| Figure 14. Plugging in the AC Power Cord.....                             | 38 |
| Figure 15. RJ-45 Connector and Port Pin Layout.....                       | 42 |





# Tables

---

|   |    |
|---|----|
| Table 1. Safety Symbols .....                             | 12 |
| Table 2. System LEDs .....                                | 19 |
| Table 3. 10/100Base-TX Port LEDs .....                    | 20 |
| Table 4. Uplink Combo Port LEDs .....                     | 20 |
| Table 5. Twisted Pair Cabling and Distances .....         | 29 |
| Table 6. MDI Pin Signals (10Base-T or 100Base-TX) .....   | 42 |
| Table 7. MDI-X Pin Signals (10Base-T or 100Base-TX) ..... | 43 |
| Table 8. RJ-45 1000Base-T Connector Pinouts .....         | 43 |



# Preface

---

This guide contains installation instructions for the AT-FS750/16 and AT-FS750/24 Fast Ethernet Smart Switches. This preface contains the following sections:



- “Safety Symbols Used in this Document” on page 12
- “Where to Find Web-based Guides” on page 13
- “Contacting Allied Telesis” on page 14

## Safety Symbols Used in this Document

---

This document uses the safety symbols defined in Table 1.

Table 1. Safety Symbols

| Symbol  | Meaning | Description  |
|---|---------|--|
|  | Caution | Performing or omitting a specific action may result in equipment damage or loss of data. |
|  | Warning | Performing or omitting a specific action may result in electrical shock.                 |

## Where to Find Web-based Guides

---

The installation and user guides for all Allied Telesis products are available in portable document format (PDF) on our web site at **[www.alliedtelesis.com](http://www.alliedtelesis.com)**. You can view the documents online or download them onto a local workstation or server.

## Contacting Allied Telesis

---

This section provides Allied Telesis contact information for technical support as well as sales and corporate information.

### Online Support

You can request technical support online by accessing the Allied Telesis Knowledge Base: [www.alliedtelesis.com/support/kb.aspx](http://www.alliedtelesis.com/support/kb.aspx). You can use the Knowledge Base to submit questions to our technical support staff and review answers to previously asked questions.

### Email and Telephone Support

For Technical Support via email or telephone, refer to the Support section of the Allied Telesis web site: [www.alliedtelesis.com](http://www.alliedtelesis.com).

### Returning Products

Products for return or repair must first be assigned a return materials authorization (RMA) number. A product sent to Allied Telesis without an RMA number will be returned to the sender at the sender's expense. For instructions on how to obtain an RMA number, go to the Support section on our web site at [www.alliedtelesis.com](http://www.alliedtelesis.com).

### Sales or Corporate Information

You can contact Allied Telesis for sales or corporate information through our web site at [www.alliedtelesis.com](http://www.alliedtelesis.com).

### Warranty

The AT-FS750/16 and AT-FS750/24 Switches have a Lifetime Warranty (24 Months Fan and PSU). Go to [www.alliedtelesis.com/warranty](http://www.alliedtelesis.com/warranty) for the terms and conditions of the warranty and for warranty registration.

### Management Software Updates

New releases of the management software for our managed products are available from the following Internet sites:

- Allied Telesis web site: [www.alliedtelesis.com](http://www.alliedtelesis.com)
- Allied Telesis FTP server: <ftp://ftp.alliedtelesis.com>

If the FTP server prompts you to log on, enter "anonymous" as the user name and your email address as the password.

## Chapter 1

# Overview

---

This chapter describes the AT-FS750/16 and AT-FS750/24 Layer 2 Fast Ethernet Smart Switches. The sections in the chapter are:

- ❑ “Features” on page 16
- ❑ “Front and Back Panels” on page 17
- ❑ “Ports” on page 18
- ❑ “LEDs” on page 19
- ❑ “Power Supply” on page 21
- ❑ “Network Topologies” on page 22

## Features

---

The features of the AT-FS750/16 and AT-FS750/24 Fast Ethernet Smart Switches include:

- ❑ LEDs for unit and port status
- ❑ 16 or 24 Auto-Negotiating 10/100Base-T twisted pair ports with RJ-45 connectors
- ❑ Two pairs of uplink combo ports, with each pair consisting of one 10/100/1000Base-T twisted pair port and one slot for an optional Gigabit small form-factor pluggable (SFP) transceiver
- ❑ Auto MDI/MDI-X on the twisted pair ports
- ❑ IEEE 802.3 and IEEE 802.3u compliant
- ❑ IEEE 802.3x flow control in full-duplex operation; back pressure in half-duplex operation
- ❑ IEEE 802.1P based Quality of Service support
- ❑ IEEE 802.1Q based tagged up to 4K VLAN support
- ❑ IEEE 802.1X based authentication
- ❑ Port mirroring
- ❑ Link aggregation
- ❑ Store and forward switching mode
- ❑ Dynamic Host Configuration Protocol (DHCP) client
- ❑ 8K MAC address table with automatic aging
- ❑ Menus- and web-based configuration using the AT-S80 Management Software



## Front and Back Panels

Figure 1 illustrates the front panels of the AT-FS750/16 and AT-FS750/24 Fast Ethernet Smart Switches.

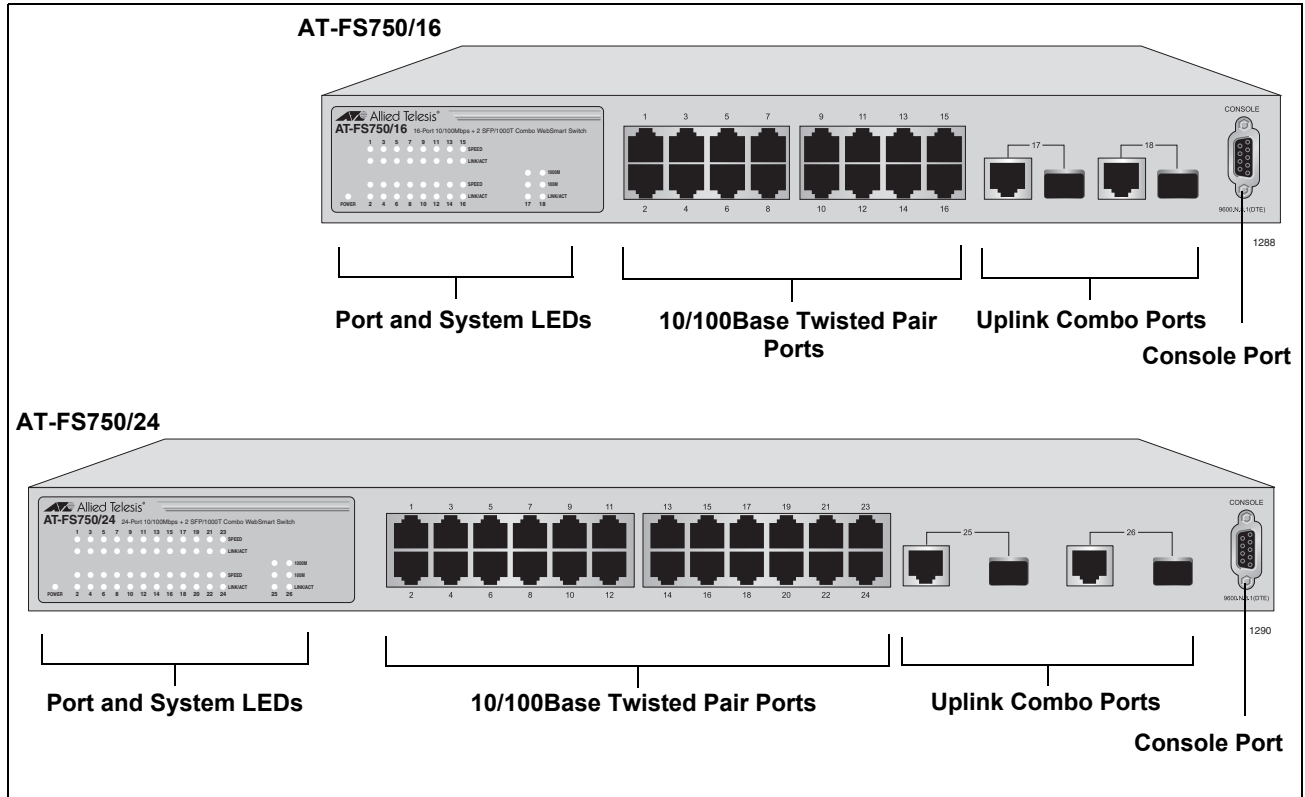

Figure 1. AT-FS750/16 and AT-FS750/24 Front Panels

Figure 2 illustrates the back panel of the AT-FS750/16 and AT-FS750/24 Fast Ethernet Smart Switches.

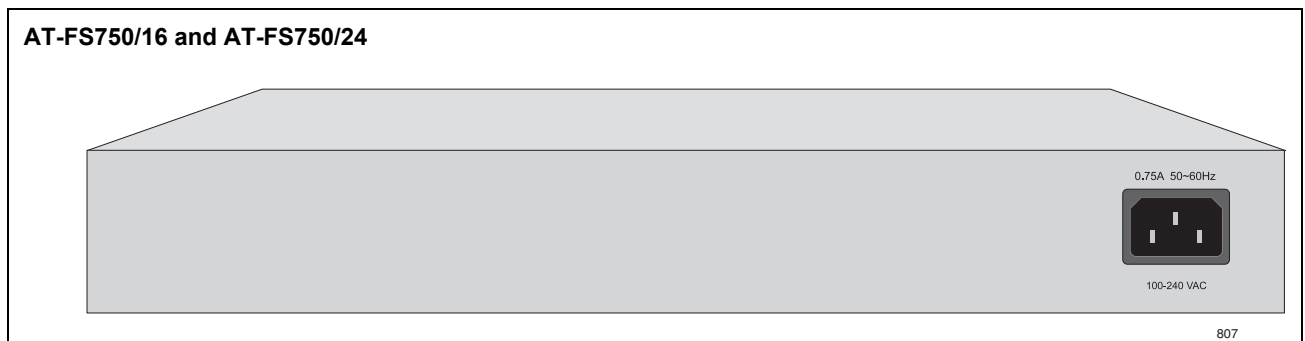

Figure 2. AT-FS750/16 and AT-FS750/24 Back Panels

## Ports

---

The AT-FS750/16 and AT-FS750/24 Fast Ethernet Smart Switches feature 16 or 24 twisted pair ports and two pairs of uplink combo ports.

### Twisted Pair Ports

The twisted pair ports are 10Base-T and 100Base-TX compliant. They automatically set their speed and duplex mode with IEEE 802.3u Auto-Negotiation. If desired, you can disable Auto-Negotiation on a port and manually set the speed and duplex mode.

---

#### Note

If a switch port is connected to an end node that is not using Auto-Negotiation, you should disable Auto-Negotiation on the port and set its speed and duplex mode manually. Otherwise, a duplex mode mismatch can occur.

---

The ports have 8-pin RJ-45 connectors. For the port pinouts, refer to “Connectors and Port Pinouts” on page 42.

The ports have a maximum operating distance of 100 m (328 feet). For 10 Mbps operation, the ports require Category 3 or better 100 ohm shielded or unshielded twisted pair cabling. For 100 Mbps operation, the ports require Category 5 or Enhanced Category 5 (5E) 100 ohm shielded or unshielded twisted pair cabling.

Also featured on the ports is auto-MDI, which automatically configures the ports as MDI or MDI-X. This allows you to use straight-through twisted pair cable regardless of the configuration of the ports on the end nodes.

### Uplink Combo Ports

The switch has two pairs of uplink ports, each consisting of one 10/100/1000Base-T twisted pair port and one slot for an optional SFP transceiver. The ports are numbered 17 and 18 on the AT-FS750/16 Switch and 25 and 26 on the AT-FS750/24 Switch. These combo ports can be used to connect high speed devices to your network or to connect devices over large distances.

You can use one port in a combo pair at a time. A link on an SFP transceiver always takes precedence over a link on a 10/100/1000Base-T twisted pair port in the same combo pair. If the SFP slot is empty or if it has an SFP module but the module does not have a link to an end node, the 10/100/1000Base-T twisted pair port of the pair is active. If an SFP transceiver is installed and has a link to an end node, the twisted pair port in the pair is inactive.

### RS-232 Console Port

The RS-232 console port is for local management of the switch with the AT-S80 Management Software. Local management uses the management cable supplied with the switch.

# LEDs

The LEDs shown in Figure 3 display system and port status information.

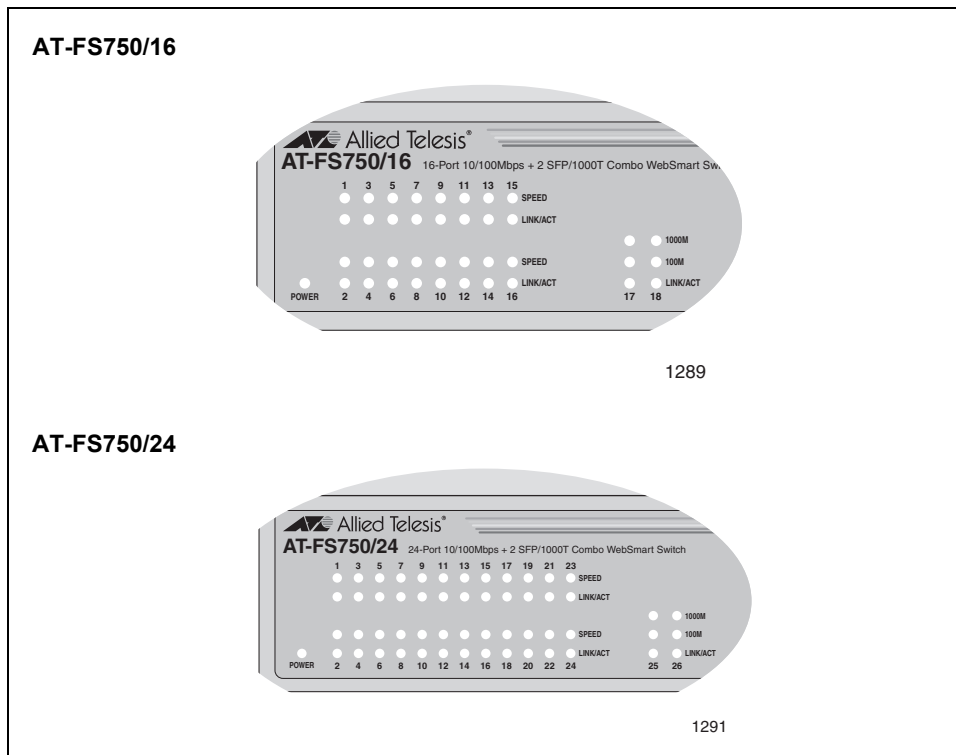

Figure 3. AT-FS750/16 and FS750/24 System and Port LEDs

Table 2 describes the system LEDs.

Table 2. System LEDs

| LED   | State | Description                        |
|-------|-------|------------------------------------|
| POWER | Off   | The switch is not receiving power. |
|       | On    | The switch is receiving power.     |

Each of the 10/100Base-TX ports has two LEDs, described in Table 3.

Table 3. 10/100Base-TX Port LEDs

| LED      | State          | Description   |
|----------|----------------|---|
| SPEED    | On             | The port is operating at 100 Mbps.  |
|          | Off            | The port is operating at 10 Mbps or it has not established a link to an end node. |
| LINK/ACT | Green          | The port has established a valid link.  |
|          | Blinking Green | The port is transmitting or receiving data.                                       |
|          | Off            | No link is established on the port.   |

Table 4 describes the LEDs for the uplink combo ports.

Table 4. Uplink Combo Port LEDs

| LED      | State              | Description  |
|----------|--------------------|--|
| 1000M    | Green              | The uplink port has established a valid 1000 Mbps link with an end node.       |
|          | Off <sup>1</sup>   | No 1000 Mbps link is established on the uplink port.                           |
| 100M     | Green              | A valid 100 Mbps link is established between the uplink port and the end node. |
|          | Off <sup>1</sup>   | No 100 Mbps link is established on the uplink port.                            |
| LINK/ACT | Green <sup>1</sup> | A valid link is established on the uplink port.                                |
|          | Blinking Green     | The uplink port is transmitting or receiving data.                             |
|          | Off                | No link is established on the port.  |

1. The port has established a valid 10 Mbps link when both the 1000M and the 100M LEDs are Off and the LINK/ACT LED is Green.

## Power Supply

---

The switches have an internal power supply with a single AC power supply socket featuring autoswitch AC inputs on the back panel. To power the switch on or off, connect or disconnect the power cord provided with the switch. A power cord is supplied with the switch.

---

**Note**

For the power requirements, refer to “Power Specifications” on page 41.

---

## Network Topologies

This section illustrates two network topologies of the AT-FS750/16 and AT-FS750/24 Fast Ethernet Smart Switches: a power workgroup and collapsed backbone.

### Power Workgroup Topology

The topology shown in Figure 4 is commonly referred to as a power workgroup. This topology provides the best in performance and reliability because each end node is connected directly to the AT-FS750/24 Switch with a dedicated network link.

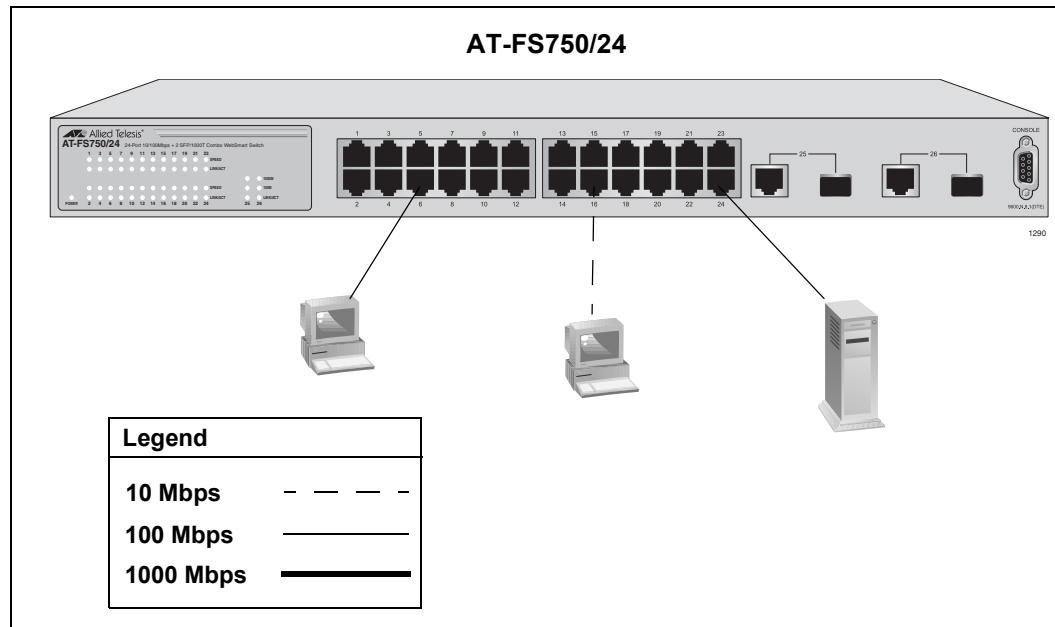

Figure 4. Power Workgroup Topology

**Collapsed Backbone**

In the topology shown in Figure 5 the AT-FS750/16 Switch is connected to other managed and unmanaged Ethernet switches to form a collapsed backbone topology. The AT-FS750/16 Switch functions as the focal point of the network by transferring Ethernet frames between the switches. This topology reduces the amount of unnecessary traffic in each workgroup, because the AT-FS750/16 Switch transfers frames only when the source and destination end nodes are located on different switches. This frees up bandwidth and improves network performance.

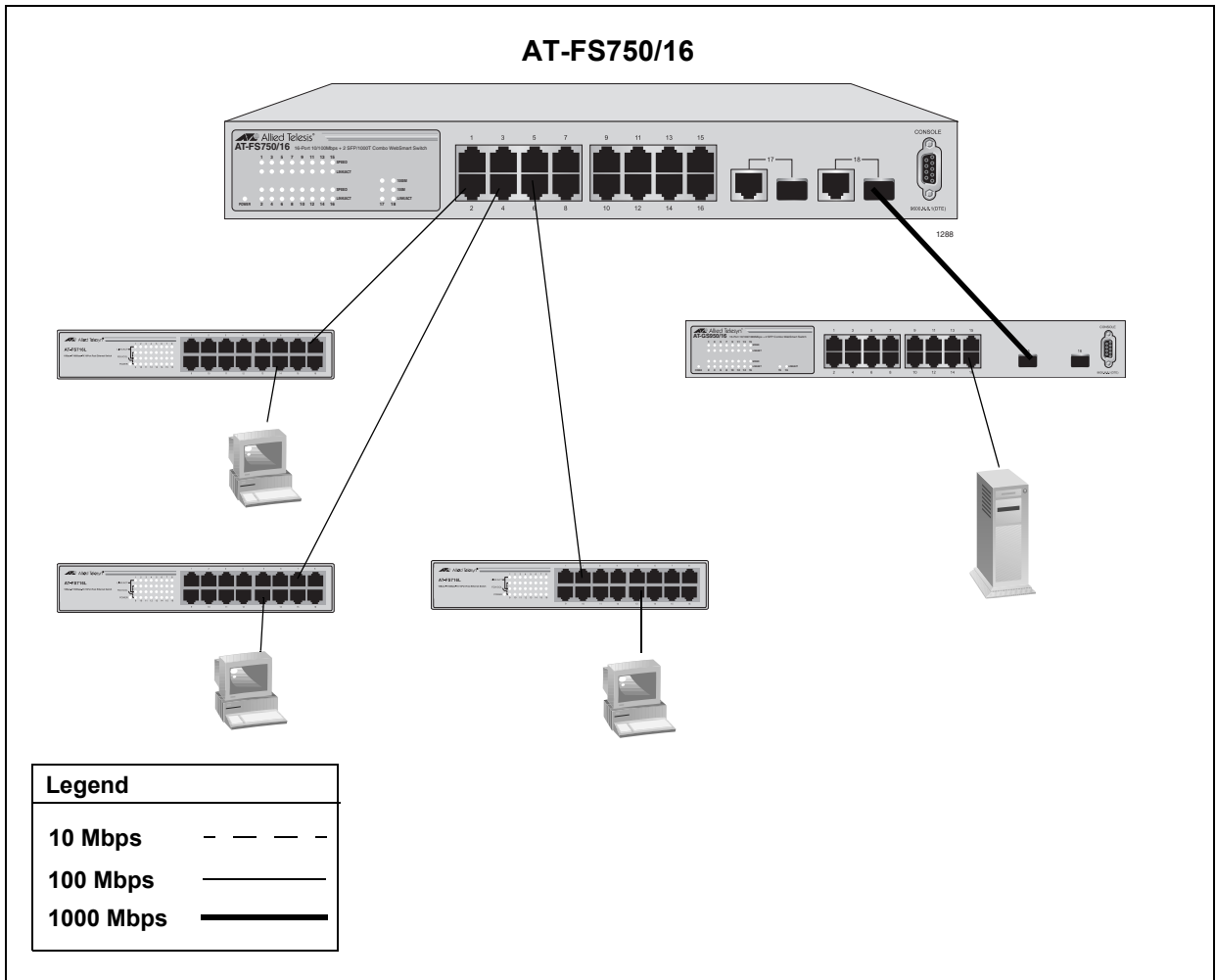

Figure 5. Collapsed Backbone Topology





## Chapter 2

# Installation

---

This chapter contains the following sections:

- ❑ “Reviewing Safety Precautions” on page 26
- ❑ “Selecting a Site for the Switch” on page 28
- ❑ “Cable Specifications” on page 29
- ❑ “Unpacking the Switch” on page 30
- ❑ “Installing the Switch on a Desktop” on page 31
- ❑ “Installing the Switch in an Equipment Rack” on page 32
- ❑ “Installing an Optional SFP Transceiver” on page 34
- ❑ “Cabling the Switch” on page 37
- ❑ “Powering On the Switch” on page 38

## Reviewing Safety Precautions

---

Please review the following safety precautions before you begin to install the chassis or any of its components.

---

### Note

The  indicates that a translation of the safety statement is available in a PDF document titled “Translated Safety Statements” (613-000405) posted on the Allied Telesis website at [www.alliedtelesis.com](http://www.alliedtelesis.com).

---



**Warning:** To prevent electric shock, do not remove the cover. No user-serviceable parts inside. This unit contains hazardous voltages and should only be opened by a trained and qualified technician. To avoid the possibility of electric shock, disconnect electric power to the product before connecting or disconnecting the LAN cables.  E1

---



**Warning:** Do not work on equipment or cables during periods of lightning activity.  E2

---



**Warning:** Power cord is used as a disconnection device. To de-energize equipment, disconnect the power cord.  E3

---



**Warning:** Class I Equipment. This equipment must be earthed. The power plug must be connected to a properly wired earth ground socket outlet. An improperly wired socket outlet could place hazardous voltages on accessible metal parts.  E4

---

Pluggable Equipment. The socket outlet shall be installed near the equipment and shall be easily accessible.  E5

---



**Caution:** Air vents must not be blocked and must have free access to the room ambient air for cooling.  E6

---

**Warning:** Operating Temperature. This product is designed for a maximum ambient temperature of 40° degrees C.  E7

---

All Countries: Install product in accordance with local and National Electrical Codes.  E8

---

---

Circuit Overloading: Consideration should be given to the connection of the equipment to the supply circuit and the effect that overloading of circuits might have on overcurrent protection and supply wiring. Appropriate consideration of equipment nameplate ratings should be used when addressing this concern. *↪* E21

---



**Warning:** Mounting of the equipment in the rack should be such that a hazardous condition is not created due to uneven mechanical loading. *↪* E25

---

If installed in a closed or multi-unit rack assembly, the operating ambient temperature of the rack environment may be greater than the room ambient temperature. Therefore, consideration should be given to installing the equipment in an environment compatible with the manufacturer's maximum rated ambient temperature ( $T_{mra}$ ). *↪* E35

---

**Caution:** Installation of the equipment in a rack should be such that the amount of air flow required for safe operation of the equipment is not compromised. *↪* E36

---



**Warning:** Reliable earthing of rack-mounted equipment should be maintained. Particular attention should be given to supply connections other than direct connections to the branch circuits (e.g., use of power strips). *↪* E37

---

## Selecting a Site for the Switch

---

Observe the following requirements when choosing a site for your switch:

- ❑ If you plan to install the switch in an equipment rack, ensure that the rack is safely secured and that it will not tip over. Devices in a rack should be installed starting at the bottom, with the heavier devices near the bottom of the rack.
- ❑ If you are installing the switch on a table, ensure that the table is level and secure.
- ❑ The power outlet for the switch should be located near the unit and should be easily accessible.
- ❑ The site should provide for easy access to the ports on the front of the switch. This will make it easier for you to connect and disconnect cables, as well as view the switch's LEDs.
- ❑ To allow proper cooling of the switch, air flow around the unit and through its vents on the side and rear should not be restricted.
- ❑ Do not place objects on top of the switch.
- ❑ Do not expose the switch to moisture or water.
- ❑ Ensure that the site is a dust-free environment.
- ❑ You should use dedicated power circuits or power conditioners to supply reliable electrical power to the network devices.

## Cable Specifications

---

Table 5 lists the cable specifications for the twisted pair ports.

Table 5. Twisted Pair Cabling and Distances

| Speed     | Type of Cable  | Maximum Operating Distance |
|-----------|--|----------------------------|
| 10 Mbps   | Standard TIA/EIA 568-B-compliant Category 3 or better shielded or unshielded cabling with 100 ohm impedance and a frequency of 16 MHz.   | 100 m (328 ft)             |
| 100 Mbps  | Standard TIA/EIA 568-A-compliant Category 5 or TIA/EIA 568-B-compliant Enhanced Category 5 (Cat 5e) shielded or unshielded cabling with 100 ohm impedance and a frequency of 100 MHz.  | 100 m (328 ft)             |
| 1000 Mbps | Standard TIA/EIA 568-A-compliant Category 5 or TIA/EIA 568-B-compliant Enhanced Category 5 (Cat 5e) shielded or unshielded cabling with 100 ohm impedance and a frequency of 100 MHz.<br><br>This speed applies only to the two 10/100/1000Base-T ports. | 100 m (328 ft)             |

---

### Note

The twisted pair ports on the switch feature auto-MDI when operating at 10, 100 or 1000 Mbps. A port is automatically configured as MDI or MDI-X when connected to an end node. Consequently, you can use straight-through twisted pair cable when connecting any type of network device to a port on the switch.

---

## Unpacking the Switch

---

To unpack the switch, perform the following procedure:

1. Remove all components from the shipping package.

---

**Note**

Store the packaging material in a safe location. You must use the original shipping material if you need to return the unit to Allied Telesis.

---

2. Place the switch on a level, secure surface.
3. Verify that the switch package has the following hardware components. If any item is missing or damaged, contact your Allied Telesis sales representative for assistance.
  - One AT-FS750/16 or AT-FS750/24 Smart Switch
  - Two rack-mount brackets
  - Eight rack-mount bracket screws (black)
  - Four rack-mounting screws (stainless steel)
  - Four rubber feet (for desktop use)
  - One management cable
  - One power cord
  - Documentation CD

## Installing the Switch on a Desktop

You can install the AT-FS750/16 and AT-FS750/24 Fast Ethernet Smart Switches on a desktop or in a standard 19-inch equipment rack. To install the switch in a rack, refer to “Installing the Switch in an Equipment Rack” on page 32.

To place the switch on a desktop, perform the following procedure:

1. Remove all equipment from the package and store the packaging material in a safe place.
2. Turn the switch over and attach the four rubber feet to the bottom of the switch as shown in Figure 6.

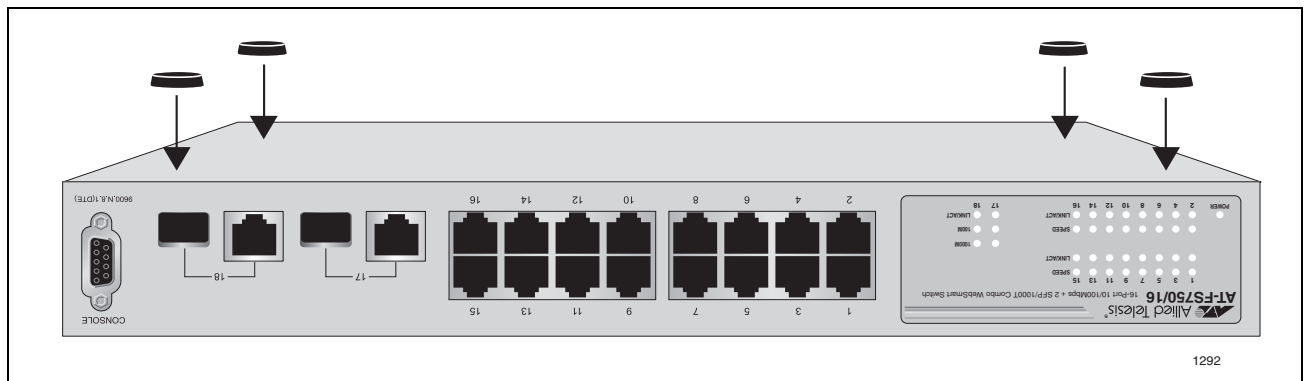

Figure 6. Attaching the Rubber Feet

3. Turn the switch over again and place it on a flat, secure surface (such as a desk or table) leaving ample space around the unit for ventilation.

## Installing the Switch in an Equipment Rack

To install the switch in a standard 19-inch equipment rack, perform the following procedure:

1. If attached, remove the rubber feet using a flat-head screwdriver.
2. Install a rack-mount bracket on one side of the switch using a Phillips screwdriver and four of the rack-mount screws included with the switch. Figure 7 and Figure 8 illustrate installing the brackets on the AT-FS750/16 and AT-FS750/24 Switches, respectively.

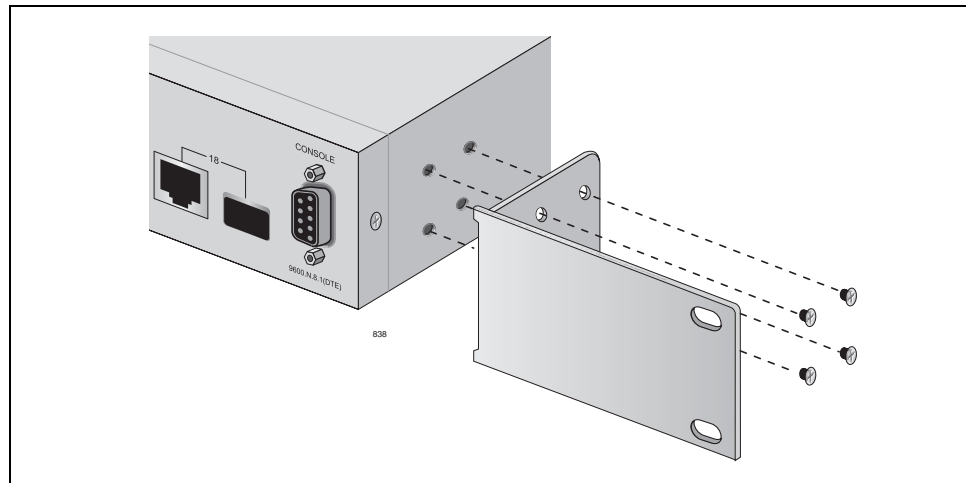

Figure 7. Attaching the Rack-Mount Bracket to the AT-FS750/16 Switch

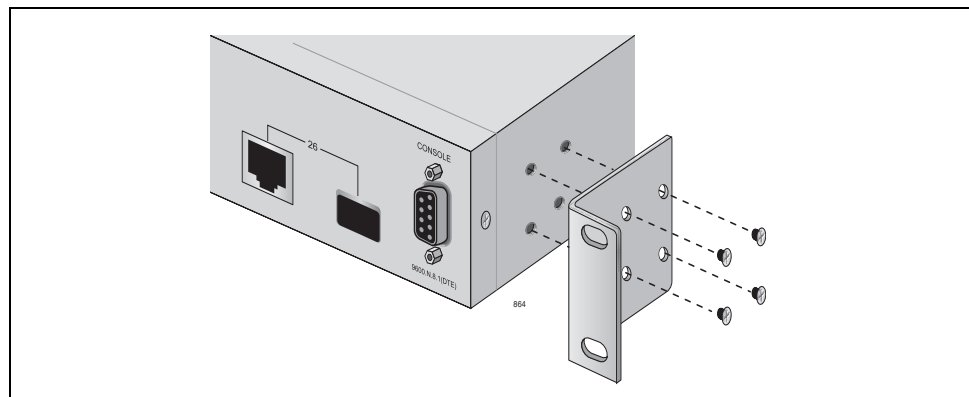

Figure 8. Attaching the Rack-Mount Bracket to the AT-FS750/24 Switch

3. Repeat step 2 to attach the remaining bracket to the other side of the switch.



4. Mount the switch in a standard 19-inch equipment rack using the four large screws included. Figure 9 and Figure 10 show how to mount the AT-FS750/16 and AT-FS750/24 Switches, respectively.

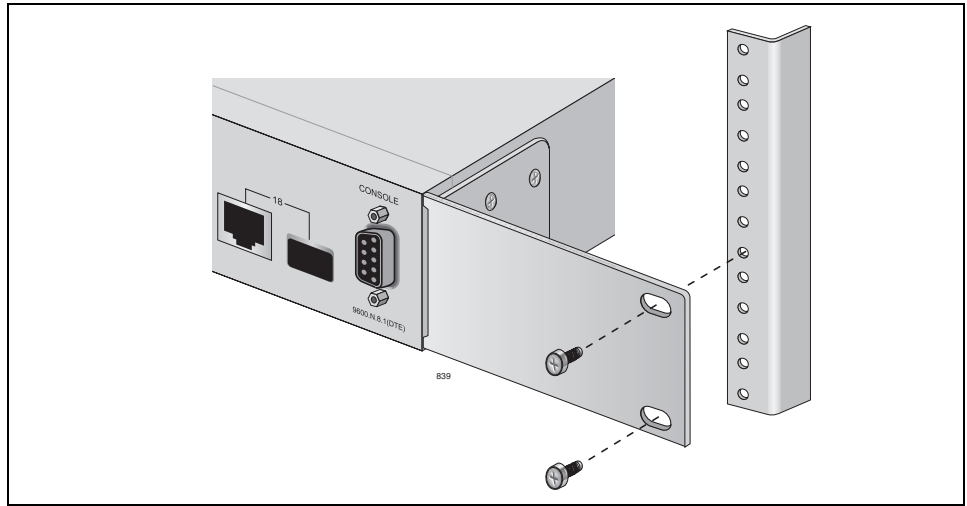

Figure 9. Mounting the AT-FS750/16 Switch in an Equipment Rack

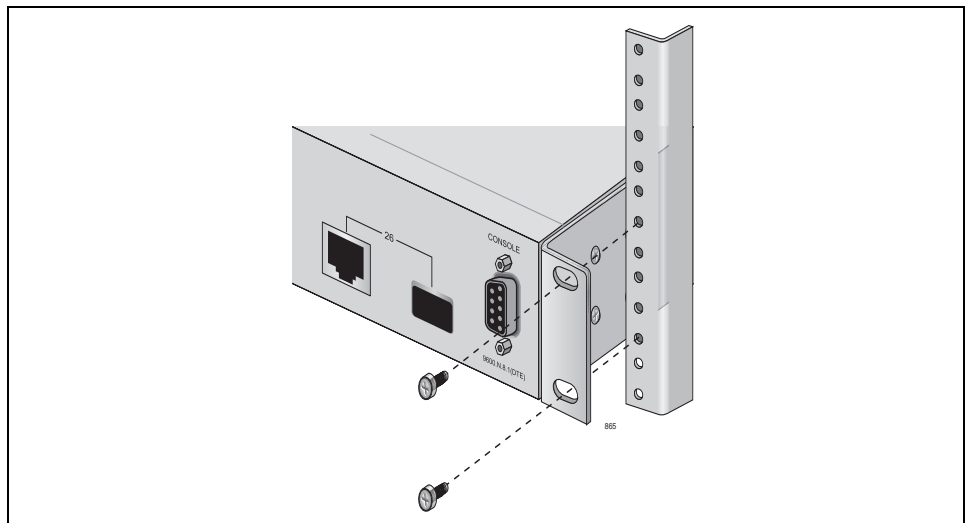

Figure 10. Mounting the AT-FS750/24 Switch in an Equipment Rack

## Installing an Optional SFP Transceiver

The AT-FS750/16 and AT-FS750/24 Fast Ethernet Smart Switches have two slots for optional SFP transceivers. To install an SFP transceiver, perform the following procedure:

---

**Note**

The transceiver can be hot-swapped; you do not need to power off the switch to install a transceiver. However, always remove the cables before removing the transceiver.

---

---

**Note**

You should always install the transceiver before connecting the fiber optic cables to it.

---

1. Remove the transceiver from its shipping container and store the packaging material in a safe location.

**Warning**

An SFP transceiver can be damaged by static electricity. Be sure to observe all standard electrostatic discharge (ESD) precautions, such as wearing an antistatic wrist strap, to avoid damaging the transceiver.

---

2. Remove the dust plug from an SFP slot, as shown in Figure 11.

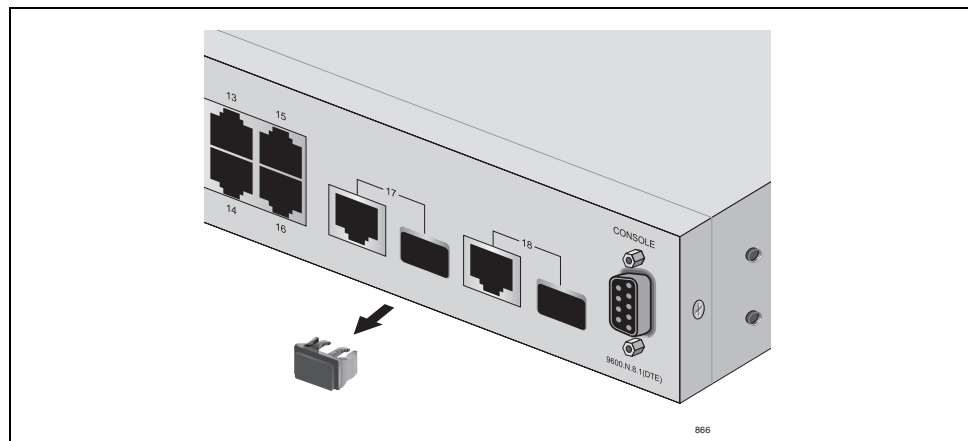

Figure 11. Removing the Dust Plug from the SFP Slot

3. Position the SFP transceiver with the label facing up.

- Slide the transceiver into the SFP slot until it clicks into place.

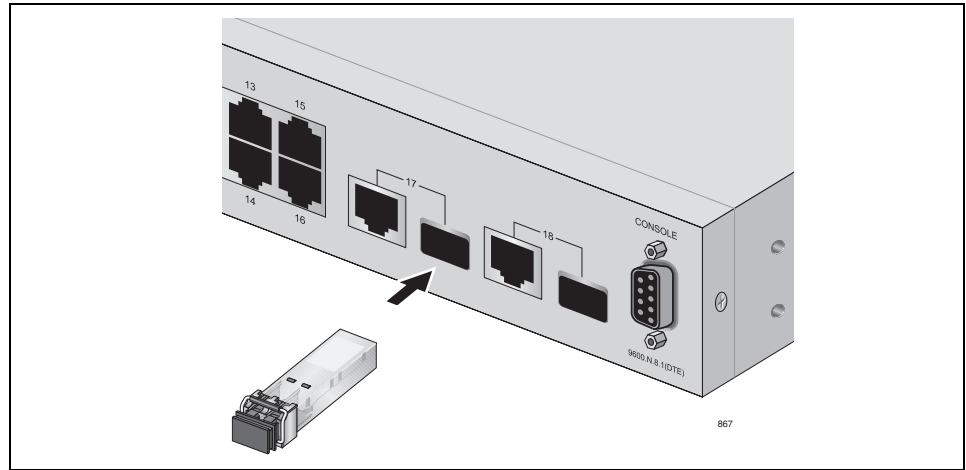

Figure 12. Inserting the SFP

- Verify that the handle on the transceiver is in the upright position, as shown in Figure 13. This secures the transceiver and prevents it from being dislodged from the slot.

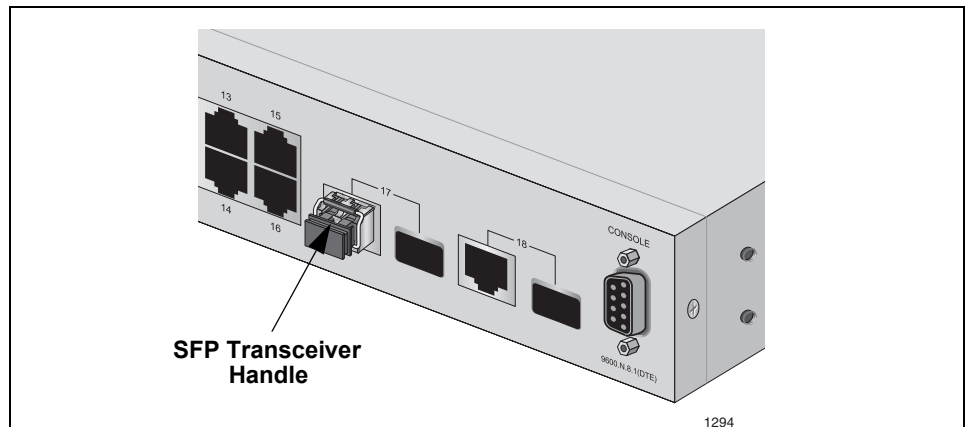

Figure 13. Positioning the SFP Handle in the Upright Position

- Repeat steps 2 through 5 to install another SFP transceiver.

---

**Note**

SFP transceivers are dust sensitive. When a fiber optic cable is not installed, or when you store the SFP, always keep the plug in the optical bores. When you do remove the plug, keep it for future use.

---



---

**Note**

Unnecessary removal and insertion of an SFP can lead to premature failure.

---

For information on the cable specifications of the SFP transceiver, consult the documentation shipped with the device.

## Cabling the Switch

---

Observe the following guidelines when connecting twisted pair and fiber optic cables to the ports on the switch:

- ❑ The connector on the cable should fit snugly into the port on the switch. The tab on the connector should lock the connector into place.
- ❑ Because the twisted pair ports have auto-MDI/MDI-X, you can use straight-through twisted pair cable to connect any type of network device to the switch.
- ❑ If your network topology contains a loop where two or more network devices can communicate with each other over more than one network path, do not connect the network cables forming the loop until after you have activated the Rapid Spanning Tree Protocol on the switch. Data loops can adversely affect network performance.
- ❑ If you are creating a port trunk, configure the switch's management software before connecting the cables of the trunk to the switch. Otherwise, a network loop will result which can adversely affect network performance.
- ❑ In order for a switch port to successfully Auto-Negotiate its duplex mode with an end node, the end node should also be using Auto-Negotiation. Otherwise, a duplex mode mismatch can occur. A switch port using Auto-Negotiation defaults to half-duplex if it detects that the end node is not using Auto-Negotiation. This can result in a mismatch if the end node is operating at a fixed duplex mode of full-duplex.

To avoid this problem, disable Auto-Negotiation on a switch port and set the port's speed and duplex mode manually if the end node has a fixed duplex mode of full-duplex.

## Powering On the Switch

---

To power on the switch, perform the following procedure:

1. Plug the power cord into the AC power connector on the back of the switch, as shown in Figure 14.

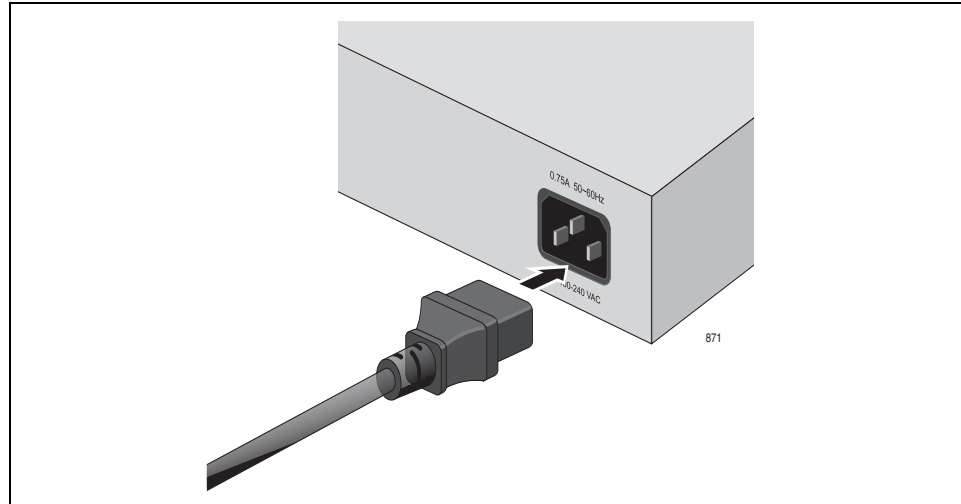

Figure 14. Plugging in the AC Power Cord

2. Plug the other end of the power cord into a wall outlet.



**Warning:** Power cord is used as a disconnection device. To de-energize equipment, disconnect the power cord. ⚡ E3

---

Pluggable Equipment. The socket outlet shall be installed near the equipment and shall be easily accessible. ⚡ E5

---

3. Verify that the POWER LED is green. If the LED is OFF, refer to Chapter 3, “Troubleshooting” on page 39.

The switch is now powered on and ready for network operations. For information on how to manage the switch, refer to the *AT-S80 Management Software User’s Guide*.

## Chapter 3

# Troubleshooting

---

This chapter contains information on how to troubleshoot the switch if a problem occurs.

---

**Note**

For further assistance, please contact Allied Telesis Technical Support. Refer to “Contacting Allied Telesis” on page 14.

---

Check the POWER LED on the front of the switch. If the LED is off, indicating that the unit is not receiving power, do the following:

- Ensure that the power cord is securely connected to the power source and to the AC connector on the back panel of the switch.
- Verify that the power outlet has power by connecting another device to it.
- Connect the unit to another power source.
- Use a different power cord.
- Verify that the voltage from the power source is within the required levels for your region.

Verify that the LINK/ACT LED for each port is ON. If a LINK/ACT LED is OFF, do the following:

- Verify that the end node connected to the port is powered on and is operating properly.
- Verify that the twisted pair cable is securely connected to the port on the switch and to the port on the end node.
- Ensure that the twisted pair cable does not exceed 100 meters (328 feet).
- Verify that you are using the appropriate category of twisted pair cable: Category 3 or better for 10 Mbps operation and Category 5 and Category 5E for 100 and 1000 Mbps operation.

---

**Note**

A 1000Base connection may require five to ten seconds to establish a link.

---





## Appendix A

# Technical Specifications

---

## Physical Specifications

---

|             |             |  |
|-------------|-------------|--|
| Dimensions: | AT-FS750/16 | 330 mm x 230.7 mm x 43.2 mm<br>(12.99 in x 9.08 in x 1.7 in) |
|             | AT-FS750/24 | 440 mm x 257 mm x 43.2 mm<br>(17.32 in x 10.12 in x 1.7 in)  |
| Weight:     | AT-FS750/16 | 2.22 kg (4.9 lbs)  |
|             | AT-FS750/24 | 3.06 kg (6.75 lbs)   |

## Environmental Specifications

---

|                           |                                    |
|---------------------------|------------------------------------|
| Operating Temperature:    | 0° C to 40° C (32° F to 104° F)    |
| Storage Temperature:      | -25° C to 70° C (-13° F to 158° F) |
| Operating Humidity:       | 5% to 90% non-condensing           |
| Storage Humidity:         | 5% to 95% non-condensing           |
| Operating Altitude Range: | Up to 3,000 m (9,843 ft)           |

## Power Specifications

---

|                       |                           |            |
|-----------------------|---------------------------|------------|
| Input Supply Voltage: | 100 - 240 VAC, 50 - 60 Hz |            |
| Power Consumption:    | AT-FS750/16               | 12.5 Watts |
|                       | AT-FS750/24               | 15 Watts   |

## Safety and Electromagnetic Emissions Certifications

---

|                    |   |
|--------------------|---|
| EMI/RFI:           | FCC Class A, EN55022 Class A, CISPR Class A, C-TICK, CE |
| Immunity:          | EN55024   |
| Electrical Safety: | EN60950 (TUV), UL60950 (cUL <sub>us</sub> )             |

## Connectors and Port Pinouts

---

This section lists the connectors and connector pinouts for the AT-GS950/16 and AT-GS950/24 switches and their components.

Figure 15 illustrates the pin layout for an RJ-45 connector and port.

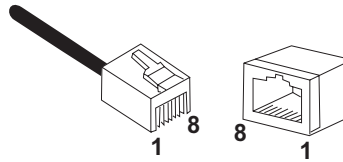

Figure 15. RJ-45 Connector and Port Pin Layout

Table 6 lists the RJ-45 pin signals when a twisted pair port is operating in the MDI configuration.

Table 6. MDI Pin Signals (10Base-T or 100Base-TX)

| Pin | Signal |
|-----|--------|
| 1   | TX+    |
| 2   | TX-    |
| 3   | RX+    |
| 6   | RX-    |

Table 7 lists the RJ-45 port pin signals when a twisted pair port is operating in the MDI-X configuration.

Table 7. MDI-X Pin Signals (10Base-T or 100Base-TX)

| Pin | Signal |
|-----|--------|
| 1   | RX+    |
| 2   | RX-    |
| 3   | TX+    |
| 6   | TX-    |

Table 8 lists the RJ-45 connector pins and their signals when a 1000Base-T port is operating at 1000 Mbps.

Table 8. RJ-45 1000Base-T Connector Pinouts

| Pin | Pair | Signal     |
|-----|------|------------|
| 1   | 1    | TX and RX+ |
| 2   | 1    | TX and RX- |
| 3   | 2    | TX and RX+ |
| 4   | 3    | TX and RX+ |
| 5   | 3    | TX and RX- |
| 6   | 2    | TX and RX- |
| 7   | 4    | TX and RX+ |
| 8   | 4    | TX and RX- |

